

International Standards
and Recommended Practices



Annex 10
to the Convention on
International Civil Aviation

Aeronautical Telecommunications

Volume IV
Surveillance and Collision Avoidance Systems

This edition incorporates all amendments adopted by the Council prior to 4 March 2014 and supersedes, on 13 November 2014, all previous editions of Annex 10, Volume IV.

For information regarding the applicability of the Standards and Recommended Practices, see Foreword.

Fifth Edition
July 2014

International Civil Aviation Organization

**International Standards
and Recommended Practices**



Annex 10
to the Convention on
International Civil Aviation

Aeronautical Telecommunications

Volume IV
Surveillance and Collision Avoidance Systems

This edition incorporates all amendments adopted by the Council prior to 4 March 2014 and supersedes, on 13 November 2014, all previous editions of Annex 10, Volume IV.

For information regarding the applicability of the Standards and Recommended Practices, see Foreword.

Fifth Edition
July 2014

International Civil Aviation Organization

Published in separate English, French, Russian and Spanish editions by the
INTERNATIONAL CIVIL AVIATION ORGANIZATION
999 Robert-Bourassa Boulevard, Montréal, Quebec, Canada H3C 5H7

For ordering information and for a complete listing of sales agents
and booksellers, please go to the ICAO website at www.icao.int

First Edition, 1995
Fourth Edition, 2007
Fifth Edition, 2014

Annex 10 — Aeronautical Telecommunications
Volume IV — Surveillance and Collision Avoidance Systems

Order Number: AN 10-4
ISBN 978-92-9249-537-4 (print version)
ISBN 978-92-9265-730-7 (electronic version)

© ICAO 2014

All rights reserved. No part of this publication may be reproduced, stored in a
retrieval system or transmitted in any form or by any means, without prior
permission in writing from the International Civil Aviation Organization.

AMENDMENTS

Amendments are announced in the supplements to the *Publications Catalogue*; the Catalogue and its supplements are available on the ICAO website at www.icao.int. The space below is provided to keep a record of such amendments.

RECORD OF AMENDMENTS AND CORRIGENDA

AMENDMENTS			
No.	Date applicable	Date entered	Entered by
70-89	Incorporated in this edition		
90	8/11/18	16/7/18	ICAO
91	3/11/22	18/7/22	ICAO

CORRIGENDA			
No.	Date of issue	Date entered	Entered by

TABLE OF CONTENTS

	<i>Page</i>
Foreword	(vii)
Chapter 1. Definitions	1-1
Chapter 2. General	2-1
2.1 Secondary surveillance radar (SSR)	2-1
2.2 Human Factors considerations	2-6
Chapter 3. Surveillance systems	3-1
3.1 Secondary surveillance radar (SSR) system characteristics	3-1
Appendix to Chapter 3. SSR automatic pressure-altitude transmission code (pulse position assignment)	3-94
Chapter 4. Airborne collision avoidance system	4-1
4.1 Definitions relating to airborne collision avoidance system	4-1
4.2 ACAS I general provisions and characteristics	4-3
4.3 General provisions relating to ACAS II and ACAS III	4-5
4.4 Performance of the ACAS II collision avoidance logic	4-41
4.5 ACAS use of extended squitter	4-57
Chapter 5. Mode S extended squitter	5-1
5.1 Mode S extended squitter transmitting system characteristics	5-1
5.2 Mode S extended squitter receiving system characteristics (ADS-B in and TIS-B in)	5-3
Chapter 6. Multilateration systems	6-1
6.1 Definitions	6-1
6.2 Functional requirements	6-1
6.3 Protection of the radio frequency environment	6-2
6.4 Performance requirements	6-2
Chapter 7. Technical requirements for airborne surveillance applications	7-1
7.1 General requirements	7-1

FOREWORD

Historical background

Standards and Recommended Practices for Aeronautical Telecommunications were first adopted by the Council on 30 May 1949 pursuant to the provisions of Article 37 of the Convention on International Civil Aviation (Chicago 1944) and designated as Annex 10 to the Convention. They became effective on 1 March 1950. The Standards and Recommended Practices were based on recommendations of the Communications Division at its Third Session in January 1949.

Up to and including the Seventh Edition, Annex 10 was published in one volume containing four Parts together with associated attachments: Part I — Equipment and Systems, Part II — Radio Frequencies, Part III — Procedures, and Part IV — Codes and Abbreviations.

By Amendment 42, Part IV was deleted from the Annex; the codes and abbreviations contained in that Part were transferred to a new document, Doc 8400.

As a result of the adoption of Amendment 44 on 31 May 1965, the Seventh Edition of Annex 10 was replaced by two volumes: Volume I (First Edition) containing Part I — Equipment and Systems, and Part II — Radio Frequencies, and Volume II (First Edition) containing Communication Procedures.

As a result of the adoption of Amendment 70 on 20 March 1995, Annex 10 was restructured to include five volumes: Volume I — Radio Navigation Aids; Volume II — Communication Procedures; Volume III — Communication Systems; Volume IV — Surveillance Radar and Collision Avoidance Systems; and Volume V — Aeronautical Radio Frequency Spectrum Utilization. By Amendment 70, Volumes III and IV were published in 1995 and Volume V was planned for publication with Amendment 71.

Table A shows the origin of amendments to Annex 10, Volume IV subsequent to Amendment 70, together with a summary of the principal subjects involved and the dates on which the Annex and the amendments were adopted by Council, when they became effective and when they became applicable.

Action by Contracting States

Notification of differences. The attention of Contracting States is drawn to the obligation imposed by Article 38 of the Convention by which Contracting States are required to notify the Organization of any differences between their national regulations and practices and the International Standards contained in this Annex and any amendments thereto. Contracting States are invited to extend such notification to any differences from the Recommended Practices contained in this Annex and any amendments thereto, when the notification of such differences is important for the safety of air navigation. Further, Contracting States are invited to keep the Organization currently informed of any differences which may subsequently occur, or of the withdrawal of any differences previously notified. A specific request for notification of differences will be sent to Contracting States immediately after the adoption of each amendment to this Annex.

The attention of States is also drawn to the provisions of Annex 15 related to the publication of differences between their national regulations and practices and the related ICAO Standards and Recommended Practices through the Aeronautical Information Service, in addition to the obligation of States under Article 38 of the Convention.

Promulgation of information. The establishment and withdrawal of and changes to facilities, services and procedures affecting aircraft operations provided in accordance with the Standards, Recommended Practices and Procedures specified in Annex 10 should be notified and take effect in accordance with the provisions of Annex 15.

Use of the text of the Annex in national regulations. The Council, on 13 April 1948, adopted a resolution inviting the attention of Contracting States to the desirability of using in their own national regulations, as far as practicable, the precise language of those ICAO Standards that are of a regulatory character and also of indicating departures from the Standards, including any additional national regulations that were important for the safety or regularity of air navigation. Wherever possible, the provisions of this Annex have been deliberately written in such a way as would facilitate incorporation, without major textual changes, into national legislation.

Status of Annex components

An Annex is made up of the following component parts, not all of which, however, are necessarily found in every Annex; they have the status indicated:

1.— *Material comprising the Annex proper:*

- a) *Standards and Recommended Practices adopted by the Council under the provisions of the Convention.* They are defined as follows:

Standard: Any specification for physical characteristics, configuration, matériel, performance, personnel or procedure, the uniform application of which is recognized as necessary for the safety or regularity of international air navigation and to which Contracting States will conform in accordance with the Convention; in the event of impossibility of compliance, notification to the Council is compulsory under Article 38.

Recommended Practice: Any specification for physical characteristics, configuration, matériel, performance, personnel or procedure, the uniform application of which is recognized as desirable in the interest of safety, regularity or efficiency of international air navigation, and to which Contracting States will endeavour to conform in accordance with the Convention.

- b) *Appendices* comprising material grouped separately for convenience but forming part of the Standards and Recommended Practices adopted by the Council.
- c) *Definitions* of terms used in the Standards and Recommended Practices which are not self-explanatory in that they do not have accepted dictionary meanings. A definition does not have independent status but is an essential part of each Standard and Recommended Practice in which the term is used, since a change in the meaning of the term would affect the specification.
- d) *Tables and Figures* which add to or illustrate a Standard or Recommended Practice and which are referred to therein, form part of the associated Standard or Recommended Practice and have the same status.

2.— *Material approved by the Council for publication in association with the Standards and Recommended Practices:*

- a) *Forewords* comprising historical and explanatory material based on the action of the Council and including an explanation of the obligations of States with regard to the application of the Standards and Recommended Practices ensuing from the Convention and the Resolution of Adoption;
- b) *Introductions* comprising explanatory material introduced at the beginning of parts, chapters or sections of the Annex to assist in the understanding of the application of the text;

- c) *Notes* included in the text, where appropriate, to give factual information or references bearing on the Standards or Recommended Practices in question, but not constituting part of the Standards or Recommended Practices;
- d) *Attachments* comprising material supplementary to the Standards and Recommended Practices, or included as a guide to their application.

Disclaimer regarding patents

Attention is drawn to the possibility that certain elements of Standards and Recommended Practices in this Annex may be the subject of patents or other intellectual property rights. ICAO shall not be responsible or liable for not identifying any or all such rights. ICAO takes no position regarding the existence, validity, scope or applicability of any claimed patents or other intellectual property rights, and accepts no responsibility or liability therefore or relating thereto.

Selection of language

This Annex has been adopted in four languages — English, French, Russian and Spanish. Each Contracting State is requested to select one of those texts for the purpose of national implementation and for other effects provided for in the Convention, either through direct use or through translation into its own national language, and to notify the Organization accordingly.

Editorial practices

The following practice has been adhered to in order to indicate at a glance the status of each statement: *Standards* have been printed in light face roman; *Recommended Practices* have been printed in light face italics, the status being indicated by the prefix **Recommendation**; *Notes* have been printed in light face italics, the status being indicated by the prefix Note.

The following editorial practice has been followed in the writing of specifications: for Standards the operative verb “shall” is used, and for Recommended Practices the operative verb “should” is used.

The units of measurement used in this document are in accordance with the International System of Units (SI) as specified in Annex 5 to the Convention on International Civil Aviation. Where Annex 5 permits the use of non-SI alternative units these are shown in parentheses following the basic units. Where two sets of units are quoted it must not be assumed that the pairs of values are equal and interchangeable. It may, however, be inferred that an equivalent level of safety is achieved when either set of units is used exclusively.

Any reference to a portion of this document, which is identified by a number and/or title, includes all subdivisions of that portion.

Table A. Amendments to Annex 10, Volume IV

<i>Amendment</i>	<i>Source(s)</i>	<i>Subject(s)</i>	<i>Adopted/approved Effective Applicable</i>
70	Air Navigation Commission; Fifth meeting of the Secondary Surveillance Radar Improvements and Collision Avoidance Systems Panel	Creation of Volume IV and introduction of Standards and Recommended Practices and related guidance material for the airborne collision avoidance system (ACAS).	20 March 1995 24 July 1995 9 November 1995
71	Air Navigation Commission; Fourth and fifth meetings of the Secondary Surveillance Radar Improvements and Collision Avoidance Systems Panel (SICASP)	Changes to material related to SSR Mode S air-ground data link system and the carriage of SSR transponders.	12 March 1996 15 July 1996 7 November 1996
72	—	No change.	—
73 (2nd edition)	Air Navigation Commission; Sixth meeting of the Secondary Surveillance Radar Improvements and Collision Avoidance Systems Panel (SICASP)	Addition of specifications for the SSR Mode S system; introduction of material related to the performance of the collision avoidance logic; changes to guidance material related to the airborne collision avoidance system; introduction of Human Factors related material.	19 March 1998 20 July 1998 5 November 1998
74	Air Navigation Commission	Note related to the waiving of patent rights on Mode S extended squitter technique.	18 March 1999 18 March 1999 —
75	—	No change.	—
76	Seventh meeting of the Aeronautical Mobile Communications Panel (AMCP)	Note related to update of references to the ITU Radio Regulations.	12 March 2001 12 March 2001 —
77 (3rd edition)	Seventh meeting of the Secondary Surveillance Radar Improvements and Collision Avoidance Systems Panel (SICASP)	SSR Mode S (Chapters 2 and 3); and ACAS (Chapters 1 and 4).	27 February 2002 15 July 2002 28 November 2002
78	—	No change.	—
79	—	No change.	—
80	—	No change.	—
81	—	No change.	—
82 (4th edition)	Surveillance and Conflict Resolution Systems Panel (SCRSP)	Updates to SARPs on ADS-B	26 February 2007 16 July 2007 22 November 2007
83	—	No change.	—
84	—	No change.	—

<i>Amendment</i>	<i>Source(s)</i>	<i>Subject(s)</i>	<i>Adopted/approved Effective Applicable</i>
85	Aeronautical Surveillance Panel (ASP)	<ul style="list-style-type: none"> a) Update of provisions relating to secondary surveillance radar (SSR) (Modes A/C and S) and automatic dependent surveillance — broadcast (ADS-B) using 1 090 MHz extended squitter resulting from operational experience; b) introduction of a system-level and functional requirement for multilateration systems used for air traffic surveillance; c) introduction of an initial set of technical requirements for airborne surveillance applications that are enabled by the use of ADS-B IN messages on the flight deck; d) new requirements for display of proximate traffic, traffic advisory (TA) and resolution advisory (RA); e) update of provisions on hybrid surveillance in light of relevant recent developments; and f) introduction of a new functional requirement for monitoring own aircraft's vertical rate during an RA which would be affected by implementing a new version of the collision avoidance system (CAS) logic (commonly referred to as traffic alert and collision avoidance system (TCAS) Version 7.1). The new version of the CAS logic would also include a change in the annunciation of the RA "Adjust Vertical Speed, Adjust" to "Level Off". 	26 February 2010 12 July 2010 18 November 2010
86	—	No change.	—
87	—	No change.	—
88-A	—	No change.	—
88-B	—	No change.	—
89 (5th edition)	Aeronautical Surveillance Panel (ASP)	Surveillance systems	3 March 2014 14 July 2014 13 November 2014
90	First and second meetings of the Surveillance Panel (SP/1 and SP/2)	<ul style="list-style-type: none"> a) airborne collision avoidance system (ACAS); and b) secondary surveillance radar (SSR) and wide area multilateration (WAM). 	7 March 2018 16 July 2018 8 November 2018
91	Third meeting of the Surveillance Panel (SP/3)	Newly developed airborne collision avoidance system X (ACAS X) and a provision to reduce false ACAS alerts.	7 March 2022 18 July 2022 3 November 2022

INTERNATIONAL STANDARDS AND RECOMMENDED PRACTICES

CHAPTER 1. DEFINITIONS

Note 1.— All references to “Radio Regulations” are to the Radio Regulations published by the International Telecommunication Union (ITU). Radio Regulations are amended from time to time by the decisions embodied in the Final Acts of World Radiocommunication Conferences held normally every two to three years. Further information on the ITU processes as they relate to aeronautical radio system frequency use is contained in the Handbook on Radio Frequency Spectrum Requirements for Civil Aviation including statement of approved ICAO policies (Doc 9718).

Note 2.— The Mode S extended squitter system is subject to patent rights from the Massachusetts Institute of Technology (MIT) Lincoln Laboratory. On 22 August 1996, MIT Lincoln Laboratory issued a notice in the Commerce Business Daily (CBD), a United States Government publication, of its intent not to assert its rights as patent owner against any and all persons in the commercial or non-commercial practice of the patent, in order to promote the widest possible use of the Mode S extended squitter technology. Further, by letter to ICAO dated 27 August 1998, MIT Lincoln Laboratory confirmed that the CBD notice has been provided to satisfy ICAO requirements for a statement of patent rights for techniques that are included in SARPs, and that the patent holders offer this technique free of charge for any use.

Airborne collision avoidance system (ACAS). An aircraft system based on secondary surveillance radar (SSR) transponder signals which operates independently of ground-based equipment to provide advice to the pilot on potential conflicting aircraft that are equipped with SSR transponders.

Note.— SSR transponders referred to above are those operating in Mode C or Mode S. ACAS may also use automatic dependent surveillance — broadcast (ADS-B) signals received from other aircraft to improve its performance.

Aircraft address. A unique combination of twenty-four bits available for assignment to an aircraft for the purpose of air-ground communications, navigation and surveillance.

Note.— SSR Mode S transponders transmit extended squitters to support the broadcast of aircraft-derived position for surveillance purposes. The broadcast of this type of information is a form of automatic dependent surveillance (ADS) known as ADS-broadcast (ADS-B).

Automatic dependent surveillance-broadcast (ADS-B) OUT. A function on an aircraft or vehicle that periodically broadcasts its state vector (position and velocity) and other information derived from on-board systems in a format suitable for ADS-B IN capable receivers.

Automatic dependent surveillance-broadcast (ADS-B) IN. A function that receives surveillance data from ADS-B OUT data sources.

Collision avoidance logic. The sub-system or part of ACAS that analyses data relating to an intruder and own aircraft, decides whether or not advisories are appropriate and, if so, generates the advisories. It includes the following functions: range and altitude tracking, threat detection and RA generation. It excludes surveillance.

Human Factors principles. Principles which apply to design, certification, training, operations and maintenance and which seek safe interface between the human and other system components by proper consideration to human performance.

Secondary surveillance radar (SSR). A surveillance radar system which uses transmitters/receivers (interrogators) and transponders.

Note.— *The requirements for interrogators and transponders are specified in Chapter 3.*

Surveillance radar. Radar equipment used to determine the position of an aircraft in range and azimuth.

Traffic information service – broadcast (TIS-B) IN. A surveillance function that receives and processes surveillance data from TIS-B OUT data sources.

Traffic information service – broadcast (TIS-B) OUT. A function on the ground that periodically broadcasts the surveillance information made available by ground sensors in a format suitable for TIS-B IN capable receivers.

Note.— *This technique can be achieved through different data links. The requirements for Mode S extended squitters are specified in Annex 10, Volume IV, Chapter 5. The requirements for VHF digital link (VDL) Mode 4 and universal access transceiver (UAT) are specified in Annex 10, Volume III, Part I.*

Transponder occupancy. A state of unavailability of the transponder from the time it detects an incoming signal that appears to cause some action or from the time of a self-initiated transmission, to the time that it is capable of replying to another interrogation.

Note.— *Signals from various systems that contribute to transponder occupancy are described in the Aeronautical Surveillance Manual (Doc 9924), Appendix M.*

CHAPTER 2. GENERAL

2.1 SECONDARY SURVEILLANCE RADAR (SSR)

2.1.1 When SSR is installed and maintained in operation as an aid to air traffic services, it shall conform with the provisions of 3.1 unless otherwise specified in this 2.1.

Note.— As referred to in this Annex, Mode A/C transponders are those which conform to the characteristics prescribed in 3.1.1. Mode S transponders are those which conform to the characteristics prescribed in 3.1.2. The functional capabilities of Mode A/C transponders are an integral part of those of Mode S transponders.

2.1.2 Interrogation modes (ground-to-air)

2.1.2.1 Interrogation for air traffic services shall be performed on the modes described in 3.1.1.4.3 or 3.1.2. The uses of each mode shall be as follows:

- 1) *Mode A* — to elicit transponder replies for identity and surveillance.
- 2) *Mode C* — to elicit transponder replies for automatic pressure-altitude transmission and surveillance.
- 3) *Intermode* —
 - a) *Mode A/C/S all-call*: to elicit replies for surveillance of Mode A/C transponders and for the acquisition of Mode S transponders.
 - b) *Mode A/C-only all-call*: to elicit replies for surveillance of Mode A/C transponders. Mode S transponders do not reply.
- 4) *Mode S* —
 - a) *Mode S-only all-call*: to elicit replies for acquisition of Mode S transponders.
 - b) *Broadcast*: to transmit information to all Mode S transponders. No replies are elicited.
 - c) *Selective*: for surveillance of, and communication with, individual Mode S transponders. For each interrogation, a reply is elicited only from the transponder uniquely addressed by the interrogation.

Note 1.— Mode A/C transponders are suppressed by Mode S interrogations and do not reply.

Note 2.— There are 25 possible interrogation (uplink) formats and 25 possible Mode S reply (downlink) formats. For format assignment see 3.1.2.3.2, Figures 3-7 and 3-8.

2.1.2.1.1 **Recommendation.**— *Administrations should coordinate with appropriate national and international authorities those implementation aspects of the SSR system which will permit its optimum use.*

Note.— In order to permit the efficient operation of ground equipment designed to eliminate interference from unwanted aircraft transponder replies to adjacent interrogators (defruiting equipment), States may need to develop coordinated plans for the assignment of pulse recurrence frequencies (PRF) to SSR interrogators.

2.1.2.1.2 The assignment of interrogator identifier (II) codes, where necessary in areas of overlapping coverage, across international boundaries of flight information regions, shall be the subject of regional air navigation agreements.

2.1.2.1.3 The assignment of surveillance identifier (SI) codes, where necessary in areas of overlapping coverage, shall be the subject of regional air navigation agreements.

Note.— *The SI lockout facility cannot be used unless all Mode S transponders within coverage range are equipped for this purpose.*

2.1.2.2 Mode A and Mode C interrogations shall be provided.

Note.— *This requirement may be satisfied by intermode interrogations which elicit Mode A and Mode C replies from Mode A/C transponders.*

2.1.2.3 **Recommendation.**— *In areas where improved aircraft identification is necessary to enhance the effectiveness of the ATC system, SSR ground facilities having Mode S features should include aircraft identification capability.*

Note.— *Aircraft identification reporting through the Mode S data link provides unambiguous identification of aircraft suitably equipped.*

2.1.2.4 SIDE-LOBE SUPPRESSION CONTROL INTERROGATION

2.1.2.4.1 Side-lobe suppression shall be provided in accordance with the provisions of 3.1.1.4 and 3.1.1.5 on all Mode A, Mode C and intermode interrogations.

2.1.2.4.2 Side-lobe suppression shall be provided in accordance with the provisions of 3.1.2.1.5.2.1 on all Mode S-only all-call interrogations.

2.1.3 Transponder reply modes (air-to-ground)

2.1.3.1 Transponders shall respond to Mode A interrogations in accordance with the provisions of 3.1.1.7.12.1 and to Mode C interrogations in accordance with the provisions of 3.1.1.7.12.2.

Note.— *If pressure-altitude information is not available, transponders reply to Mode C interrogations with framing pulses only.*

2.1.3.1.1 The pressure-altitude reports contained in Mode S replies shall be derived as specified in 3.1.1.7.12.2.

Note.— *3.1.1.7.12.2 is intended to relate to Mode C replies and specifies, inter alia, that Mode C pressure-altitude reports be referenced to a standard pressure setting of 1 013.25 hectopascals. The intention of 2.1.3.1.1 is to ensure that all transponders, not just Mode C transponders, report uncorrected pressure-altitude.*

2.1.3.2 Where the need for Mode C automatic pressure-altitude transmission capability within a specified airspace has been determined, transponders, when used within the airspace concerned, shall respond to Mode C interrogations with pressure-altitude encoding in the information pulses.

2.1.3.2.1 From 1 January 1999, all transponders, regardless of the airspace in which they will be used, shall respond to Mode C interrogations with pressure-altitude information.

Note.— *Operation of the airborne collision avoidance system (ACAS) depends upon intruder aircraft reporting pressure-altitude in Mode C replies.*

2.1.3.2.2 For aircraft equipped with 7.62 m (25 ft) or better pressure-altitude sources, the pressure-altitude information provided by Mode S transponders in response to selective interrogations (i.e. in the AC field, 3.1.2.6.5.4) shall be reported in 7.62 m (25 ft) increments.

Note.— Performance of the ACAS is significantly enhanced when an intruder aircraft is reporting pressure-altitude in 7.62 m (25 ft) increments.

2.1.3.2.3 All Mode A/C transponders shall report pressure-altitude encoded in the information pulses in Mode C replies.

2.1.3.2.4 All Mode S transponders shall report pressure-altitude encoded in the information pulses in Mode C replies and in the AC field of Mode S replies.

2.1.3.2.5 When a Mode S transponder is not receiving more pressure-altitude information from a source with a quantization of 7.62 m (25 ft) or better increments, the reported value of the altitude shall be the value obtained by expressing the measured value of the uncorrected pressure-altitude of the aircraft in 30.48 m (100 ft) increments and the Q bit (see 3.1.2.6.5.4 b)) shall be set to 0.

Note.— This requirement relates to the installation and use of the Mode S transponder. The purpose is to ensure that altitude data obtained from a 30.48 m (100 ft) increment source are not reported using the formats intended for 7.62 m (25 ft) data.

2.1.3.3 Transponders used within airspace where the need for Mode S airborne capability has been determined shall also respond to intermode and Mode S interrogations in accordance with the applicable provisions of 3.1.2.

2.1.3.3.1 Requirements for mandatory carriage of SSR Mode S transponders shall be on the basis of regional air navigation agreements which shall specify the airspace and the airborne implementation timescales.

2.1.3.3.2 **Recommendation.**— *The agreements indicated in 2.1.3.3.1 should provide at least five years' notice.*

2.1.4 Mode A reply codes (information pulses)

2.1.4.1 All transponders shall be capable of generating 4 096 reply codes conforming to the characteristics given in 3.1.1.6.2.

2.1.4.1.1 **Recommendation.**— *ATS authorities should establish the procedures for the allotment of SSR codes in conformity with Regional Air Navigation agreements, taking into account other users of the system.*

Note.— Principles for the allocation of SSR codes are given in Doc 4444, Chapter 8.

2.1.4.2 The following Mode A codes shall be reserved for special purposes:

2.1.4.2.1 Code 7700 to provide recognition of an aircraft in an emergency.

2.1.4.2.2 Code 7600 to provide recognition of an aircraft with radiocommunication failure.

2.1.4.2.3 Code 7500 to provide recognition of an aircraft which is being subjected to unlawful interference.

2.1.4.3 Appropriate provisions shall be made in ground decoding equipment to ensure immediate recognition of Mode A codes 7500, 7600 and 7700.

2.1.4.4 **Recommendation.**— *Mode A code 0000 should be reserved for allocation subject to regional agreement, as a general purpose code.*

2.1.4.5 Mode A code 2000 shall be reserved to provide recognition of an aircraft which has not received any instructions from air traffic control units to operate the transponder.

2.1.5 Mode S airborne equipment capability

2.1.5.1 All Mode S transponders shall conform to one of the following five levels:

Note.— *The transponder used for a Mode S site monitor may differ from the requirements defined for a normal Mode S transponder. For example, it may be necessary to reply to all-call interrogations when on the ground. For more details see the Aeronautical Surveillance Manual (Doc 9924) Appendix D.*

2.1.5.1.1 Level 1 — Level 1 transponders shall have the capabilities prescribed for:

- a) Mode A identity and Mode C pressure-altitude reporting (3.1.1);
- b) intermode and Mode S all-call transactions (3.1.2.5);
- c) addressed surveillance altitude and identity transaction (3.1.2.6.1, 3.1.2.6.3, 3.1.2.6.5 and 3.1.2.6.7);
- d) lockout protocols (3.1.2.6.9);
- e) basic data protocols except data link capability reporting (3.1.2.6.10); and
- f) air-air service and squitter transactions (3.1.2.8).

Note.— *Level 1 permits SSR surveillance based on pressure-altitude reporting and the Mode A identity code. In an SSR Mode S environment, technical performance relative to a Mode A/C transponder is improved due to Mode S selective aircraft interrogation.*

2.1.5.1.2 Level 2 — Level 2 transponders shall have the capabilities of 2.1.5.1.1 and also those prescribed for:

- a) standard length communications (Comm-A and Comm-B) (3.1.2.6.2, 3.1.2.6.4, 3.1.2.6.6, 3.1.2.6.8 and 3.1.2.6.11);
- b) data link capability reporting (3.1.2.6.10.2.2);
- c) aircraft identification reporting (3.1.2.9); and
- d) data parity with overlay control (3.1.2.6.11.2.5) for equipment certified on or after 1 January 2020.

Note.— *Level 2 permits aircraft identification reporting and other standard length data link communications from ground to air and air to ground. The aircraft identification reporting capability requires an interface and appropriate input device.*

2.1.5.1.3 Level 3 — Level 3 transponders shall have the capabilities of 2.1.5.1.2 and also those prescribed for ground-to-air extended length message (ELM) communications (3.1.2.7.1 to 3.1.2.7.5).

Note.— *Level 3 permits extended length data link communications from ground to air and thus may provide retrieval from ground-based data banks and receipt of other air traffic services which are not available with Level 2 transponders.*

2.1.5.1.4 Level 4 — Level 4 transponders shall have the capabilities of 2.1.5.1.3 and also those prescribed for air-to-ground extended length message (ELM) communications (3.1.2.7.7 and 3.1.2.7.8).

Note.— Level 4 permits extended length data link communications from air to ground and thus may provide access from the ground to airborne data sources and the transmission of other data required by air traffic services which are not available with Level 2 transponders.

2.1.5.1.5 Level 5 — Level 5 transponders shall have the capabilities of 2.1.5.1.4 and also those prescribed for enhanced Comm-B and extended length message (ELM) communications (3.1.2.6.11.3.4, 3.1.2.7.6 and 3.1.2.7.9).

Note.— Level 5 permits Comm-B and extended length data link communications with multiple interrogators without requiring the use of multisite reservations. This level of transponder has a higher minimum data link capacity than the other transponder levels.

2.1.5.1.6 *Extended squitter* — Extended squitter transponders shall have the capabilities of 2.1.5.1.2, 2.1.5.1.3, 2.1.5.1.4 or 2.1.5.1.5, the capabilities prescribed for extended squitter operation (3.1.2.8.6) and the capabilities prescribed for ACAS cross-link operation (3.1.2.8.3 and 3.1.2.8.4). Transponders with these capabilities shall be designated with a suffix “e”.

Note.— For example, a level 4 transponder with extended squitter capability would be designated “level 4e”.

2.1.5.1.7 *SI capability* — Transponders with the ability to process SI codes shall have the capabilities of 2.1.5.1.1, 2.1.5.1.2, 2.1.5.1.3, 2.1.5.1.4 or 2.1.5.1.5 and also those prescribed for SI code operation (3.1.2.3.2.1.4, 3.1.2.5.2.1, 3.1.2.6.1.3, 3.1.2.6.1.4.1, 3.1.2.6.9.1.1 and 3.1.2.6.9.2). Transponders with this capability shall be designated with a suffix “s”.

Note.— For example, a level 4 transponder with extended squitter capability and SI capability would be designated “level 4es”.

2.1.5.1.7.1 SI code capability shall be provided in accordance with the provisions of 2.1.5.1.7 for all Mode S transponders installed on or after 1 January 2003 and by all Mode S transponders by 1 January 2005.

Note.— Mandates from certain States may require applicability in advance of these dates.

2.1.5.1.8 *Extended squitter non-transponder devices.* Devices that are capable of broadcasting extended squitters that are not part of a Mode S transponder shall conform to all of the 1 090 MHz RF signals in space requirements specified for a Mode S transponder, except for transmit power levels for the identified equipment class as specified in 5.1.1.

2.1.5.2 All Mode S transponders used by international civil air traffic shall conform, at least, to the requirements of Level 2 prescribed in 2.1.5.1.2.

Note 1.— Level 1 may be admitted for use within an individual State or within the terms of a regional air navigation agreement. The Mode S Level 1 transponder comprises the minimum set of features for compatible operation of Mode S transponders with SSR Mode S interrogators. It is defined to prevent a proliferation of transponder types below Level 2 which would be incompatible with SSR Mode S interrogators.

Note 2.— The intent of the requirement for a Level 2 capability is to ensure the widespread use of an ICAO standard transponder capability to allow worldwide planning of Mode S ground facilities and services. The requirement also discourages an initial installation with Level 1 transponders that would be rendered obsolete by later requirements in certain airspace for mandatory carriage of transponders having Level 2 capabilities.

2.1.5.3 Mode S transponders installed on aircraft with gross mass in excess of 5 700 kg or a maximum cruising true airspeed capability in excess of 463 km/h (250 kt) shall operate with antenna diversity as prescribed in 3.1.2.10.4 if:

- a) the aircraft individual certificate of airworthiness is first issued on or after 1 January 1990; or

- b) Mode S transponder carriage is required on the basis of regional air navigation agreement in accordance with 2.1.3.3.1 and 2.1.3.3.2.

Note.— Aircraft with maximum cruising true airspeed exceeding 324 km/h (175 kt) are required to operate with a peak power of not less than 21.0 dBW as specified in 3.1.2.10.2 c).

2.1.5.4 CAPABILITY REPORTING IN MODE S SQUITTERS

2.1.5.4.1 Capability reporting in Mode S acquisition squitters (unsolicited downlink transmissions) shall be provided in accordance with the provisions of 3.1.2.8.5.1 for all Mode S transponders installed on or after 1 January 1995.

2.1.5.4.2 **Recommendation.**— Transponders equipped for extended squitter operation should have a means to disable acquisition squitters when extended squitters are being emitted.

Note.— This will facilitate the suppression of acquisition squitters if all ACAS units have been converted to receive the extended squitter.

2.1.5.5 EXTENDED LENGTH MESSAGE (ELM) TRANSMIT POWER

In order to facilitate the conversion of existing Mode S transponders to include full Mode S capability, transponders originally manufactured before 1 January 1999 shall be permitted to transmit a burst of 16 ELM segments at a minimum power level of 20 dBW.

Note.— This represents a 1 dB relaxation from the power requirement specified in 3.1.2.10.2.

2.1.6 SSR Mode S address (aircraft address)

The SSR Mode S address shall be one of 16 777 214 twenty-four-bit aircraft addresses allocated by ICAO to the State of Registry or common mark registering authority and assigned as prescribed in 3.1.2.4.1.2.3.1.1 and the Appendix to Chapter 9, Part I, Volume III, Annex 10.

2.1.7 Transponder occupancy

Note.— See Appendix M of the Aeronautical Surveillance Manual (Doc 9924) for guidance on consistent modelling of transponder occupancy.

2.2 HUMAN FACTORS CONSIDERATIONS

Recommendation.— Human Factors principles should be observed in the design and certification of surveillance radar, transponder and collision avoidance systems.

Note.— Guidance material on Human Factors principles can be found in Doc 9683, Human Factors Training Manual and Circular 249 (Human Factors Digest No. 11 — Human Factors in CNS/ATM Systems).

2.2.1 Operation of controls

2.2.1.1 Transponder controls which are not intended to be operated in flight shall not be directly accessible to the flight crew.

2.2.1.2 **Recommendation.**— *The operation of transponder controls, intended for use during flight, should be evaluated to ensure they are logical and tolerant to human error. In particular, where transponder functions are integrated with other system controls, the manufacturer should ensure that unintentional transponder mode switching (i.e. an operational state to 'STANDBY' or 'OFF') is minimized.*

Note.— *This may take the form of a confirmation of mode switching, required by the flight crew. Typically 'Line Select' Keys, 'Touch Screen' or 'Cursor Controlled/Tracker-ball' methods used to change transponder modes should be carefully designed to minimize flight crew error.*

2.2.1.3 **Recommendation.**— *The flight crew should have access at all times to the information of the operational state of the transponder.*

Note.— *Information on the monitoring of the operational state of the transponder is provided in RTCA DO-181 E, Minimum Operational Performance Standards for Air Traffic Control Radar Beacon System/ Mode Select (ATCRBS/Mode S) Airborne Equipment, and in EUROCAE ED-73E, Minimum Operational Performance Specification for Secondary Surveillance Radar Mode S Transponders.*

CHAPTER 3. SURVEILLANCE SYSTEMS

3.1 SECONDARY SURVEILLANCE RADAR (SSR) SYSTEM CHARACTERISTICS

Note 1.— Section 3.1.1 prescribes the technical characteristics of SSR systems having only Mode A and Mode C capabilities. Section 3.1.2 prescribes the characteristics of systems with Mode S capabilities. Chapter 5 prescribes additional requirements on Mode S extended squitters.

Note 2.— Systems using Mode S capabilities are generally used for air traffic control surveillance systems. In addition, certain ATC applications may use Mode S emitters, e.g. for vehicle surface surveillance or for fixed target detection on surveillance systems. Under such specific conditions, the term “aircraft” can be understood as “aircraft or vehicle (A/V)”. While those applications may use a limited set of data, any deviation from standard physical characteristics must be considered very carefully by the appropriate authorities. They must take into account not only their own surveillance (SSR) environment but also possible effects on other systems like ACAS.

Note 3.— Non-Standard-International alternative units are used as permitted by Annex 5, Chapter 3, 3.2.2.

3.1.1 Systems having only Mode A and Mode C capabilities

Note 1.— In this section, SSR modes are designated by letters A and C. Suffix letters, e.g. A₂, C₄, are used to designate the individual pulses used in the air-to-ground pulse trains. This common use of letters is not to be construed as implying any particular association of modes and codes.

Note 2.— Provisions for the recording and retention of radar data are contained in Annex 11, Chapter 6.

3.1.1.1 INTERROGATION AND CONTROL (INTERROGATION SIDE-LOBE SUPPRESSION) RADIO FREQUENCIES (GROUND-TO-AIR)

3.1.1.1.1 The carrier frequency of the interrogation and control transmissions shall be 1 030 MHz.

3.1.1.1.2 The frequency tolerance shall be plus or minus 0.2 MHz.

3.1.1.1.3 The carrier frequencies of the control transmission and of each of the interrogation pulse transmissions shall not differ from each other by more than 0.2 MHz.

3.1.1.2 REPLY CARRIER FREQUENCY (AIR-TO-GROUND)

3.1.1.2.1 The carrier frequency of the reply transmission shall be 1 090 MHz.

3.1.1.2.2 The frequency tolerance shall be plus or minus 3 MHz.

3.1.1.3 POLARIZATION

Polarization of the interrogation, control and reply transmissions shall be predominantly vertical.

3.1.1.4 INTERROGATION MODES (SIGNALS-IN-SPACE)

3.1.1.4.1 The interrogation shall consist of two transmitted pulses designated P_1 and P_3 . A control pulse P_2 shall be transmitted following the first interrogation pulse P_1 .

3.1.1.4.2 Interrogation Modes A and C shall be as defined in 3.1.1.4.3.

3.1.1.4.3 The interval between P_1 and P_3 shall determine the mode of interrogation and shall be as follows:

Mode A 8 ± 0.2 microseconds

Mode C 21 ± 0.2 microseconds

3.1.1.4.4 The interval between P_1 and P_2 shall be 2.0 plus or minus 0.15 microseconds.

3.1.1.4.5 The duration of pulses P_1 , P_2 and P_3 shall be 0.8 plus or minus 0.1 microsecond.

3.1.1.4.6 The rise time of pulses P_1 , P_2 and P_3 shall be between 0.05 and 0.1 microsecond.

Note 1.— The definitions are contained in Figure 3-1 “Definitions of secondary surveillance radar waveform shapes, intervals and the reference point for sensitivity and power”.

Note 2.— The intent of the lower limit of rise time (0.05 microsecond) is to reduce sideband radiation. Equipment will meet this requirement if the sideband radiation is no greater than that which, theoretically, would be produced by a trapezoidal wave having the stated rise time.

3.1.1.4.7 The decay time of pulses P_1 , P_2 and P_3 shall be between 0.05 and 0.2 microsecond.

Note.— The intent of the lower limit of decay time (0.05 microsecond) is to reduce sideband radiation. Equipment will meet this requirement if the sideband radiation is no greater than that which, theoretically, would be produced by a trapezoidal wave having the stated decay time.

3.1.1.5 INTERROGATOR AND CONTROL TRANSMISSION CHARACTERISTICS
(INTERROGATION SIDE-LOBE SUPPRESSION — SIGNALS-IN-SPACE)

3.1.1.5.1 The radiated amplitude of P_2 at the antenna of the transponder shall be:

- a) equal to or greater than the radiated amplitude of P_1 from the side-lobe transmissions of the antenna radiating P_1 ;
and
- b) at a level lower than 9 dB below the radiated amplitude of P_1 , within the desired arc of interrogation.

3.1.1.5.2 Within the desired beam width of the directional interrogation (main lobe), the radiated amplitude of P_3 shall be within 1 dB of the radiated amplitude of P_1 .

3.1.1.6 REPLY TRANSMISSION CHARACTERISTICS (SIGNALS-IN-SPACE)

3.1.1.6.1 *Framing pulses.* The reply function shall employ a signal comprising two framing pulses spaced 20.3 microseconds as the most elementary code.

3.1.1.6.2 *INFORMATION PULSES*

3.1.1.6.2.1 Information pulses shall be spaced in increments of 1.45 microseconds from the first framing pulse. The designation and position of these information pulses shall be as follows:

<i>Pulses</i>	<i>Position (microseconds)</i>
C ₁	1.45
A ₁	2.90
C ₂	4.35
A ₂	5.80
C ₄	7.25
A ₄	8.70
X	10.15
B ₁	11.60
D ₁	13.05
B ₂	14.50
D ₂	15.95
B ₄	17.40
D ₄	18.85

Note.— The Standard relating to the use of these pulses is given in 2.1.4.1. Information on the “X” pulse is contained in the Aeronautical Surveillance Manual (Doc 9924).

3.1.1.6.2.2 The position of the X pulse shall not be used in replies to Mode A or Mode C interrogations if the safe operation of surveillance systems cannot be maintained.

3.1.1.6.2.3 **Recommendation.**— *Utilization of the X pulse for special applications should be carried out in conformance with a procedure established by the State to ensure compatibility of all systems.*

3.1.1.6.3 *Special position identification pulse (SPI).* In addition to the information pulses provided, a special position identification pulse shall be transmitted but only as a result of manual (pilot) selection. When transmitted, it shall be spaced at an interval of 4.35 microseconds following the last framing pulse of Mode A replies only.

3.1.1.6.4 *Reply pulse shape.* All reply pulses shall have a pulse duration of 0.45 plus or minus 0.1 microsecond, a pulse rise time between 0.05 and 0.1 microsecond and a pulse decay time between 0.05 and 0.2 microsecond. The pulse amplitude variation of one pulse with respect to any other pulse in a reply train shall not exceed 1 dB.

Note.— *The intent of the lower limit of rise and decay times (0.05 microsecond) is to reduce sideband radiation. Equipment will meet this requirement if the sideband radiation is not greater than that which, theoretically, would be produced by a trapezoidal wave having the stated rise and decay times.*

3.1.1.6.5 *Reply pulse position tolerances.* The pulse spacing tolerance for each pulse (including the last framing pulse) with respect to the first framing pulse of the reply group shall be plus or minus 0.10 microsecond. The pulse interval tolerance of the special position identification pulse with respect to the last framing pulse of the reply group shall be plus or minus 0.10 microsecond. The pulse spacing tolerance of any pulse in the reply group with respect to any other pulse (except the first framing pulse) shall not exceed plus or minus 0.15 microsecond.

3.1.1.6.6 *Code nomenclature.* The code designation shall consist of digits between 0 and 7 inclusive, and shall consist of the sum of the subscripts of the pulse numbers given in 3.1.1.6.2 above, employed as follows:

<i>Digit</i>	<i>Pulse Group</i>
First (most significant)	A
Second	B
Third	C
Fourth	D

3.1.1.7 TECHNICAL CHARACTERISTICS OF TRANSPONDERS WITH MODE A AND MODE C CAPABILITIES ONLY

3.1.1.7.1 *Reply.* The transponder shall reply (not less than 90 per cent triggering) when all of the following conditions have been met:

- the received amplitude of P_3 is in excess of a level 1 dB below the received amplitude of P_1 but no greater than 3 dB above the received amplitude of P_1 ;
- either no pulse is received in the interval 1.3 microseconds to 2.7 microseconds after P_1 , or P_1 exceeds by more than 9 dB any pulse received in this interval;
- the received amplitude of a proper interrogation is more than 10 dB above the received amplitude of random pulses where the latter are not recognized by the transponder as P_1 , P_2 or P_3 .

3.1.1.7.2 The transponder shall not reply under the following conditions:

- to interrogations when the interval between pulses P_1 and P_3 differs from those specified in 3.1.1.4.3 by more than plus or minus 1.0 microsecond;
- upon receipt of any single pulse which has no amplitude variations approximating a normal interrogation condition.

3.1.1.7.3 *Dead time.* After recognition of a proper interrogation, the transponder shall not reply to any other interrogation, at least for the duration of the reply pulse train. This dead time shall end no later than 125 microseconds after the transmission of the last reply pulse of the group.

3.1.1.7.4 SUPPRESSION

Note.— This characteristic is used to prevent replies to interrogations received via the side lobes of the interrogator antenna, and to prevent Mode A/C transponders from replying to Mode S interrogations.

3.1.1.7.4.1 The transponder shall be suppressed when the received amplitude of P_2 is equal to, or in excess of, the received amplitude of P_1 and spaced 2.0 plus or minus 0.15 microseconds. The detection of P_3 is not required as a prerequisite for initiation of suppression action.

3.1.1.7.4.2 The transponder suppression shall be for a period of 35 plus or minus 10 microseconds.

3.1.1.7.4.2.1 The suppression shall be capable of being reinitiated for the full duration within 2 microseconds after the end of any suppression period.

3.1.1.7.4.3 *Suppression in presence of S_1 pulse*

Note.— The S_1 pulse is used in a technique employed by ACAS known as “whisper-shout” to facilitate ACAS surveillance of Mode A/C aircraft in higher traffic densities. The whisper-shout technique is explained in the Airborne Collision Avoidance System (ACAS) Manual (Doc 9863).

When an S_1 pulse is detected 2.0 plus or minus 0.15 microseconds before the P_1 of a Mode A or Mode C interrogation:

- a) with S_1 and P_1 above MTL, the transponder shall be suppressed as specified in 3.1.1.7.4.1;
- b) with P_1 at MTL and S_1 at MTL, the transponder shall be suppressed and shall reply to no more than 10 per cent of Mode A/C interrogations;
- c) with P_1 at MTL and S_1 at MTL -3 dB, the transponder shall reply to Mode A/C interrogations at least 70 per cent of the time; and
- d) with P_1 at MTL and S_1 at MTL -6 dB, the transponder shall reply to Mode A/C interrogations at least 90 per cent of the time.

Note 1.— The suppression action is because of the detection of S_1 and P_1 and does not require detection of a P_2 or P_3 pulse.

Note 2.— S_1 has a lower amplitude than P_1 . Certain ACAS use this mechanism to improve target detection (4.3.7.1).

Note 3.— These requirements also apply to a Mode A/C only capable transponder when an S_1 precedes an intermode interrogation (2.1.2.1).

3.1.1.7.5 *RECEIVER SENSITIVITY AND DYNAMIC RANGE*

3.1.1.7.5.1 The minimum triggering level of the transponder shall be such that replies are generated to at least 90 per cent of the interrogation signals when:

- a) the two pulses P_1 and P_3 constituting an interrogation are of equal amplitude and P_2 is not detected; and
- b) the amplitude of these signals is nominally 71 dB below 1 mW, with limits between 69 dB and 77 dB below 1 mW.

3.1.1.7.5.2 The reply and suppression characteristics shall apply over a received amplitude of P_1 between minimum triggering level and 50 dB above that level.

3.1.1.7.5.3 The variation of the minimum triggering level between modes shall not exceed 1 dB for nominal pulse spacings and pulse widths.

3.1.1.7.6 *Pulse duration discrimination.* Signals of received amplitude between minimum triggering level and 6 dB above this level, and of a duration less than 0.3 microsecond, shall not cause the transponder to initiate reply or suppression action. With the exception of single pulses with amplitude variations approximating an interrogation, any single pulse of a duration more than 1.5 microseconds shall not cause the transponder to initiate reply or suppression action over the signal amplitude range of minimum triggering level (MTL) to 50 dB above that level.

3.1.1.7.7 *Echo suppression and recovery.* The transponder shall contain an echo suppression facility designed to permit normal operation in the presence of echoes of signals-in-space. The provision of this facility shall be compatible with the requirements for suppression of side lobes given in 3.1.1.7.4.1.

3.1.1.7.7.1 *Desensitization.* Upon receipt of any pulse more than 0.7 microsecond in duration, the receiver shall be desensitized by an amount that is within at least 9 dB of the amplitude of the desensitizing pulse but shall at no time exceed the amplitude of the desensitizing pulse, with the exception of possible overshoot during the first microsecond following the desensitizing pulse.

Note.— Single pulses of duration less than 0.7 microsecond are not required to cause the specified desensitization nor to cause desensitization of duration greater than permitted by 3.1.1.7.7.1 and 3.1.1.7.7.2.

3.1.1.7.7.2 *Recovery.* Following desensitization, the receiver shall recover sensitivity (within 3 dB of minimum triggering level) within 15 microseconds after reception of a desensitizing pulse having a signal strength up to 50 dB above minimum triggering level. Recovery shall be at an average rate not exceeding 4.0 dB per microsecond.

3.1.1.7.8 *Random triggering rate.* In the absence of valid interrogation signals, Mode A/C transponders shall not generate more than 30 unwanted Mode A or Mode C replies per second as integrated over an interval equivalent to at least 300 random triggers, or 30 seconds, whichever is less. This random triggering rate shall not be exceeded when all possible interfering equipments installed in the same aircraft are operating at maximum interference levels.

3.1.1.7.8.1 *Random triggering rate in the presence of low-level in-band continuous wave (CW) interference.* The total random trigger rate on all Mode A and/or Mode C replies shall not be greater than 10 reply pulse groups or suppressions per second, averaged over a period of 30 seconds, when operated in the presence of non-coherent CW interference at a frequency of $1\ 030 \pm 0.2$ MHz and a signal level of -60 dBm or less.

3.1.1.7.9 *REPLY RATE*

3.1.1.7.9.1 All transponders shall be capable of continuously generating at least 500 replies per second for a 15-pulse coded reply. Transponder installations used solely below 4 500 m (15 000 ft), or below a lesser altitude established by the appropriate authority or by regional air navigation agreement, and in aircraft with a maximum cruising true airspeed not exceeding 175 kt (324 km/h) shall be capable of generating at least 1 000 15-pulse coded replies per second for a duration of 100 milliseconds. Transponder installations operated above 4 500 m (15 000 ft) or in aircraft with a maximum cruising true airspeed in excess of 175 kt (324 km/h), shall be capable of generating at least 1 200 15-pulse coded replies per second for a duration of 100 milliseconds.

Note 1.— A 15-pulse reply includes 2 framing pulses, 12 information pulses, and the SPI pulse.

Note 2.— The reply rate requirement of 500 replies per second establishes the minimum continuous reply rate capability of the transponder. As per the altitude and speed criteria above, the 100 or 120 replies in a 100-millisecond interval defines the peak capability of the transponder. The transponder must be capable of replying to this short-term burst rate, even though the transponder may not be capable of sustaining this rate. If the transponder is subjected to interrogation rates beyond its reply rate capability, the reply rate limit control of 3.1.1.7.9.2 acts to gracefully desensitize the transponder in a manner that favours closer interrogators. Desensitization eliminates weaker interrogation signals.

3.1.1.7.9.2 *Reply rate limit control.* To protect the system from the effects of transponder over-interrogation by preventing response to weaker signals when a predetermined reply rate has been reached, a sensitivity reduction type reply limit control shall be incorporated in the equipment. The range of this control shall permit adjustment, as a minimum, to any value between 500 and 2 000 replies per second, or to the maximum reply rate capability if less than 2 000 replies per second, without regard to the number of pulses in each reply. Sensitivity reduction in excess of 3 dB shall not take effect until 90 per cent of the selected value is exceeded. Sensitivity reduction shall be at least 30 dB for rates in excess of 150 per cent of the selected value.

3.1.1.7.10 *Reply delay and jitter.* The time delay between the arrival, at the transponder receiver, of the leading edge of P_3 and the transmission of the leading edge of the first pulse of the reply shall be 3 plus or minus 0.5 microseconds. The total jitter of the reply pulse code group, with respect to P_3 , shall not exceed 0.1 microsecond for receiver input levels between

3 dB and 50 dB above minimum triggering level. Delay variations between modes on which the transponder is capable of replying shall not exceed 0.2 microsecond.

3.1.1.7.11 *TRANSPONDER POWER OUTPUT AND DUTY CYCLE*

3.1.1.7.11.1 The peak pulse power available at the antenna end of the transmission line of the transponder shall be at least 21 dB and not more than 27 dB above 1 W, except that for transponder installations used solely below 4 500 m (15 000 ft), or below a lesser altitude established by the appropriate authority or by regional air navigation agreement, a peak pulse power available at the antenna end of the transmission line of the transponder of at least 18.5 dB and not more than 27 dB above 1 W shall be permitted.

Note.— *An extended squitter non-transponder device on an aerodrome surface vehicle may operate with a lower minimum power output as specified in 5.1.1.2.*

3.1.1.7.11.2 **Recommendation.**— *The peak pulse power specified in 3.1.1.7.11.1 should be maintained over a range of replies from code 0000 at a rate of 400 replies per second to a maximum pulse content at a rate of 1 200 replies per second or a maximum value below 1 200 replies per second of which the transponder is capable.*

3.1.1.7.12 *REPLY CODES*

3.1.1.7.12.1 *Identification.* The reply to a Mode A interrogation shall consist of the two framing pulses specified in 3.1.1.6.1 together with the information pulses (Mode A code) specified in 3.1.1.6.2.

Note.— *The Mode A code designation is a sequence of four digits in accordance with 3.1.1.6.6.*

3.1.1.7.12.1.1 The Mode A code shall be manually selected from the 4 096 codes available.

3.1.1.7.12.2 *Pressure-altitude transmission.* The reply to Mode C interrogation shall consist of the two framing pulses specified in 3.1.1.6.1 above. When digitized pressure-altitude information is available, the information pulses specified in 3.1.1.6.2 shall also be transmitted.

3.1.1.7.12.2.1 Transponders shall be provided with means to remove the information pulses but to retain the framing pulses when the provision of 3.1.1.7.12.2.4 below is not complied with in reply to Mode C interrogation.

3.1.1.7.12.2.2 The information pulses shall be automatically selected by an analog-to-digital converter connected to a pressure-altitude data source in the aircraft referenced to the standard pressure setting of 1 013.25 hectopascals.

Note.— *The pressure setting of 1 013.25 hectopascals is equal to 29.92 inches of mercury.*

3.1.1.7.12.2.3 Pressure-altitude shall be reported in 100-ft increments by selection of pulses as shown in the Appendix to this chapter.

3.1.1.7.12.2.4 The digitizer code selected shall correspond to within plus or minus 38.1 m (125 ft), on a 95 per cent probability basis, with the pressure-altitude information (referenced to the standard pressure setting of 1 013.25 hectopascals), used on board the aircraft to adhere to the assigned flight profile.

3.1.1.7.13 *Transmission of the special position identification (SPI) pulse.* When required, this pulse shall be transmitted with Mode A replies, as specified in 3.1.1.6.3, for a period of between 15 and 30 seconds.

3.1.1.7.14 ANTENNA

3.1.1.7.14.1 The transponder antenna system, when installed on an aircraft, shall have a radiation pattern which is essentially omnidirectional in the horizontal plane.

3.1.1.7.14.2 **Recommendation.**— *The vertical radiation pattern should be nominally equivalent to that of a quarter-wave monopole on a ground plane.*

3.1.1.8 TECHNICAL CHARACTERISTICS OF GROUND INTERROGATORS WITH
MODE A AND MODE C CAPABILITIES ONLY

3.1.1.8.1 *Interrogation repetition frequency.* The maximum interrogation repetition frequency shall be 450 interrogations per second.

3.1.1.8.1.1 **Recommendation.**— *To minimize unnecessary transponder triggering and the resulting high density of mutual interference, all interrogators should use the lowest practicable interrogator repetition frequency that is consistent with the display characteristics, interrogator antenna beam width and antenna rotation speed employed.*

3.1.1.8.2 RADIATED POWER

Recommendation.— *In order to minimize system interference the effective radiated power of interrogators should be reduced to the lowest value consistent with the operationally required range of each individual interrogator site.*

3.1.1.8.3 **Recommendation.**— *When Mode C information is to be used from aircraft flying below transition levels, the altimeter pressure reference datum should be taken into account.*

Note.— *Use of Mode C below transition levels is in accordance with the philosophy that Mode C can usefully be employed in all environments.*

3.1.1.9 INTERROGATOR RADIATED FIELD PATTERN

Recommendation.— *The beam width of the directional interrogator antenna radiating P_3 should not be wider than is operationally required. The side- and back-lobe radiation of the directional antenna should be at least 24 dB below the peak of the main-lobe radiation.*

3.1.1.10 INTERROGATOR MONITOR

3.1.1.10.1 The range and azimuth accuracy of the ground interrogator shall be monitored at sufficiently frequent intervals to ensure system integrity.

Note.— *Interrogators that are associated with and operated in conjunction with primary radar may use the primary radar as the monitoring device; alternatively, an electronic range and azimuth accuracy monitor would be required.*

3.1.1.10.2 **Recommendation.**— *In addition to range and azimuth monitoring, provision should be made to monitor continuously the other critical parameters of the ground interrogator for any degradation of performance exceeding the allowable system tolerances and to provide an indication of any such occurrence.*

3.1.1.11 SPURIOUS EMISSIONS AND SPURIOUS RESPONSES

3.1.1.11.1 SPURIOUS RADIATION

Recommendation.— *CW radiation should not exceed 76 dB below 1 W for the interrogator and 70 dB below 1 W for the transponder.*

3.1.1.11.2 SPURIOUS RESPONSES

Recommendation.— *The response of both airborne and ground equipment to signals not within the receiver pass band should be at least 60 dB below normal sensitivity.*

3.1.2 Systems having Mode S capabilities

3.1.2.1 *Interrogation signals-in-space characteristics.* The paragraphs herein describe the signals-in-space as they can be expected to appear at the antenna of the transponder.

Note.— *Because signals can be corrupted in propagation, certain interrogation pulse duration, pulse spacing and pulse amplitude tolerances are more stringent for interrogators as described in 3.1.2.11.4.*

3.1.2.1.1 *Interrogation carrier frequency.* The carrier frequency of all interrogations (uplink transmissions) from ground facilities with Mode S capabilities shall be 1 030 plus or minus 0.01 MHz, except during the phase reversal, while maintaining the spectrum requirements of 3.1.2.1.2.

Note.— *During the phase reversal the frequency of the signal may shift by several MHz before returning to the specified value.*

3.1.2.1.2 *Interrogation spectrum.* The spectrum of a Mode S interrogation about the carrier frequency shall not exceed the limits specified in Figure 3-2.

Note.— *The Mode S interrogation spectrum is data dependent. The broadest spectrum is generated by an interrogation that contains all binary ONES.*

3.1.2.1.3 *Polarization.* Polarization of the interrogation and control transmissions shall be nominally vertical.

3.1.2.1.4 *Modulation.* For Mode S interrogations, the carrier frequency shall be pulse modulated. In addition, the data pulse, P_6 , shall have internal phase modulation.

3.1.2.1.4.1 *Pulse modulation.* Intermode and Mode S interrogations shall consist of a sequence of pulses as specified in 3.1.2.1.5 and Tables 3-1, 3-2, 3-3, and 3-4.

Note.— *The 0.8 microsecond pulses used in intermode and Mode S interrogations are identical in shape to those used in Modes A and C as defined in 3.1.1.4.*

3.1.2.1.4.2 *Phase modulation.* The short (16.25-microsecond) and long (30.25-microsecond) P_6 pulses of 3.1.2.1.4.1 shall have internal binary differential phase modulation consisting of 180-degree phase reversals of the carrier at a 4 megabit per second rate.

3.1.2.1.4.2.1 *Phase reversal duration.* The duration of the phase reversal shall be less than 0.08 microsecond and the phase shall advance (or retard) monotonically throughout the transition region. There shall be no amplitude modulation applied during the phase transition.

Note 1.— The minimum duration of the phase reversal is not specified. Nonetheless, the spectrum requirements of 3.1.2.1.2 must be met.

Note 2.— The phase reversal can be generated using different methods. This includes hard keying with strong amplitude drop and rapid phase reversal or other techniques with little or no amplitude drop, but with frequency shift during the phase reversal and slow phase reversal (80ns). A demodulator cannot make any assumption on the type of modulation technology used and therefore cannot rely on the specificities of the signal during the phase reversal to detect a phase reversal.

3.1.2.1.4.2.2 *Phase relationship.* The tolerance on the 0 and 180-degree phase relationship between successive chips and on the sync phase reversal (3.1.2.1.5.2.2) within the P_6 pulse shall be plus or minus 5 degrees.

Note.— In Mode S a “chip” is the 0.25 microsecond carrier interval between possible data phase reversals.

3.1.2.1.5 *Pulse and phase reversal sequences.* Specific sequences of the pulses or phase reversals described in 3.1.2.1.4 shall constitute interrogations.

3.1.2.1.5.1 *Intermode interrogation*

3.1.2.1.5.1.1 *Mode A/C/S all-call interrogation.* This interrogation shall consist of three pulses: P_1 , P_3 , and the long P_4 as shown in Figure 3-3. One or two control pulses (P_2 alone, or P_1 and P_2) shall be transmitted using a separate antenna pattern to suppress responses from aircraft in the side lobes of the interrogator antenna.

Note.— The Mode A/C/S all-call interrogation elicits a Mode A or Mode C reply (depending on the P_1 - P_3 pulse spacing) from a Mode A/C transponder because it does not recognize the P_4 pulse. A Mode S transponder recognizes the long P_4 pulse and responds with a Mode S reply. This interrogation was originally planned for use by isolated or clustered interrogators. Lockout for this interrogation was based on the use of II equals 0. The development of the Mode S subnetwork now dictates the use of a non-zero II code for communication purposes. For this reason, II equals 0 has been reserved for use in support of a form of Mode S acquisition that uses stochastic/lockout override (3.1.2.5.2.1.4 and 3.1.2.5.2.1.5). The Mode A/C/S all-call cannot be used with full Mode S operation since II equals 0 can only be locked out for short time periods (3.1.2.5.2.1.5.2.1). This interrogation cannot be used with stochastic/lockout override, since probability of reply cannot be specified.

3.1.2.1.5.1.1.1 Mode A/C/S all-call interrogations shall not be used on or after 1 January 2020.

Note 1.— The use of Mode A/C/S all-call interrogations does not allow the use of stochastic lockout override and therefore might not ensure a good probability of acquisition in areas of high density of flights or when other interrogators lockout transponder on $II=0$ for supplementary acquisition.

Note 2.— The replies to Mode A/C/S all-call interrogations will no longer be supported by equipment certified on or after 1 January 2020 in order to reduce the RF pollution generated by the replies triggered by the false detection of Mode A/C/S all-call interrogations within other types of interrogation.

3.1.2.1.5.1.2 *Mode A/C-only all-call interrogation.* This interrogation shall be identical to that of the Mode A/C/S all-call interrogation except that the short P_4 pulse shall be used.

Note.— The Mode A/C-only all-call interrogation elicits a Mode A or Mode C reply from a Mode A/C transponder. A Mode S transponder recognizes the short P_4 pulse and does not reply to this interrogation.

3.1.2.1.5.1.3 *Pulse intervals.* The pulse intervals between P_1 , P_2 and P_3 shall be as defined in 3.1.1.4.3 and 3.1.1.4.4. The pulse interval between P_3 and P_4 shall be 2 plus or minus 0.05 microsecond.

3.1.2.1.5.1.4 *Pulse amplitudes.* Relative amplitudes between pulses P_1 , P_2 and P_3 shall be in accordance with 3.1.1.5. The amplitude of P_4 shall be within 1 dB of the amplitude of P_3 .

3.1.2.1.5.2 *Mode S interrogation.* The Mode S interrogation shall consist of three pulses: P_1 , P_2 and P_6 as shown in Figure 3-4.

Note.— P_6 is preceded by a $P_1 - P_2$ pair which suppresses replies from Mode A/C transponders to avoid synchronous garble due to random triggering by the Mode S interrogation. The sync phase reversal within P_6 is the timing mark for demodulation of a series of time intervals (chips) of 0.25 microsecond duration. This series of chips starts 0.5 microsecond after the sync phase reversal and ends 0.5 microsecond before the trailing edge of P_6 . A phase reversal may or may not precede each chip to encode its binary information value.

3.1.2.1.5.2.1 *Mode S side-lobe suppression.* The P_5 pulse shall be used with the Mode S-only all-call interrogation (UF = 11, see 3.1.2.5.2) to prevent replies from aircraft in the side and back lobes of the antenna (3.1.2.1.5.2.5). When used, P_5 shall be transmitted using a separate antenna pattern.

Note 1.— The action of P_5 is automatic. Its presence, if of sufficient amplitude at the receiving location, masks the sync phase reversal of P_6 .

Note 2.— The P_5 pulse may be used with other Mode S interrogations.

3.1.2.1.5.2.2 *Sync phase reversal.* The first phase reversal in the P_6 pulse shall be the sync phase reversal. It shall be the timing reference for subsequent transponder operations related to the interrogation.

3.1.2.1.5.2.3 *Data phase reversals.* Each data phase reversal shall occur only at a time interval (N times 0.25) plus or minus 0.02 microsecond (N equal to, or greater than 2) after the sync phase reversal. The 16.25-microsecond P_6 pulse shall contain at most 56 data phase reversals. The 30.25-microsecond P_6 pulse shall contain at most 112 data phase reversals. The last chip, that is the 0.25-microsecond time interval following the last data phase reversal position, shall be followed by a 0.5-microsecond guard interval.

Note.— The 0.5-microsecond guard interval following the last chip prevents the trailing edge of P_6 from interfering with the demodulation process.

3.1.2.1.5.2.4 *Intervals.* The pulse interval between P_1 and P_2 shall be 2 plus or minus 0.05 microsecond. The interval between the leading edge of P_2 and the sync phase reversal of P_6 shall be 2.75 plus or minus 0.05 microsecond. The leading edge of P_6 shall occur 1.25 plus or minus 0.05 microsecond before the sync phase reversal. P_5 , if transmitted, shall be centred over the sync phase reversal; the leading edge of P_5 shall occur 0.4 plus or minus 0.05 microsecond before the sync phase reversal.

3.1.2.1.5.2.5 *Pulse amplitudes.* The amplitude of P_2 and the amplitude of the first microsecond of P_6 shall be greater than the amplitude of P_1 minus 0.25 dB. Exclusive of the amplitude transients associated with phase reversals, the amplitude variation of P_6 shall be less than 1 dB and the amplitude variation between successive chips in P_6 shall be less than 0.25 dB. The radiated amplitude of P_5 at the antenna of the transponder shall be:

- a) equal to or greater than the radiated amplitude of P_6 from the side-lobe transmissions of the antenna radiating P_6 ; and
- b) at a level lower than 9 dB below the radiated amplitude of P_6 within the desired arc of interrogation.

3.1.2.2 REPLY SIGNALS-IN-SPACE CHARACTERISTICS

3.1.2.2.1 *Reply carrier frequency.* The carrier frequency of all replies (downlink transmissions) from transponders with Mode S capabilities shall be 1 090 plus or minus 1 MHz.

3.1.2.2.2 *Reply spectrum.* The spectrum of a Mode S reply about the carrier frequency shall not exceed the limits specified in Figure 3-5.

3.1.2.2.3 *Polarization.* Polarization of the reply transmissions shall be nominally vertical.

3.1.2.2.4 *Modulation.* The Mode S reply shall consist of a preamble and a data block. The preamble shall be a 4-pulse sequence and the data block shall be binary pulse-position modulated at a 1 megabit per second data rate.

3.1.2.2.4.1 *Pulse shapes.* Pulse shapes shall be as defined in Table 3-2. All values are in microseconds.

3.1.2.2.5 *Mode S reply.* The Mode S reply shall be as shown in Figure 3-6. The data block in Mode S replies shall consist of either 56 or 112 information bits.

3.1.2.2.5.1 *Pulse intervals.* All reply pulses shall start at a defined multiple of 0.5 microsecond from the first transmitted pulse. The tolerance in all cases shall be plus or minus 0.05 microsecond.

3.1.2.2.5.1.1 *Reply preamble.* The preamble shall consist of four pulses, each with a duration of 0.5 microsecond. The pulse intervals from the first transmitted pulse to the second, third and fourth transmitted pulses shall be 1, 3.5 and 4.5 microseconds, respectively.

3.1.2.2.5.1.2 *Reply data pulses.* The reply data block shall begin 8 microseconds after the leading edge of the first transmitted pulse. Either 56 or 112 one-microsecond bit intervals shall be assigned to each transmission. A 0.5-microsecond pulse shall be transmitted either in the first or in the second half of each interval. When a pulse transmitted in the second half of one interval is followed by another pulse transmitted in the first half of the next interval, the two pulses merge and a one-microsecond pulse shall be transmitted.

3.1.2.2.5.2 *Pulse amplitudes.* The pulse amplitude variation between one pulse and any other pulse in a Mode S reply shall not exceed 2 dB.

3.1.2.3 MODE S DATA STRUCTURE

3.1.2.3.1 DATA ENCODING

3.1.2.3.1.1 *Interrogation data.* The interrogation data block shall consist of the sequence of 56 or 112 data chips positioned after the data phase reversals within P_6 (3.1.2.1.5.2.3). A 180-degree carrier phase reversal preceding a chip shall characterize that chip as a binary ONE. The absence of a preceding phase reversal shall denote a binary ZERO.

3.1.2.3.1.2 *Reply data.* The reply data block shall consist of 56 or 112 data bits formed by binary pulse position modulation encoding of the reply data as described in 3.1.2.2.5.1.2. A pulse transmitted in the first half of the interval shall represent a binary ONE whereas a pulse transmitted in the second half shall represent a binary ZERO.

3.1.2.3.1.3 *Bit numbering.* The bits shall be numbered in the order of their transmission, beginning with bit 1. Unless otherwise stated, numerical values encoded by groups (fields) of bits shall be encoded using positive binary notation and the first bit transmitted shall be the most significant bit (MSB). Information shall be coded in fields which consist of at least one bit.

Note.— In the description of Mode S formats the decimal equivalent of the binary code formed by the bit sequence within a field is used as the designator of the field function or command.

3.1.2.3.2 FORMATS OF MODE S INTERROGATIONS AND REPLIES

Note.— A summary of all Mode S interrogation and reply formats is presented in Figures 3-7 and 3-8. A summary of all fields appearing in uplink and downlink formats is given in Table 3-3 and a summary of all subfields is given in Table 3-4.

3.1.2.3.2.1 *Essential fields.* Every Mode S transmission shall contain two essential fields. One is a descriptor which shall uniquely define the format of the transmission. This shall appear at the beginning of the transmission for all formats. The descriptors are designated by the UF (uplink format) or DF (downlink format) fields. The second essential field shall be a 24-bit field appearing at the end of each transmission and shall contain parity information. In all uplink and in currently defined downlink formats parity information shall be overlaid either on the aircraft address (3.1.2.4.1.2.3.1) or on the interrogator identifier according to 3.1.2.3.3.2. The designators are AP (address/parity) or PI (parity/interrogator identifier).

Note.— The remaining coding space is used to transmit the mission fields. For specific functions, a specific set of mission fields is prescribed. Mode S mission fields have two-letter designators. Subfields may appear within mission fields. Mode S subfields are labelled with three-letter designators.

3.1.2.3.2.1.1 *UF: Uplink format.* This uplink format field (5 bits long except in format 24 where it is 2 bits long) shall serve as the uplink format descriptor in all Mode S interrogations and shall be coded according to Figure 3-7.

3.1.2.3.2.1.2 *DF: Downlink format.* This downlink format field (5 bits long except in format 24 where it is 2 bits long) shall serve as the downlink format descriptor in all Mode S replies and shall be coded according to Figure 3-8.

3.1.2.3.2.1.3 *AP: Address/parity.* This 24-bit (33-56 or 89-112) field shall appear in all uplink and currently defined downlink formats except the Mode S-only all-call reply, DF = 11. The field shall contain parity overlaid on the aircraft address according to 3.1.2.3.3.2.

3.1.2.3.2.1.4 *PI: Parity/interrogator identifier.* This 24-bit (33-56) or (89-112) downlink field shall have parity overlaid on the interrogator's identity code according to 3.1.2.3.3.2 and shall appear in the Mode S all-call reply, DF = 11 and in the extended squitter, DF = 17 or DF = 18. If the reply is made in response to a Mode A/C/S all-call, a Mode S-only all-call with CL field (3.1.2.5.2.1.3) and IC field (3.1.2.5.2.1.2) equal to 0, or is an acquisition or an extended squitter (3.1.2.8.5, 3.1.2.8.6 or 3.1.2.8.7), the II and the SI codes shall be 0.

3.1.2.3.2.1.5 *DP: Data parity.* This 24-bit (89-112) downlink field shall contain the parity overlaid on a "Modified AA" field which is established by performing a modulo-2 summation (e.g. Exclusive-Or function) of the discrete address most significant 8 bits and BDS1, BDS2, where BDS1 (3.1.2.6.11.2.2) and BDS2 (3.1.2.6.11.2.3) are provided by the "RR" (3.1.2.6.1.2) and "RRS" (3.1.2.6.1.4.1) as specified in 3.1.2.6.11.2.2 and 3.1.2.6.11.2.3.

Example:

Discrete address	=	AA AA AA Hex	=	1010	1010	1010	1010	1010	1010
BDS1, BDS2	=	5F 00 00 Hex	=	0101	1111	0000	0000	0000	0000
Discrete address	\oplus	BDS1, BDS2 Hex	=	1111	0101	1010	1010	1010	1010
"Modified AA"	=	F5 AA AA Hex	=	1111	0101	1010	1010	1010	1010

where " \oplus " prescribes modulo-2 addition

The resulting “Modified AA” field then represents the 24-bit sequence (a1, a2...a24) that shall be used to generate the DP field in accordance with paragraph 3.1.2.3.3.2.

The DP field shall be used in DF=20 and DF=21 replies if the transponder is capable of supporting the DP field and if the overlay control (OVC - 3.1.2.6.1.4.1.i) bit is set to one (1) in the interrogation requesting downlink of GICB registers.

3.1.2.3.2.2 *Unassigned coding space.* Unassigned coding space shall contain all ZEROs as transmitted by interrogators and transponders.

Note.— Certain coding space indicated as unassigned in this section is reserved for other applications such as ACAS, data link, etc.

3.1.2.3.2.3 *Zero and unassigned codes.* A zero code assignment in all defined fields shall indicate that no action is required by the field. In addition, codes not assigned within the fields shall indicate that no action is required.

Note.— The provisions of 3.1.2.3.2.2 and 3.1.2.3.2.3 ensure that future assignments of previously unassigned coding space will not result in ambiguity. That is, Mode S equipment in which the new coding has not been implemented will clearly indicate that no information is being transmitted in newly assigned coding space.

3.1.2.3.2.4 *Formats reserved for military use.* States shall ensure that uplink formats are only used for selectively addressed interrogations and that transmissions of uplink or downlink formats do not exceed the RF power, interrogation rate, reply rate and squitter rate requirements of Annex 10.

3.1.2.3.2.4.1 **Recommendation.**— *Through investigation and validation, States should ensure that military applications do not unduly affect the existing 1 030/1 090 MHz civil aviation operations environment.*

3.1.2.3.3 ERROR PROTECTION

3.1.2.3.3.1 *Technique.* Parity check coding shall be used within Mode S interrogations and replies to provide protection against the occurrence of errors.

3.1.2.3.3.1.1 *Parity check sequence.* A sequence of 24 parity check bits shall be generated by the rule described in 3.1.2.3.3.1.2 and shall be incorporated into the field formed by the last 24 bits of all Mode S transmissions. The 24 parity check bits shall be combined with either the address coding or the interrogator identifier coding as described in 3.1.2.3.3.2. The resulting combination then forms either the AP (address/parity, 3.1.2.3.2.1.3) field or the PI (parity/interrogator identifier, 3.1.2.3.2.1.4) field.

3.1.2.3.3.1.2 *Parity check sequence generation.* The sequence of 24 parity bits (p_1, p_2, \dots, p_{24}) shall be generated from the sequence of information bits (m_1, m_2, \dots, m_k) where k is 32 or 88 for short or long transmissions respectively. This shall be done by means of a code generated by the polynomial:

$$G(x) = 1 + x^3 + x^{10} + x^{12} + x^{13} + x^{14} + x^{15} + x^{16} \\ + x^{17} + x^{18} + x^{19} + x^{20} + x^{21} + x^{22} + x^{23} + x^{24}$$

When by the application of binary polynomial algebra, $x^{24} [M(x)]$ is divided by $G(x)$ where the information sequence $M(x)$ is:

$$m_k + m_{k-1}x + m_{k-2}x^2 + \dots + m_1x^{k-1}$$

the result is a quotient and a remainder $R(x)$ of degree less than 24. The bit sequence formed by this remainder represents the parity check sequence. Parity bit p_i , for any i from 1 to 24, is the coefficient of x^{24-i} in $R(x)$.

Note.— The effect of multiplying $M(x)$ by x^{24} is to append 24 ZERO bits to the end of the sequence.

3.1.2.3.3.2 *AP and PI field generation.* Different address parity sequences shall be used for the uplink and downlink.

Note.— The uplink sequence is appropriate for a transponder decoder implementation. The downlink sequence facilitates the use of error correction in downlink decoding.

The code used in uplink AP field generation shall be formed as specified below from either the aircraft address (3.1.2.4.1.2.3.1.1), the all-call address (3.1.2.4.1.2.3.1.2) or the broadcast address (3.1.2.4.1.2.3.1.3).

The code used in downlink AP field generation shall be formed directly from the sequence of 24 Mode S address bits (a_1, a_2, \dots, a_{24}), where a_i is the i -th bit transmitted in the aircraft address (AA) field of an all-call reply (3.1.2.5.2.2.2).

The code used in downlink PI field generation shall be formed by a sequence of 24 bits (a_1, a_2, \dots, a_{24}), where the first 17 bits are ZEROS, the next three bits are a replica of the code label (CL) field (3.1.2.5.2.1.3) and the last four bits are a replica of the interrogator code (IC) field (3.1.2.5.2.1.2).

Note.— The PI code is not used in uplink transmissions.

A modified sequence (b_1, b_2, \dots, b_{24}) shall be used for uplink AP field generation. Bit b_i is the coefficient of x^{48-i} in the polynomial $G(x)A(x)$, where:

$$A(x) = a_1x^{23} + a_2x^{22} + \dots + a_{24}$$

and $G(x)$ is as defined in 3.1.2.3.3.1.2.

In the aircraft address a_i shall be the i -th bit transmitted in the AA field of an all-call reply. In the all-call and broadcast addresses a_i shall equal 1 for all values of i .

3.1.2.3.3.2.1 *Uplink transmission order.* The sequence of bits transmitted in the uplink AP field is:

$$t_{k+1}, t_{k+2}, \dots, t_{k+24}$$

where the bits are numbered in order of transmission, starting with $k + 1$.

In uplink transmissions:

$$t_{k+i} = b_i \oplus p_i$$

where “ \oplus ” prescribes modulo-2 addition: i equals 1 is the first bit transmitted in the AP field.

3.1.2.3.3.2.2 *Downlink transmission order.* The sequence of bits transmitted in the downlink AP and PI field is:

$$t_{k+1}, t_{k+2}, \dots, t_{k+24}$$

where the bits are numbered in order of transmission, starting with $k + 1$. In downlink transmissions:

$$t_{k+i} = a_i \oplus p_i$$

where “ \oplus ” prescribes modulo-2 addition: i equals 1 is the first bit transmitted in the AP or PI field.

3.1.2.4 GENERAL INTERROGATION-REPLY PROTOCOL

3.1.2.4.1 *Transponder transaction cycle.* A transponder transaction cycle shall begin when the SSR Mode S transponder has recognized an interrogation. The transponder shall then evaluate the interrogation and determine whether it shall be accepted. If accepted, it shall then process the received interrogation and generate a reply, if appropriate. The transaction cycle shall end when:

- a) any one of the necessary conditions for acceptance has not been met, or
- b) an interrogation has been accepted and the transponder has either:
 - 1) completed the processing of the accepted interrogation if no reply is required, or
 - 2) completed the transmission of a reply.

A new transponder transaction cycle shall not begin until the previous cycle has ended.

3.1.2.4.1.1 *Interrogation recognition.* SSR Mode S transponders shall be capable of recognizing the following distinct types of interrogations:

- a) Modes A and C;
- b) intermode; and
- c) Mode S.

Note.— *The recognition process is dependent upon the signal input level and the specified dynamic range (3.1.2.10.1).*

3.1.2.4.1.1.1 *Mode A and Mode C interrogation recognition.* A Mode A or Mode C interrogation shall be recognized when a $P_1 - P_3$ pulse pair meeting the requirements of 3.1.1.4 has been received, and the leading edge of a P_4 pulse with an amplitude that is greater than a level 6 dB below the amplitude of P_3 is not received within the interval from 1.7 to 2.3 microseconds following the leading edge of P_3 .

If a $P_1 - P_2$ suppression pair and a Mode A or Mode C interrogation are recognized simultaneously, the transponder shall be suppressed. An interrogation shall not be recognized as Mode A or Mode C if the transponder is in suppression (3.1.2.4.2). If a Mode A and a Mode C interrogation are recognized simultaneously the transponder shall complete the transaction cycle as if only a Mode C interrogation had been recognized.

3.1.2.4.1.1.2 *Intermode interrogation recognition.* An intermode interrogation shall be recognized when a $P_1 - P_3 - P_4$ pulse triplet meeting the requirements of 3.1.2.1.5.1 is received. An interrogation shall not be recognized as an intermode interrogation if:

- a) the received amplitude of the pulse in the P_4 position is smaller than 6 dB below the amplitude of P_3 ; or
- b) the pulse interval between P_3 and P_4 is larger than 2.3 microseconds or shorter than 1.7 microseconds; or
- c) the received amplitude of P_1 and P_3 is between MTL and -45 dBm and the pulse duration of P_1 or P_3 is less than 0.3 microsecond; or
- d) the transponder is in suppression (3.1.2.4.2).

If a $P_1 - P_2$ suppression pair and a Mode A or Mode C intermode interrogation are recognized simultaneously the transponder shall be suppressed.

3.1.2.4.1.1.3 *Mode S interrogation recognition.* A Mode S interrogation shall be recognized when a P_6 pulse is received with a sync phase reversal within the interval from 1.20 to 1.30 microseconds following the leading edge of P_6 . A Mode S interrogation shall not be recognized if a sync phase reversal is not received within the interval from 1.05 to 1.45 microseconds following the leading edge of P_6 .

3.1.2.4.1.2 *Interrogation acceptance.* Recognition according to 3.1.2.4.1 shall be a prerequisite for acceptance of any interrogation.

3.1.2.4.1.2.1 *Mode A and Mode C interrogation acceptance.* Mode A and Mode C interrogations shall be accepted when recognized (3.1.2.4.1.1.1).

3.1.2.4.1.2.2 *Intermode interrogation acceptance*

3.1.2.4.1.2.2.1 *Mode A/C/S all-call interrogation acceptance.* A Mode A/C/S all-call interrogation shall be accepted if the trailing edge of P_4 is received within 3.45 to 3.75 microseconds following the leading edge of P_3 and no lockout condition (3.1.2.6.9) prevents acceptance. A Mode A/C/S all-call shall not be accepted if the trailing edge of P_4 is received earlier than 3.3 or later than 4.2 microseconds following the leading edge of P_3 , or if a lockout condition (3.1.2.6.9) prevents acceptance.

3.1.2.4.1.2.2.2 *Mode A/C-only all-call interrogation acceptance.* A Mode A/C-only all-call interrogation shall not be accepted by a Mode S transponder.

Note.— *The technical condition for non-acceptance of a Mode A/C-only all-call is given in the preceding paragraph by the requirement for rejecting an intermode interrogation with a P_4 pulse having a trailing edge following the leading edge of P_3 by less than 3.3 microseconds.*

3.1.2.4.1.2.3 *Mode S interrogation acceptance.* A Mode S interrogation shall only be accepted if:

- a) the transponder is capable of processing the uplink format (UF) of the interrogation (3.1.2.3.2.1.1);
- b) the address of the interrogation matches one of the addresses as defined in 3.1.2.4.1.2.3.1 implying that parity is established, as defined in 3.1.2.3.3;
- c) in the case of an all-call interrogation, no all-call lockout condition applies, as defined in 3.1.2.6.9; and
- d) the transponder is capable of processing the uplinked data of a long air-air surveillance (ACAS) interrogation (UF-16) and presenting it at an output interface as prescribed in 3.1.2.10.5.2.2.1.

Note.— *A Mode S interrogation may be accepted if the conditions specified in 3.1.2.4.1.2.3 a) and b) are met and the transponder is not capable of both processing the uplinked data of a Comm-A interrogation (UF=20 and 21) and presenting it at an output interface as prescribed in 3.1.2.10.5.2.2.1.*

3.1.2.4.1.2.3.1 *Addresses.* Mode S interrogations shall contain either:

- a) aircraft address; or
- b) the all-call address; or
- c) the broadcast address.

3.1.2.4.1.2.3.1.1 *Aircraft address.* If the aircraft's address is identical to the address extracted from a received interrogation according to the procedure of 3.1.2.3.3.2 and 3.1.2.3.3.2.1, the extracted address shall be considered correct for purposes of Mode S interrogation acceptance.

3.1.2.4.1.2.3.1.2 *All-call address.* A Mode S-only all-call interrogation (uplink format UF = 11) shall contain an address, designated the all-call address, consisting of twenty-four consecutive ONEs. If the all-call address is extracted from a received interrogation with format UF = 11 according to the procedure of 3.1.2.3.3.2 and 3.1.2.3.3.2.1, the address shall be considered correct for Mode S-only all-call interrogation acceptance.

3.1.2.4.1.2.3.1.3 *Broadcast address.* To broadcast a message to all Mode S transponders within the interrogator beam, a Mode S interrogation uplink format 20 or 21 shall be used and an address of twenty-four consecutive ONEs shall be substituted for the aircraft address. If the UF code is 20 or 21 and this broadcast address is extracted from a received interrogation according to the procedure of 3.1.2.3.3.2 and 3.1.2.3.3.2.1, the address shall be considered correct for Mode S broadcast interrogation acceptance.

Note.— *Transponders associated with airborne collision avoidance systems also accept a broadcast with UF = 16.*

3.1.2.4.1.3 *Transponder replies.* Mode S transponders shall transmit the following reply types:

- a) Mode A and Mode C replies; and
- b) Mode S replies.

3.1.2.4.1.3.1 *Mode A and Mode C replies.* A Mode A (Mode C) reply shall be transmitted as specified in 3.1.1.6 when a Mode A (Mode C) interrogation has been accepted.

3.1.2.4.1.3.2 *Mode S replies.* Replies to other than Mode A and Mode C interrogations shall be Mode S replies.

3.1.2.4.1.3.2.1 *Replies to intermode interrogations.* A Mode S reply with downlink format 11 shall be transmitted in accordance with the provisions of 3.1.2.5.2.2 when a Mode A/C/S all-call interrogation has been accepted. Equipment certified on or after 1 January 2020 shall not reply to Intermode Mode A/C/S all-call interrogations.

Note.— *Since Mode S transponders do not accept Mode A/C-only all-call interrogations, no reply is generated.*

3.1.2.4.1.3.2.2 *Replies to Mode S interrogations.* The information content of a Mode S reply shall reflect the conditions existing in the transponder after completion of all processing of the interrogation eliciting that reply. The correspondence between uplink and downlink formats shall be as summarized in Table 3-5.

Note.— *Four categories of Mode S replies may be transmitted in response to Mode S interrogations:*

- a) *Mode S all-call replies (DF = 11);*
- b) *surveillance and standard-length communications replies (DF = 4, 5, 20 and 21);*
- c) *extended length communications replies (DF = 24); and*
- d) *air-air surveillance replies (DF = 0 and 16).*

3.1.2.4.1.3.2.2.1 *Replies to SSR Mode S-only all-call interrogations.* The downlink format of the reply to a Mode S-only all-call interrogation (if required) shall be DF = 11. The reply content and rules for determining the requirement to reply shall be as defined in 3.1.2.5.

Note.— *A Mode S reply may or may not be transmitted when a Mode S interrogation with UF = 11 has been accepted.*

3.1.2.4.1.3.2.2.2 *Replies to surveillance and standard length communications interrogations.* A Mode S reply shall be transmitted when a Mode S interrogation with UF = 4, 5, 20 or 21 and an aircraft address has been accepted. The contents of these interrogations and replies shall be as defined in 3.1.2.6.

Note.— If a Mode S interrogation with $UF = 20$ or 21 and a broadcast address is accepted, no reply is transmitted (3.1.2.4.1.2.3.1.3).

3.1.2.4.1.3.2.2.3 *Replies to extended length communications interrogations.* A series of Mode S replies ranging in number from 0 to 16 shall be transmitted when a Mode S interrogation with $UF = 24$ has been accepted. The downlink format of the reply (if any) shall be $DF = 24$. Protocols defining the number and content of the replies shall be as defined in 3.1.2.7.

3.1.2.4.1.3.2.2.4 *Replies to air-air surveillance interrogations.* A Mode S reply shall be transmitted when a Mode S interrogation with $UF = 0$ and an aircraft address has been accepted. The contents of these interrogations and replies shall be as defined in 3.1.2.8.

3.1.2.4.2 SUPPRESSION

3.1.2.4.2.1 *Effects of suppression.* A transponder in suppression (3.1.1.7.4) shall not recognize Mode A, Mode C or intermode interrogations if either the P_1 pulse alone or both the P_1 and P_3 pulses of the interrogation are received during the suppression interval. Suppression shall not affect the recognition of, acceptance of, or replies to Mode S interrogations.

3.1.2.4.2.2 *Suppression pairs.* The two-pulse Mode A/C suppression pair defined in 3.1.1.7.4.1 shall initiate suppression in a Mode S transponder regardless of the position of the pulse pair in a group of pulses, provided the transponder is not already suppressed or in a transaction cycle.

Note.— The $P_3 - P_4$ pair of the Mode A/C-only all-call interrogation both prevents a reply and initiates suppression. Likewise, the $P_1 - P_2$ preamble of a Mode S interrogation initiates suppression independently of the waveform that follows it.

3.1.2.4.2.3 Suppression in presence of S_1 pulse shall be as defined in 3.1.1.7.4.3.

3.1.2.5 INTERMODE AND MODE S ALL-CALL TRANSACTIONS

3.1.2.5.1 INTERMODE TRANSACTIONS

Note.— Intermode transactions permit the surveillance of Mode A/C-only aircraft and the acquisition of Mode S aircraft. The Mode A/C/S all-call interrogation allows Mode A/C-only and Mode S transponders to be interrogated by the same transmissions. The Mode A/C-only all-call interrogation makes it possible to elicit replies only from Mode A/C transponders. In multisite scenarios, the interrogator must transmit its identifier code in the Mode S only all-call interrogation. Thus, a pair of Mode S-only and Mode A/C-only all-call interrogations are used. The intermode interrogations are defined in 3.1.2.1.5.1 and the corresponding interrogation-reply protocols are defined in 3.1.2.4.

3.1.2.5.2 MODE S-ONLY ALL-CALL TRANSACTIONS

Note.— These transactions allow the ground to acquire Mode S aircraft by use of an interrogation addressed to all Mode S-equipped aircraft. The reply is via downlink format 11 which returns the aircraft address. The interrogation-reply protocols are defined in 3.1.2.4.

3.1.2.5.2.1 Mode S-only all-call interrogation, uplink format 11

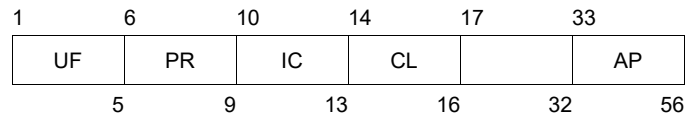

The format of this interrogation shall consist of these fields:

<i>Field</i>	<i>Reference</i>
UF uplink format	3.1.2.3.2.1.1
PR probability of reply	3.1.2.5.2.1.1
IC interrogator code	3.1.2.5.2.1.2
CL code label	3.1.2.5.2.1.3
spare — 16 bits	
AP address/parity	3.1.2.3.2.1.3

3.1.2.5.2.1.1 *PR: Probability of reply.* This 4-bit (6-9) uplink field shall contain commands to the transponder specifying the probability of reply to that interrogation (3.1.2.5.4). Codes are as follows:

0	signifies reply with probability of 1
1	signifies reply with probability of 1/2
2	signifies reply with probability of 1/4
3	signifies reply with probability of 1/8
4	signifies reply with probability of 1/16
5, 6, 7	not assigned
8	signifies disregard lockout, reply with probability of 1
9	signifies disregard lockout, reply with probability of 1/2
10	signifies disregard lockout, reply with probability of 1/4
11	signifies disregard lockout, reply with probability of 1/8
12	signifies disregard lockout, reply with probability of 1/16
13, 14, 15	not assigned.

3.1.2.5.2.1.2 *IC: Interrogator code.* This 4-bit (10-13) uplink field shall contain either the 4-bit interrogator identifier code (3.1.2.5.2.1.2.3) or the lower 4 bits of the 6-bit surveillance identifier code (3.1.2.5.2.1.2.4) depending on the value of the CL field (3.1.2.5.2.1.3).

3.1.2.5.2.1.2.1 **Recommendation.**— *It is recommended that whenever possible an interrogator should operate using a single interrogator code.*

3.1.2.5.2.1.2.2 *The use of multiple interrogator codes by one interrogator.* An interrogator shall not interleave Mode S-only all-call interrogations using different interrogator codes.

Note.— *An explanation of RF interference issues, sector size and impact on data link transactions is presented in the Aeronautical Surveillance Manual (Doc 9924).*

3.1.2.5.2.1.2.3 *II: Interrogator identifier.* This 4-bit value shall define an interrogator identifier (II) code. These II codes shall be assigned to interrogators in the range from 0 to 15. The II code value of 0 shall only be used for supplementary acquisition in conjunction with acquisition based on lockout override (3.1.2.5.2.1.4 and 3.1.2.5.2.1.5). When two II codes are assigned to one interrogator only, one II code shall be used for full data link purposes.

Note.— Limited data link activity including single segment Comm-A, uplink and downlink broadcast protocols and GICB extraction may be performed by both II codes.

3.1.2.5.2.1.2.4 *SI: Surveillance identifier.* This 6-bit value shall define a surveillance identifier (SI) code. These SI codes shall be assigned to interrogators in the range from 1 to 63. The SI code value of 0 shall not be used. The SI codes shall be used with the multisite lockout protocols (3.1.2.6.9.1). The SI codes shall not be used with the multisite communications protocols (3.1.2.6.11.3.2, 3.1.2.7.4 or 3.1.2.7.7).

3.1.2.5.2.1.3 *CL: Code label.* This 3-bit (14-16) uplink field shall define the contents of the IC field.

Coding (in binary)

000	signifies that the IC field contains the II code
001	signifies that the IC field contains SI codes 1 to 15
010	signifies that the IC field contains SI codes 16 to 31
011	signifies that the IC field contains SI codes 32 to 47
100	signifies that the IC field contains SI codes 48 to 63

The other values of the CL field shall not be used.

3.1.2.5.2.1.3.1 *Surveillance identifier (SI) code capability report.* Transponders which process the SI codes (3.1.2.5.2.1.2.4) shall report this capability by setting bit 35 to 1 in the surveillance identifier capability (SIC) subfield of the MB field of the data link capability report (3.1.2.6.10.2.2).

3.1.2.5.2.1.4 *Operation based on lockout override*

Note 1.— The Mode S-only all-call lockout override provides the basis for acquisition of Mode S aircraft for interrogators that have not been assigned a unique IC (II or SI code) for full Mode S operation (protected acquisition by ensuring that no other interrogator on the same IC can lock out the target in the same coverage area).

Note 2.— Lockout override is possible using any interrogator code.

3.1.2.5.2.1.4.1 *Maximum Mode S-only all-call interrogation rate.* The maximum rate of Mode S-only all-call interrogations made by an interrogator using acquisition based on lockout override shall depend on the reply probability as follows:

- a) for a reply probability equal to 1.0:
 - the smaller of 3 interrogations per 3 dB beam dwell or 30 interrogations per second;
- b) for a reply probability equal to 0.5:
 - the smaller of 5 interrogations per 3 dB beam dwell or 60 interrogations per second; and
- c) for a reply probability equal to 0.25 or less:
 - the smaller of 10 interrogations per 3 dB beam dwell or 125 interrogations per second.

Note.— These limits have been defined in order to minimize the RF pollution generated by such a method while keeping a minimum of replies to allow acquisition of aircraft within a beam dwell.

3.1.2.5.2.1.4.2 **Recommendation.**— *Passive acquisition without using all-call interrogations should be used in the place of lockout override.*

Note.— *The Aeronautical Surveillance Manual (Doc 9924) provides guidance on different passive acquisition methods.*

3.1.2.5.2.1.4.3 *Field content for a selectively addressed interrogation used by an interrogator without an assigned interrogator code.* An interrogator that has not been assigned with a unique discrete interrogator code and is authorized to transmit shall use the II code 0 to perform the selective interrogations. In this case, selectively addressed interrogations used in connection with acquisition using lockout override shall have interrogation field contents restricted as follows:

UF = 4, 5, 20 or 21
 PC = 0
 DI = 7
 IIS = 0
 LOS = 0 except as specified in 3.1.2.5.2.1.5
 TMS = 0

3.1.2.5.2.1.4.4 An interrogator that has not been assigned with a unique discrete interrogator code and is authorized to transmit using II code 0 shall not attempt to extract an air-initiated Comm-B message announced by DR = 1 or 3.

Note.— *These restrictions permit surveillance transaction, GICB transaction and Comm-B broadcast extraction, but prevent the interrogation from making any changes to transponder multisite lockout or communications protocol states.*

3.1.2.5.2.1.5 *Supplementary acquisition using II equals 0*

Note 1.— *The acquisition technique defined in 3.1.2.5.2.1.4 provides rapid acquisition for most aircraft. Due to the probabilistic nature of the process, it may take many interrogations to acquire the last aircraft of a large set of aircraft in the same beam dwell and near the same range (termed a local garble zone). Acquisition performance is greatly improved for the acquisition of these aircraft through the use of limited selective lockout using II equals 0.*

Note 2.— *Supplementary acquisition consists of locking out acquired aircraft to II=0 followed by acquisition by means of the Mode S-only all-call interrogation with II=0. Only the aircraft not yet acquired and not yet locked-out will reply resulting in an easier acquisition.*

3.1.2.5.2.1.5.1 *Lockout within a beam dwell*

3.1.2.5.2.1.5.1.1 **Recommendation.**— *When II equals 0 lockout is used to supplement acquisition, all aircraft within the beam dwell of the aircraft being acquired should be commanded to lock out to II equals 0, not just those in the garble zone.*

Note.— *Lockout of all aircraft in the beam dwell will reduce the amount of all-call fruit replies generated to the II equals 0 all-call interrogations.*

3.1.2.5.2.1.5.2 *Duration of lockout*

3.1.2.5.2.1.5.2.1 Interrogators performing supplementary acquisition using II equals 0 shall perform acquisition by transmitting a lockout command for no more than two consecutive scans to each of the aircraft already acquired in the beam dwell containing the garble zone and shall not repeat it before 48 seconds have elapsed.

Note.— *Minimizing the lockout time reduces the probability of conflict with the acquisition activities of a neighbouring interrogator that is also using II equals 0 for supplementary acquisition.*

3.1.2.5.2.1.5.2.2 **Recommendation.**— *Mode S only all-call interrogations with II=0 for the purpose of supplementary acquisition should take place within a garble zone over no more than two consecutive scans or a maximum of 18 seconds.*

3.1.2.5.2.2 All-call reply, downlink format 11

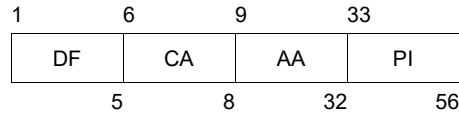

The reply to the Mode S-only all-call or the Mode A/C/S all-call interrogation shall be the Mode S all-call reply, downlink format 11. The format of this reply shall consist of these fields:

<i>Field</i>	<i>Reference</i>
DF downlink format	3.1.2.3.2.1.2
CA capability	3.1.2.5.2.2.1
AA address announced	3.1.2.5.2.2.2
PI parity/interrogator identifier	3.1.2.3.2.1.4

3.1.2.5.2.2.1 *CA: Capability.* This 3-bit (6-8) downlink field shall convey information on the transponder level, the additional information below, and shall be used in formats DF = 11 and DF = 17.

Coding

- 0 signifies Level 1 transponder (surveillance only), and no ability to set CA code 7 and either airborne or on the ground
- 1 reserved
- 2 reserved
- 3 reserved
- 4 signifies Level 2 or above transponder and ability to set CA code 7 and on the ground
- 5 signifies Level 2 or above transponder and ability to set CA code 7 and airborne
- 6 signifies Level 2 or above transponder and ability to set CA code 7 and either airborne or on the ground
- 7 signifies the DR field is not equal to 0 or the FS field equals 2, 3, 4 or 5, and either airborne or on the ground

When the conditions for CA code 7 are not satisfied, aircraft with Level 2 or above transponders:

- a) that do not have automatic means to set the on-the-ground condition shall use CA code 6; and
- b) with automatic on-the-ground determination shall use CA code 4 when on the ground and 5 when airborne.

Data link capability reports (3.1.2.6.10.2.2) shall be available from aircraft installations that set CA code 4, 5, 6 or 7.

Note.— *CA codes 1 to 3 are reserved to maintain backward compatibility.*

3.1.2.5.2.2.2 *AA: Address announced.* This 24-bit (9-32) downlink field shall contain the aircraft address which provides unambiguous identification of the aircraft.

3.1.2.5.3 *Lockout protocol.* The all-call lockout protocol defined in 3.1.2.6.9 shall be used by the interrogator with respect to an aircraft once the address of that specific aircraft has been acquired by an interrogator provided that:

- the interrogator is using an IC code different from zero; and
- the aircraft is located in an area where the interrogator is authorized to use lockout.

Note 1.— Following acquisition, a transponder is interrogated by discretely addressed interrogations as prescribed in 3.1.2.6, 3.1.2.7 and 3.1.2.8 and the all-call lockout protocol is used to inhibit replies to further all-call interrogations.

Note 2.— Regional IC allocation bodies may define rules limiting the use of selective interrogation and lockout protocol (e.g. no lockout in defined limited area, use of intermittent lockout in defined areas, and no lockout of aircraft not yet equipped with SI code capability).

3.1.2.5.4 *Stochastic all-call protocol.* The transponder shall execute a random process upon acceptance of a Mode S-only all-call with a PR code equal to 1 to 4 or 9 to 12. A decision to reply shall be made in accordance with the probability specified in the interrogation. A transponder shall not reply if a PR code equal to 5, 6, 7, 13, 14 or 15 is received (3.1.2.5.2.1.1).

Note.— The random occurrence of replies makes it possible for the interrogator to acquire closely spaced aircraft, replies from which would otherwise synchronously garble each other.

3.1.2.6 ADDRESSED SURVEILLANCE AND STANDARD LENGTH COMMUNICATION TRANSACTIONS

Note 1.— The interrogations described in this section are addressed to specific aircraft. There are two basic interrogation and reply types, short and long. The short interrogations and replies are UF 4 and 5 and DF 4 and 5, while the long interrogations and replies are UF 20 and 21 and DF 20 and 21.

Note 2.— The communications protocols are given in 3.1.2.6.11. These protocols describe the control of the data exchange.

3.1.2.6.1 SURVEILLANCE, ALTITUDE REQUEST, UPLINK FORMAT 4

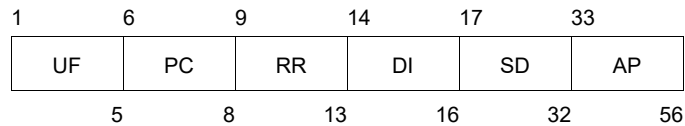

The format of this interrogation shall consist of these fields:

<i>Field</i>	<i>Reference</i>
UF uplink format	3.1.2.3.2.1.1
PC protocol	3.1.2.6.1.1
RR reply request	3.1.2.6.1.2
DI designator identification	3.1.2.6.1.3
SD special designator	3.1.2.6.1.4
AP address/parity	3.1.2.3.2.1.3

3.1.2.6.1.1 *PC: Protocol.* This 3-bit, (6-8) uplink field shall contain operating commands to the transponder. The PC field values 2 through 7 shall be ignored and the values 0 and 1 shall be processed for surveillance or Comm-A interrogations containing DI = 3 (3.1.2.6.1.4.1).

Coding

- 0 signifies no action
- 1 signifies non-selective all-call lockout (3.1.2.6.9.2)
- 2 not assigned
- 3 not assigned
- 4 signifies close out Comm-B (3.1.2.6.11.3.2.3)
- 5 signifies close out uplink ELM (3.1.2.7.4.2.8)
- 6 signifies close out downlink ELM (3.1.2.7.7.3)
- 7 not assigned.

3.1.2.6.1.2 *RR: Reply request.* This 5-bit, (9-13) uplink field shall command the length and content of a requested reply.

The last four bits of the 5-bit RR code, transformed into their decimal equivalent, shall designate the BDS1 code (3.1.2.6.11.2 or 3.1.2.6.11.3) of the requested Comm-B message if the most significant bit (MSB) of the RR code is 1 (RR is equal to or greater than 16).

Coding

- RR = 0-15 shall be used to request a reply with surveillance format (DF = 4 or 5);
- RR = 16-31 shall be used to request a reply with Comm-B format (DF = 20 or 21);
- RR = 16 shall be used to request transmission of an air-initiated Comm-B message according to 3.1.2.6.11.3 or to request the extraction of a Comm-B broadcast message according to 3.1.2.6.11.4;
- RR = 17 shall be used to request a data link capability report according to 3.1.2.6.10.2.2;
- RR = 18 shall be used to request aircraft identification according to 3.1.2.9;
- 19-31 are not assigned in section 3.1.

Note.— Codes 19-31 are reserved for applications such as data link communications, airborne collision avoidance systems (ACAS), etc.

3.1.2.6.1.3 *DI: Designator identification.* This 3-bit (14-16) uplink field shall identify the structure of the SD field (3.1.2.6.1.4).

Coding

- 0 signifies SD not assigned except for IIS, bits 21-27 and 29-32 are not assigned, and bit 28 contains the “OVC” (overlay control - 3.1.2.6.1.4.1 i)
- 1 signifies SD contains multisite and communications control information
- 2 signifies SD contains control data for extended squitter
- 3 signifies SD contains SI multisite lockout, broadcast and GICB control information, and bit 28 contains the “OVC” (overlay control - 3.1.2.6.1.4.1 i)
- 4-6 signifies SD not assigned
- 7 signifies SD contains extended data readout request, multisite and communications control information, and bit 28 contains the “OVC” (overlay control - 3.1.2.6.1.4.1 i)

3.1.2.6.1.4 *SD: Special designator.* This 16-bit (17-32) uplink field shall contain control codes which depend on the coding in the DI field.

Note.— The special designator (SD) field is provided to accomplish the transfer of multisite, lockout and communications control information from the ground station to the transponder.

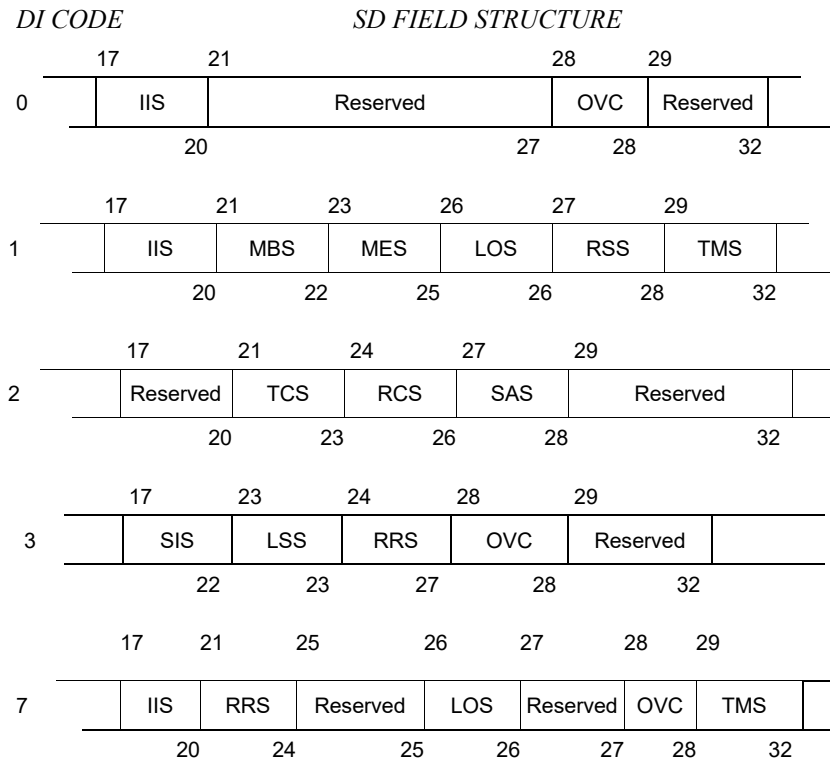

3.1.2.6.1.4.1 *Subfields in SD.* The SD field shall contain information as follows:

a) If DI = 0, 1 or 7:

IIS, the 4-bit (17-20) interrogator identifier subfield shall contain an assigned identifier code of the interrogator (3.1.2.5.2.1.2.3).

b) If DI = 0:

bits 21-27 and 29-32 are not assigned.

c) If DI = 1:

MBS, the 2-bit (21, 22) multisite Comm-B subfield shall have the following codes:

- 0 signifies no Comm-B action
- 1 signifies air-initiated Comm-B reservation request (3.1.2.6.11.3.1)
- 2 signifies Comm-B closeout (3.1.2.6.11.3.2.3)
- 3 not assigned.

MES, the 3-bit (23-25) multisite ELM subfield shall contain reservation and closeout commands for ELM as follows:

- 0 signifies no ELM action
- 1 signifies uplink ELM reservation request (3.1.2.7.4.1)
- 2 signifies uplink ELM closeout (3.1.2.7.4.2.8)
- 3 signifies downlink ELM reservation request (3.1.2.7.7.1.1)

- 4 signifies downlink ELM closeout (3.1.2.7.7.3)
- 5 signifies uplink ELM reservation request and downlink ELM closeout
- 6 signifies uplink ELM closeout and downlink ELM reservation request
- 7 signifies uplink ELM and downlink ELM closeouts.

RSS, the 2-bit (27, 28) reservation status subfield shall request the transponder to report its reservation status in the UM field. The following codes have been assigned:

- 0 signifies no request
- 1 signifies report Comm-B reservation status in UM
- 2 signifies report uplink ELM reservation status in UM
- 3 signifies report downlink ELM reservation status in UM.

d) If DI = 1 or 7:

LOS, the 1-bit (26) lockout subfield, if set to 1, shall signify a multisite lockout command from the interrogator indicated in IIS. LOS set to 0, shall be used to signify that no change in lockout state is commanded.

TMS, the 4-bit (29-32) tactical message subfield shall contain communications control information used by the data link avionics.

e) If DI = 7:

RRS, the 4-bit (21-24) reply request subfield in SD shall give the BDS2 code of a requested Comm-B reply.

Bits 25 and 27 are not assigned.

f) If DI = 2:

TCS, the 3-bit (21-23) type control subfield in SD shall control the extended squitter airborne and surface format types reported by the transponder and its response to Mode A/C, Mode A/C/S all-call and Mode S-only all-call interrogations. The following codes have been assigned:

- 0 signifies no surface format types or reply inhibit command
- 1 signifies surface format types for the next 15 seconds (see 3.1.2.6.1.4.2)
- 2 signifies surface format types for the next 60 seconds (see 3.1.2.6.1.4.3)
- 3 signifies cancel surface format types and reply inhibit commands
- 4-7 reserved.

The transponder shall be able to accept a new command even though a prior command has not as yet timed out.

RCS, the 3-bit (24-26) rate control subfield in SD shall control the squitter rate of the transponder when it is reporting the extended squitter surface type formats. This subfield shall have no effect on the transponder squitter rate when it is reporting the extended squitter airborne type formats. The following codes have been assigned:

- 0 signifies no surface extended squitter rate command
- 1 signifies report high surface extended squitter rate for 60 seconds
- 2 signifies report low surface extended squitter rate for 60 seconds
- 3-7 reserved.

Note 1.— The definition of high and low extended squitter rates is given in 3.1.2.8.6.4 and applies to the surface position, aircraft identification and category, and the operational status messages.

Note 2.— As stated in 3.1.2.8.5.2 d), acquisition squitters are transmitted when surface type format extended squitters are not being transmitted.

SAS, the 2-bit (27-28) surface antenna subfield in SD shall control the selection of the transponder diversity antenna that is used for (1) the extended squitter when the transponder is reporting the surface type formats, and (2) the acquisition squitter when the transponder is reporting the on-the-ground status. This subfield shall have no effect on the transponder diversity antenna selection when it is reporting the airborne status. The following codes have been assigned:

- 0 signifies no antenna command
- 1 signifies alternate top and bottom antennas for 120 seconds
- 2 signifies use bottom antenna for 120 seconds
- 3 signifies return to the default.

Note.— The top antenna is the default condition (3.1.2.8.6.5).

g) If DI = 3:

SIS, the 6-bit (17-22) surveillance identifier subfield in SD shall contain an assigned surveillance identifier code of the interrogator (3.1.2.5.2.1.2.4).

LSS, the 1-bit (23) lockout surveillance subfield, if set to 1, shall signify a multisite lockout command from the interrogator indicated in SIS. If set to 0, LSS shall signify that no change in lockout state is commanded.

RRS, the 4-bit (24-27) reply request subfield in SD shall contain the BDS2 code of a requested GICB register.

Bits 29 to 32 are not assigned.

h) If DI=4, 5 or 6 then the SD field has no meaning and shall not impact other transaction cycle protocols. These DI codes remain reserved until future assignment of the SD field.

i) If DI = 0, 3 or 7:

In addition to the requirements provided above, the “SD” shall contain the following:

“OVC”: The 1-bit (bit 28) “overlay control” subfield in “SD” is used by the interrogator to command that the data parity (“DP” 3.1.2.3.2.1.5) be overlaid upon the resulting reply to the interrogation in accordance with paragraph 3.1.2.6.11.2.5.

3.1.2.6.1.4.2 *TCS subfield equal to one (1) in the SD field for extended squitters.* When the TCS subfield in the SD field is set equal to one (1), it shall signify the following:

- a) broadcast of the extended squitter surface formats, including the surface position message (3.1.2.8.6.4.3), the identification and category message (3.1.2.8.6.4.4), the aircraft operational status message (3.1.2.8.6.4.6) and the aircraft status message (3.1.2.8.6.4.6) for the next 15 seconds at the appropriate rates on the top antenna for aircraft systems having the antenna diversity capability, except if otherwise specified by SAS (3.1.2.6.1.4.1 f));
- b) inhibit replies to Mode A/C, Mode A/C/S all-call and Mode S-only all-call interrogations for the next 15 seconds;
- c) broadcast of acquisition squitters as per 3.1.2.8.5 using antenna as specified in 3.1.2.8.5.3 a);
- d) does not impact the air/ground state reported via the CA, FS and VS fields;

- e) discontinue broadcast of the extended squitter airborne message formats; and
- f) broadcast of the extended squitter surface formats at the rates according to the TRS subfield unless commanded to transmit at the rates set by the RCS subfield.

3.1.2.6.1.4.3 *TCS subfield equal to two (2) in the SD field for extended squitters.* When the TCS subfield in the SD field is set equal to two (2), it shall signify the following:

- a) broadcast of the extended squitter surface formats, including the surface position message (3.1.2.8.6.4.3), the identification and category message (3.1.2.8.6.4.4), the aircraft operational status message (3.1.2.8.6.4.6) and the aircraft status message (3.1.2.8.6.4.6) for the next 60 seconds at the appropriate rates on the top antenna for aircraft systems having the antenna diversity capability, except if otherwise specified by SAS (3.1.2.6.1.4.1 f));
- b) inhibit replies to Mode A/C, Mode A/C/S all-call and Mode S-only all-call interrogations for the next 60 seconds;
- c) broadcast of acquisition squitters as per 3.1.2.8.5 using antenna as specified in 3.1.2.8.5.3 a);
- d) does not impact the air/ground state reported via the CA, FS and VS fields;
- e) discontinue broadcast of the extended squitter airborne message formats; and
- f) broadcast of the extended squitter surface formats at the rates according to the TRS subfield unless commanded to transmit at the rates set by the RCS subfield.

3.1.2.6.1.5 *PC and SD field processing.* When DI = 1, PC field processing shall be completed before processing the SD field.

3.1.2.6.2 *COMM-A ALTITUDE REQUEST, UPLINK FORMAT 20*

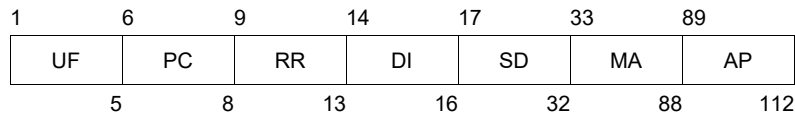

The format of this interrogation shall consist of these fields:

<i>Field</i>	<i>Reference</i>
UF uplink format	3.1.2.3.2.1.1
PC protocol	3.1.2.6.1.1
RR reply request	3.1.2.6.1.2
DI designator identification	3.1.2.6.1.3
SD special designator	3.1.2.6.1.4
MA message, Comm-A	3.1.2.6.2.1
AP address/parity	3.1.2.3.2.1.3

- 3.1.2.6.2.1 *MA: Message, Comm-A.* This 56-bit (33-88) field shall contain a data link message to the aircraft.

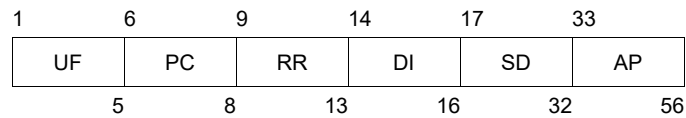
3.1.2.6.3 *SURVEILLANCE IDENTITY REQUEST, UPLINK FORMAT 5*

The format of this interrogation shall consist of these fields:

<i>Field</i>	<i>Reference</i>
UF uplink format	3.1.2.3.2.1.1
PC protocol	3.1.2.6.1.1
RR reply request	3.1.2.6.1.2
DI designator identification	3.1.2.6.1.3
SD special designator	3.1.2.6.1.4
AP address/parity	3.1.2.3.2.1.3

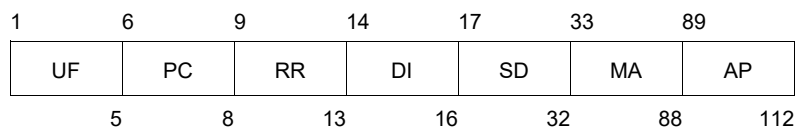
3.1.2.6.4 *COMM-A IDENTITY REQUEST, UPLINK FORMAT 2I*

The format of this interrogation shall consist of these fields:

<i>Field</i>	<i>Reference</i>
UF uplink format	3.1.2.3.2.1.1
PC protocol	3.1.2.6.1.1
RR reply request	3.1.2.6.1.2
DI designator identification	3.1.2.6.1.3
SD special designator	3.1.2.6.1.4
MA message, Comm-A	3.1.2.6.2.1
AP address/parity	3.1.2.3.2.1.3

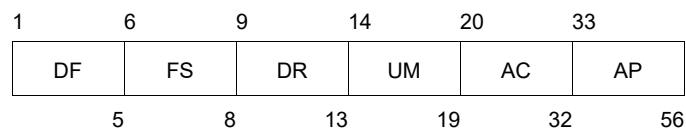
3.1.2.6.5 *SURVEILLANCE ALTITUDE REPLY, DOWNLINK FORMAT 4*

This reply shall be generated in response to an interrogation UF 4 or 20 with an RR field value less than 16. The format of this reply shall consist of these fields:

<i>Field</i>	<i>Reference</i>
DF downlink format	3.1.2.3.2.1.2
FS flight status	3.1.2.6.5.1
DR downlink request	3.1.2.6.5.2
UM utility message	3.1.2.6.5.3
AC altitude code	3.1.2.6.5.4
AP address/parity	3.1.2.3.2.1.3

3.1.2.6.5.1 *FS: Flight status.* This 3-bit (6-8) downlink field shall contain the following information:

Coding

- 0 signifies no alert and no SPI, aircraft is airborne
- 1 signifies no alert and no SPI, aircraft is on the ground
- 2 signifies alert, no SPI, aircraft is airborne
- 3 signifies alert, no SPI, aircraft is on the ground
- 4 signifies alert and SPI, aircraft is airborne or on the ground
- 5 signifies no alert and SPI, aircraft is airborne or on the ground
- 6 reserved
- 7 not assigned

Note.— *The conditions which cause an alert are given in 3.1.2.6.10.1.1.*

3.1.2.6.5.2 *DR: Downlink request.* This 5-bit (9-13) downlink field shall contain requests to downlink information.

Coding

- 0 signifies no downlink request
- 1 signifies request to send Comm-B message
- 2 reserved for ACAS
- 3 reserved for ACAS
- 4 signifies Comm-B broadcast message 1 available
- 5 signifies Comm-B broadcast message 2 available
- 6 reserved for ACAS
- 7 reserved for ACAS
- 8-15 not assigned
- 16-31 see downlink ELM protocol (3.1.2.7.7.1)

Codes 1-15 shall take precedence over codes 16-31.

Note.— *Giving precedence to codes 1-15 permits the announcement of a Comm-B message to interrupt the announcement of a downlink ELM. This gives priority to the announcement of the shorter message.*

3.1.2.6.5.3 *UM: Utility message.* This 6-bit (14-19) downlink field shall contain transponder communications status information as specified in 3.1.2.6.1.4.1 and 3.1.2.6.5.3.1.

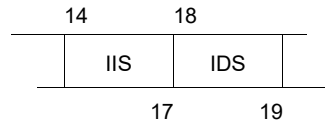
3.1.2.6.5.3.1 *Subfields in UM for multisite protocols**UM FIELD STRUCTURE*

The following subfields shall be inserted by the transponder into the UM field of the reply if a surveillance or Comm-A interrogation (UF equals 4, 5, 20, 21) contains DI = 1 and RSS other than 0:

- IIS: The 4-bit (14-17) interrogator identifier subfield reports the identifier of the interrogator that is reserved for multisite communications.
- IDS: The 2-bit (18, 19) identifier designator subfield reports the type of reservation made by the interrogator identified in IIS.

Assigned coding is:

- 0 signifies no information
- 1 signifies IIS contains Comm-B II code
- 2 signifies IIS contains Comm-C II code
- 3 signifies IIS contains Comm-D II code.

3.1.2.6.5.3.2 *Multisite reservation status.* The interrogator identifier of the ground station currently reserved for multisite Comm-B delivery (3.1.2.6.11.3.1) shall be transmitted in the IIS subfield together with code 1 in the IDS subfield if the UM content is not specified by the interrogation (when DI = 0 or 7, or when DI = 1 and RSS = 0).

The interrogator identifier of the ground station currently reserved for downlink ELM delivery (3.1.2.7.6.1), if any, shall be transmitted in the IIS subfield together with code 3 in the IDS subfield if the UM content is not specified by the interrogation and there is no current Comm-B reservation.

3.1.2.6.5.4 *AC: Altitude code.* This 13-bit (20-32) field shall contain altitude coded as follows:

- a) Bit 26 is designated as the M bit, and shall be 0 if the altitude is reported in feet. M equals 1 shall be reserved to indicate that the altitude reporting is in metric units.
- b) If M equals 0, then bit 28 is designated as the Q bit. Q equals 0 shall be used to indicate that the altitude is reported in 100-foot increments. Q equals 1 shall be used to indicate that the altitude is reported in 25-foot increments.
- c) If the M bit (bit 26) and the Q bit (bit 28) equal 0, the altitude shall be coded according to the pattern for Mode C replies of 3.1.1.7.12.2.3. Starting with bit 20 the sequence shall be C1, A1, C2, A2, C4, A4, ZERO, B1, ZERO, B2, D2, B4, D4.
- d) If the M bit equals 0 and the Q bit equals 1, the 11-bit field represented by bits 20 to 25, 27 and 29 to 32 shall represent a binary coded field with a least significant bit (LSB) of 25 ft. The binary value of the positive decimal integer “N” shall be encoded to report pressure-altitude in the range [(25 N – 1 000) plus or minus 12.5 ft]. The coding of 3.1.2.6.5.4 c) shall be used to report pressure-altitude above 50 187.5 ft.

Note 1.— This coding method is only able to provide values between minus 1 000 ft and plus 50 175 ft.

Note 2.— The most significant bit (MSB) of this field is bit 20 as required by 3.1.2.3.1.3.

- e) If the M bit equals 1, the 12-bit field represented by bits 20 to 25 and 27 to 31 shall be reserved for encoding altitude in metric units.
- f) 0 shall be transmitted in each of the 13 bits of the AC field if altitude information is not available or if the altitude has been determined invalid.

3.1.2.6.6 COMM-B ALTITUDE REPLY, DOWNLINK FORMAT 20

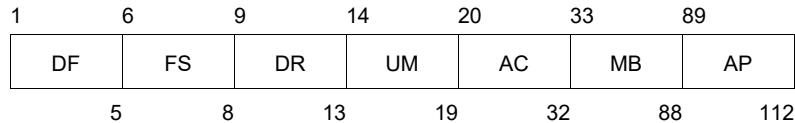

This reply shall be generated in response to an interrogation UF 4 or 20 with an RR field value greater than 15. The format of this reply shall consist of these fields:

<i>Field</i>	<i>Reference</i>
DF downlink format	3.1.2.3.2.1.2
FS flight status	3.1.2.6.5.1
DR downlink request	3.1.2.6.5.2
UM utility message	3.1.2.6.5.3
AC altitude code	3.1.2.6.5.4
MB message, Comm-B	3.1.2.6.6.1
AP address/parity	3.1.2.3.2.1.3

3.1.2.6.6.1 *MB: Message, Comm-B.* This 56-bit (33-88) downlink field shall be used to transmit data link messages to the ground.

3.1.2.6.7 SURVEILLANCE IDENTITY REPLY, DOWNLINK FORMAT 5

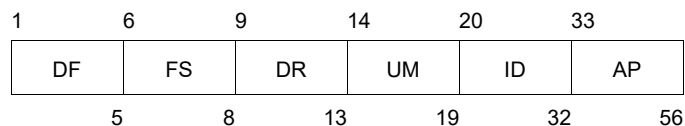

This reply shall be generated in response to an interrogation UF 5 or 21 with an RR field value less than 16. The format of this reply shall consist of these fields:

<i>Field</i>	<i>Reference</i>
DF downlink format	3.1.2.3.2.1.2
FS flight status	3.1.2.6.5.1
DR downlink request	3.1.2.6.5.2
UM utility message	3.1.2.6.5.3
ID identity	3.1.2.6.7.1
AP address/parity	3.1.2.3.2.1.3

3.1.2.6.7.1 *ID: Identity (Mode A code)*. This 13-bit (20-32) field shall contain aircraft identity code, in accordance with the pattern for Mode A replies in 3.1.1.6. Starting with bit 20, the sequence shall be C1, A1, C2, A2, C4, A4, ZERO, B1, D1, B2, D2, B4, D4.

3.1.2.6.8 *COMM-B IDENTITY REPLY, DOWNLINK FORMAT 21*

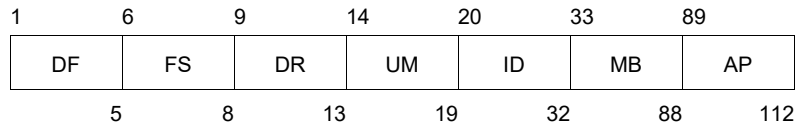

This reply shall be generated in response to an interrogation UF 5 or 21 with an RR field value greater than 15. The format of this reply shall consist of these fields:

<i>Field</i>	<i>Reference</i>
DF downlink format	3.1.2.3.2.1.2
FS flight status	3.1.2.6.5.1
DR downlink request	3.1.2.6.5.2
UM utility message	3.1.2.6.5.3
ID identity	3.1.2.6.7.1
MB message, Comm-B	3.1.2.6.6.1
AP address/parity	3.1.2.3.2.1.3

3.1.2.6.9 *LOCKOUT PROTOCOLS*

Note.— *Non-selective all-call lockout and multisite lockout are not mutually exclusive. Interrogators using multisite lockout protocols for interrogator networking coordination may use non-selective lockout commands in the same interrogation. For example, the non-selective lockout may be used to prevent Mode S transponder replies with DF=11 to wrongly detected Mode A/C/S all-call interrogations from Mode A/C-only all-call interrogations. This is because of the misinterpretation of the narrow P₄ pulse as a wide P₄ pulse.*

3.1.2.6.9.1 *Multisite all-call lockout*

Note.— *The multisite lockout protocol prevents transponder acquisition from being denied one ground station by lockout commands from an adjacent ground station that has overlapping coverage.*

3.1.2.6.9.1.1 The multisite lockout command shall be transmitted in the SD field (3.1.2.6.1.4.1). A lockout command for an II code shall be transmitted in an SD with DI = 1 or DI = 7. An II lockout command shall be indicated by LOS code equals 1 and the presence of a non-zero interrogator identifier in the IIS subfield of SD. A lockout command for an SI code shall be transmitted in an SD with DI = 3. SI lockout shall be indicated by LSS equals 1 and the presence of a non-zero interrogator identifier in the SIS subfield of SD. After a transponder has accepted an interrogation containing a multisite lockout command, that transponder shall commence to lock out (i.e. not accept) any Mode S-only all-call interrogation which includes the identifier of the interrogator that commanded the lockout. The lockout shall persist for an interval T_L (3.1.2.10.3.9) after the last acceptance of an interrogation containing the multisite lockout command. Multisite lockout shall not prevent acceptance of a Mode S-only all-call interrogation containing PR codes 8 to 12. If a lockout command (LOS = 1) is received together with IIS = 0, it shall be interpreted as a non-selective all-call lockout (3.1.2.6.9.2).

Note 1.— *Fifteen interrogators can send independent multisite II lockout commands. In addition, 63 interrogators can send independent SI lockout commands. Each of these lockout commands must be timed separately.*

Note 2.— Multisite lockout (which only uses non-zero II codes) does not affect the response of the transponder to Mode S-only all-call interrogations containing II equals 0 or to Mode A/C/S all-call interrogations.

3.1.2.6.9.2 Non-selective all-call lockout

Note 1.— In cases where the multisite lockout protocol for II codes is not required (e.g. there is no overlapping coverage or there is ground station coordination via ground-to-ground communications) the non-selective lockout protocol may be used.

On acceptance of an interrogation containing code 1 in the PC field, a transponder shall commence to lock out (i.e. not accept) two types of all-call interrogations:

- a) the Mode S-only all-call (UF = 11), with II equals 0; and
- b) the Mode A/C/S all-call of 3.1.2.1.5.1.1.

This lockout condition shall persist for an interval T_D (3.1.2.10.3.9) after the last receipt of the command. Non-selective lockout shall not prevent acceptance of a Mode S-only all-call interrogation containing PR codes 8 to 12.

Note 2.— Non-selective lockout does not affect the response of the transponder to Mode S-only all-call interrogations containing II not equal to 0.

3.1.2.6.10 BASIC DATA PROTOCOLS

3.1.2.6.10.1 *Flight status protocol.* Flight status shall be reported in the FS field (3.1.2.6.5.1).

3.1.2.6.10.1.1 *Alert.* An alert condition shall be reported in the FS field if the Mode A identity code transmitted in Mode A replies and in downlink formats DF equals 5 and DF equals 21 are changed by the pilot.

3.1.2.6.10.1.1.1 *Permanent alert condition.* The alert condition shall be maintained if the Mode A identity code is changed to 7500, 7600 or 7700.

3.1.2.6.10.1.1.2 *Temporary alert condition.* The alert condition shall be temporary and shall cancel itself after T_C seconds if the Mode A identity code is changed to a value other than those listed in 3.1.2.6.10.1.1.1. The T_C shall be retrigged and continued for T_C seconds after any change has been accepted by the transponder function.

Note 1.— This retrigging is performed to ensure that the ground interrogator obtains the desired Mode A identity code before the alert condition is cleared.

Note 2.— The value of T_C is given in 3.1.2.10.3.9.

3.1.2.6.10.1.1.3 *Termination of the permanent alert condition.* The permanent alert condition shall be terminated and replaced by a temporary alert condition when the Mode A identity code is set to a value other than 7500, 7600 or 7700.

3.1.2.6.10.1.2 *Ground report.* The on-the-ground status of the aircraft shall be reported in the CA field (3.1.2.5.2.2.1), the FS field (3.1.2.6.5.1), and the VS field (3.1.2.8.2.1). If an automatic indication of the on-the-ground condition (e.g., from a weight on wheels or strut switch) is available at the transponder data interface, it shall be used as the basis for the reporting of on-the-ground status except as specified in 3.1.2.6.10.3.1. If such indication is not available at the transponder data interface (3.1.2.10.5.1.3), the FS and VS codes shall indicate that the aircraft is airborne and the CA field shall indicate that the aircraft is either airborne or on the ground (CA = 6).

3.1.2.6.10.1.3 *Special position identification (SPI)*. An equivalent of the SPI pulse shall be transmitted by Mode S transponders in the FS field and the surveillance status subfield (SSS) when manually activated. This pulse shall be transmitted for T_I seconds after initiation (3.1.1.6.3, 3.1.1.7.13 and 3.1.2.8.6.3.1.1).

Note.— The value of T_I is given in 3.1.2.10.3.9.

3.1.2.6.10.2 *Capability reporting protocol*. The data structure and content of the data link capability report registers shall be implemented in such a way that interoperability is ensured.

Note 1.— Aircraft capability is reported in special fields as defined in the following paragraphs.

Note 2.— The data format of the registers for reporting capability is specified in the Technical Provisions for Mode S Services and Extended Squitter (Doc 9871).

3.1.2.6.10.2.1 *Capability report*. The 3-bit CA field, contained in the all-call reply, DF equals 11, shall report the basic capability of the Mode S transponder as described in 3.1.2.5.2.2.1.

3.1.2.6.10.2.2 *Data link capability report*. The data link capability report shall provide the interrogator with a description of the data link capability of the Mode S installation.

Note.— The data link capability report is contained in register 10_{16} with a possible extension in registers 11_{16} to 16_{16} when any continuation will be required.

3.1.2.6.10.2.2.1 *Extraction and subfields in MB for data link capability report*

3.1.2.6.10.2.2.1.1 *Extraction of the data link capability report contained in register 10_{16}* . The report shall be obtained by a ground-initiated Comm-B reply in response to an interrogation containing RR equals 17 and DI is not equal to 7 or DI equals 7 and RRS equals 0 (3.1.2.6.11.2).

3.1.2.6.10.2.2.1.2 *Sources of data link capability*. Data link capability reports shall contain the capabilities provided by the transponder, the ADLP and the ACAS unit. If external inputs are lost, the transponder shall zero the corresponding bits in the data link report.

3.1.2.6.10.2.2.1.3 The data link capability report shall contain information on the following capabilities as specified in Table 3-6.

3.1.2.6.10.2.2.1.4 The Mode S subnetwork version number shall contain information to ensure interoperability with older airborne equipment.

3.1.2.6.10.2.2.1.4.1 The Mode S subnetwork version number shall indicate that all implemented subnetwork functions are in compliance with the requirements of the indicated version number. The Mode S subnetwork version number shall be set to a non-zero value if at least one DTE or Mode S specific service is installed.

Note.— The version number does not indicate that all possible functions of that version are implemented.

3.1.2.6.10.2.2.2 *Updating of the data link capability report*. The transponder shall, at intervals not exceeding four seconds, compare the current data link capability status (bits 41-88 in the data link capability report) with that last reported and shall, if a difference is noted, initiate a revised data link capability report by Comm-B broadcast (3.1.2.6.11.4) for BDS1 = 1 (33-36) and BDS 2 = 0 (37-40). The transponder shall initiate, generate and announce the revised capability report even if the aircraft data link capability is degraded or lost. The transponder shall ensure that the BDS code is set for the data link capability report in all cases, including a loss of the interface.

Note.— The setting of the BDS code by the transponder ensures that a broadcast change of capability report will contain the BDS code for all cases of data link failure (e.g. the loss of the transponder data link interface).

3.1.2.6.10.2.2.3 Zeroing of bits in the data link capability report

If capability information to the transponder fails to provide an update at a rate of at least once every 4 seconds, the transponder shall insert ZERO in bits 41 to 56 of the data link capability report (transponder register 10₁₆).

Note.— Bits 1 to 8 contain the BDS1 and BDS2 codes. Bits 16 and 37 to 40 contain ACAS capability information. Bit 33 indicates the availability of aircraft identification data and is set by the transponder when the data comes from a separate interface and not from the ADLP. Bit 35 is the SI code indication. All of these bits are inserted by the transponder.

3.1.2.6.10.2.3 *Common usage GICB capability report.* Common usage GICB services which are being actively updated shall be indicated in transponder register 17₁₆.

3.1.2.6.10.2.4 *Mode S specific services GICB capability reports.* GICB services that are installed shall be reported in registers 18₁₆ to 1C₁₆.

3.1.2.6.10.2.5 *Mode S specific services MSP capability reports.* MSP services that are installed shall be reported in registers 1D₁₆ to 1F₁₆.

3.1.2.6.10.3 Validation of on-the-ground status declared by an automatic means

Note.— For aircraft with an automatic means of determining vertical status, the CA field reports whether the aircraft is airborne or on the ground. ACAS II acquires aircraft using the short or extended squitter, both of which contain the CA field. If an aircraft reports on-the-ground status, that aircraft will not be interrogated by ACAS II in order to reduce unnecessary interrogation activity. If the aircraft is equipped to report extended squitter messages, the function that formats these messages may have information available to validate that an aircraft reporting “on-the-ground” is actually airborne.

3.1.2.6.10.3.1 Aircraft with an automatic means for determining the on-the-ground state on which transponders have access to at least one of the parameters, ground speed, radio altitude or airspeed, shall perform the following validation check:

If the automatically determined air/ground status is not available or is “airborne”, no validation shall be performed. If the automatically determined air/ground status is available and “on-the-ground” condition is being reported, the air/ground status shall be overridden and changed to “airborne” if:

Ground Speed > 100 knots OR Airspeed > 100 knots OR Radio Altitude > 50 feet

3.1.2.6.11 STANDARD LENGTH COMMUNICATIONS PROTOCOLS

Note 1.— The two types of standard length communications protocols are Comm-A and Comm-B; messages using these protocols are transferred under the control of the interrogator. Comm-A messages are sent directly to the transponder and are completed within one transaction. A Comm-B message is used to transfer information from air to ground and can be initiated either by the interrogator or the transponder. In the case of ground-initiated Comm-B transfers, the interrogator requests data to be read out from the transponder, which delivers the message in the same transaction. In the case of air-initiated Comm-B transfers, the transponder announces the intention to transmit a message; in a subsequent transaction an interrogator will extract the message.

Note 2.— In a non-selective air-initiated Comm-B protocol all transactions necessary can be controlled by any interrogator.

Note 3.— In some areas of overlapping interrogator coverage there may be no means for coordinating interrogator activities via ground communications. Air-initiated Comm-B communications protocols require more than one transaction for completion. Provision is made to ensure that a Comm-B message is closed out only by the interrogator that actually transferred the message. This can be accomplished through the use of the multisite Comm-B communications protocols or through the use of the enhanced Comm-B communications protocols.

Note 4.— The multisite and the non-selective communications protocols cannot be used simultaneously in a region of overlapping interrogator coverage unless the interrogators coordinate their communications activities via ground communications.

Note 5.— The multisite communications protocol is independent of the multisite lockout protocol. That is, the multisite communications protocol may be used with the non-selective lockout protocol and vice versa. The choice of lockout and communications protocols to be used depends upon the network management technique being used.

Note 6.— The broadcast Comm-B protocol can be used to make a message available to all active interrogators.

3.1.2.6.11.1 *Comm-A.* The interrogator shall deliver a Comm-A message in the MA field of an interrogation UF = 20 or 21.

3.1.2.6.11.1.1 *Comm-A technical acknowledgement.* Acceptance of a Comm-A interrogation shall be automatically technically acknowledged by the transponder, by the transmission of the requested reply (3.1.2.10.5.2.2.1).

Note.— The receipt of a reply from the transponder according to the rules of 3.1.2.4.1.2.3 d) and 3.1.2.4.1.3.2.2.2 is the acknowledgement to the interrogator that the interrogation has been accepted by the transponder. If either uplink or downlink fail, this reply will be missing and the interrogator will normally send the message again. In the case of downlink failure, the transponder may receive the message more than once.

3.1.2.6.11.1.2 *Comm-A broadcast.* If a Comm-A broadcast interrogation is accepted (3.1.2.4.1.2.3.1.3) information transfer shall be handled according to 3.1.2.10.5.2.1.1 but other transponder functions shall not be affected and a reply shall not be transmitted.

Note 1.— There is no technical acknowledgement to a Comm-A broadcast message.

Note 2.— Since the transponder does not process the control fields of a Comm-A broadcast interrogation, the 27 bits following the UF field are also available for user data.

3.1.2.6.11.2 *Ground-initiated Comm-B*

3.1.2.6.11.2.1 *Comm-B data selector, BDS.* The 8-bit BDS code shall determine the register whose contents shall be transferred in the MB field of the Comm-B reply. It shall be expressed in two groups of 4 bits each, BDS1 (most significant 4 bits) and BDS2 (least significant 4 bits).

Note.— The transponder register allocation is specified in Annex 10, Volume III, Part I, Chapter 5, Table 5-24.

3.1.2.6.11.2.2 *BDS1 code.* The BDS1 code shall be as defined in the RR field of a surveillance or Comm-A interrogation.

3.1.2.6.11.2.3 *BDS2 code.* The BDS2 code shall be as defined in the RRS subfield of the SD field (3.1.2.6.1.4.1) when DI = 7 or DI = 3. If no BDS2 code is specified (i.e. DI is not equal to either 7 or 3) it shall signify that BDS2 = 0.

3.1.2.6.11.2.4 *Protocol.* On receipt of such a request, the MB field of the reply shall contain the contents of the requested ground-initiated Comm-B register.

3.1.2.6.11.2.4.1 If the requested register is not serviced by the aircraft installation, the transponder shall reply and the MB field of the reply shall contain all ZEROs.

3.1.2.6.11.2.5 *Overlay control.* If the “DI” code of the Comm-B requesting interrogation is 0, 3 or 7, the “SD” contains the overlay control (OVC) field in accordance with paragraph 3.1.2.6.1.4.1 i).

- a) If the “OVC” is equal to “1,” then the reply to the interrogation shall contain the “DP” (data parity) field in accordance with paragraph 3.1.2.3.2.1.5; and
- b) If the “OVC” is equal to “0,” then the reply to the interrogation shall contain the “AP” field in accordance with paragraph 3.1.2.3.2.1.3.

3.1.2.6.11.3 *Air-initiated Comm-B*

3.1.2.6.11.3.1 *General protocol.* The transponder shall announce the presence of an air-initiated Comm-B message with the insertion of code 1 in the DR field. To extract an air-initiated Comm-B message, the interrogator shall transmit a request for a Comm-B message reply in a subsequent interrogation with RR equal to 16 and, if DI equals 7, RRS must be equal to 0 (3.1.2.6.11.3.2.1 and 3.1.2.6.11.3.3.1). Receipt of this request code shall cause the transponder to transmit the air-initiated Comm-B message. If a command to transmit an air-initiated Comm-B message is received while no message is waiting to be transmitted, the reply shall contain all ZEROs in the MB field.

The reply that delivers the message shall continue to contain code 1 in the DR field. After a Comm-B closeout has been accomplished, the message shall be cancelled and the DR code belonging to this message immediately removed. If another air-initiated Comm-B message is waiting to be transmitted, the transponder shall set the DR code to 1, so that the reply contains the announcement of this next message.

Note.— The announcement and cancellation protocol ensures that an air-initiated message will not be lost due to uplink or downlink failures that occur during the delivery process.

3.1.2.6.11.3.2 *Additional protocol for multisite air-initiated Comm-B*

Note.— The announcement of an air-initiated Comm-B message waiting to be delivered may be accompanied by a multisite reservation status report in the UM field (3.1.2.6.5.3.2).

Recommendation.— *An interrogator should not attempt to extract a message if it has determined that it is not the reserved site.*

3.1.2.6.11.3.2.1 *Message transfer.* An interrogator shall request a Comm-B reservation and extract an air-initiated Comm-B message by transmitting a surveillance or Comm-A interrogation UF equals 4, 5, 20 or 21 containing:

RR = 16
 DI = 1
 IIS = assigned interrogator identifier
 MBS = 1 (Comm-B reservation request)

Note.— A Comm-B multisite reservation request is normally accompanied by a Comm-B reservation status request (RSS = 1). This causes the interrogator identifier of the reserved site to be inserted in the UM field of the reply.

3.1.2.6.11.3.2.1.1 Protocol procedure in response to this interrogation shall depend upon the state of the B-timer which indicates if a Comm-B reservation is active. This timer shall run for T_R seconds.

Note 1.— The value of T_R is given in 3.1.2.10.3.9.

- a) If the B-timer is not running, the transponder shall grant a reservation to the requesting interrogator by:
 - 1) storing the IIS of the interrogation as the Comm-B II; and
 - 2) starting the B-timer.

A multisite Comm-B reservation shall not be granted by the transponder unless an air-initiated Comm-B message is waiting to be transmitted and the requesting interrogation contains RR equals 16, DI equals 1, MBS equals 1 and IIS is not 0.

- b) If the B-timer is running and the IIS of the interrogation equals the Comm-B II, the transponder shall restart the B-timer.
- c) If the B-timer is running and the IIS of the interrogation does not equal the Comm-B II, then there shall be no change to the Comm-B II or the B-timer.

Note 2.— In case c) the reservation request has been denied.

3.1.2.6.11.3.2.1.2 In each case the transponder shall reply with the Comm-B message in the MB field.

3.1.2.6.11.3.2.1.3 An interrogator shall determine if it is the reserved site for this message through coding in the UM field. If it is the reserved site it shall attempt to close out the message in a subsequent interrogation. If it is not the reserved site it shall not attempt to close out the message.

3.1.2.6.11.3.2.2 *Multisite-directed Comm-B transmissions.* To direct an air-initiated Comm-B message to a specific interrogator, the multisite Comm-B protocol shall be used. When the B-timer is not running, the interrogator identifier of the desired destination shall be stored as the Comm-B II. Simultaneously the B-timer shall be started and the DR code shall be set to 1. For a multisite-directed Comm-B message, the B-timer shall not automatically time out but shall continue to run until:

- a) the message is read and closed out by the reserved site; or
- b) the message is cancelled (3.1.2.10.5.4) by the data link avionics.

Note.— The protocols of 3.1.2.6.5.3 and 3.1.2.6.11.3.2.1 will then result in delivery of the message to the reserved site. The data link avionics may cancel the message if delivery to the reserved site cannot be accomplished.

3.1.2.6.11.3.2.3 *Multisite Comm-B closeout.* The interrogator shall close out a multisite air-initiated Comm-B by transmitting either a surveillance or a Comm-A interrogation containing:

either DI = 1
 IIS = assigned interrogator identifier
 MBS = 2 (Comm-B closeout)

or DI = 0, 1 or 7
 IIS = assigned interrogator identifier
 PC = 4 (Comm-B closeout)

The transponder shall compare the IIS of the interrogation to the Comm-B II and if the interrogator identifiers do not match, the message shall not be cleared and the status of the Comm-B II, B-timer, and DR code shall not be changed. If the interrogator identifiers match, the transponder shall set the Comm-B II to 0, reset the B-timer, clear the DR code for this message and clear the message itself. The transponder shall not close out a multisite air-initiated Comm-B message unless it has been read out at least once by the reserved site.

3.1.2.6.11.3.2.4 *Automatic expiration of Comm-B reservation.* If the B-timer period expires before a multisite closeout has been accomplished, the Comm-B II shall be set to 0 and the B-timer reset. The Comm-B message and the DR field shall not be cleared by the transponder.

Note.— *This makes it possible for another site to read and clear this message.*

3.1.2.6.11.3.3 *Additional protocol for non-selective air-initiated Comm-B*

Note.— *In cases where the multisite protocols are not required (i.e. no overlapping coverage or sensor coordination via ground-to-ground communication), the non-selective air-initiated Comm-B protocol may be used.*

3.1.2.6.11.3.3.1 *Message transfer.* The interrogator shall extract the message by transmitting either RR equals 16 and DI is not equal to 7, or RR equals 16, DI equals 7 and RRS equals 0 in a surveillance or Comm-A interrogation.

3.1.2.6.11.3.3.2 *Comm-B closeout.* The interrogator shall close out a non-selective air-initiated Comm-B message by transmitting PC equals 4 (Comm-B closeout). On receipt of this command, the transponder shall perform closeout, unless the B-timer is running. If the B-timer is running, indicating that a multisite reservation is in effect, closeout shall be accomplished as per 3.1.2.6.11.3.2.3. The transponder shall not close out a non-selective air-initiated Comm-B message unless it has been read out at least once by an interrogation using non-selective protocols.

3.1.2.6.11.3.4 *Enhanced air-initiated Comm-B protocol*

Note.— *The enhanced air-initiated Comm-B protocol provides a higher data link capacity by permitting parallel delivery of air-initiated Comm-B messages by up to sixteen interrogators, one for each II code. Operation without the need for multisite Comm-B reservations is possible in regions of overlapping coverage for interrogators equipped for the enhanced air-initiated Comm-B protocol. The protocol is fully conformant to the standard multisite protocol and thus is compatible with interrogators that are not equipped for the enhanced protocol.*

3.1.2.6.11.3.4.1 The transponder shall be capable of storing each of the sixteen II codes: (1) an air-initiated or multisite-directed Comm-B message and (2) the contents of GICB registers 2 through 4.

Note.— *GICB registers 2 through 4 are used for the Comm-B linking protocol defined in the Mode S subnetwork SARPs (Annex 10, Volume III, Part I, Chapter 5).*

3.1.2.6.11.3.4.2 *Enhanced multisite air-initiated Comm-B protocol*

3.1.2.6.11.3.4.2.1 *Initiation.* An air-initiated Comm-B message input into the transponder shall be stored in the registers assigned to II = 0.

3.1.2.6.11.3.4.2.2 *Announcement and extraction.* A waiting air-initiated Comm-B message shall be announced in the DR field of the replies to all interrogators for which a multisite directed Comm-B message is not waiting. The UM field of the announcement reply shall indicate that the message is not reserved for any II code, i.e. the IIS subfield shall be set to 0. When a command to read this message is received from a given interrogator, the reply containing the message shall contain an IIS subfield content indicating that the message is reserved for the II code contained in the interrogation from that interrogator. After readout and until closeout, the message shall continue to be assigned to that II code. Once a message is assigned to a specific II code, announcement of this message shall be no longer made in the replies to interrogators with other II codes. If the message is not closed out by the assigned interrogator for the period of the B-timer, the message shall revert back to multisite air-initiated status and the process shall repeat. Only one multisite air-initiated Comm-B message shall be in process at a time.

3.1.2.6.11.3.4.2.3 *Closeout.* A closeout for a multisite air-initiated message shall only be accepted from the interrogator that is currently assigned to transfer the message.

3.1.2.6.11.3.4.2.4 *Announcement of the next message waiting.* The DR field shall indicate a message waiting in the reply to an interrogation containing a Comm-B closeout if an unassigned air-initiated message is waiting and has not been assigned to a II code, or if a multisite-directed message is waiting for that II code (3.1.2.6.11.3.4.3).

3.1.2.6.11.3.4.3 *Enhanced multisite directed Comm-B protocol*

3.1.2.6.11.3.4.3.1 *Initiation.* When a multisite directed message is input into the transponder, it shall be placed in the Comm-B registers assigned to the II code specified for the message. If the registers for this II code are already occupied, (i.e. a multisite directed message is already in process to this II code) the new message shall be queued until the current transaction with that II code is closed out.

3.1.2.6.11.3.4.3.2 *Announcement.* Announcement of a Comm-B message waiting transfer shall be made using the DR field as specified in 3.1.2.6.5.2 with the destination interrogator II code contained in the IIS subfield as specified in 3.1.2.6.5.3.2. The DR field and IIS subfield contents shall be set specifically for the interrogator that is to receive the reply. A waiting multisite directed message shall only be announced in the replies to the intended interrogator. It shall not be announced in the replies to other interrogators.

Note 1.— If a multisite-directed message is waiting for II = 2, the surveillance replies to that interrogator will contain DR = 1 and IIS = 2. If this is the only message in process, replies to all other interrogators will indicate that no message is waiting.

Note 2.— In addition to permitting parallel operation, this form of announcement enables a greater degree of announcement of downlink ELMs. The announcements for the downlink ELM and the Comm-B share the DR field. Only one announcement can take place at a time due to coding limitations. In case both a Comm-B and a downlink ELM are waiting, announcement preference is given to the Comm-B. In the example above, if an air-directed Comm-B was waiting for II = 2 and a multisite-directed downlink ELM was waiting for II = 6, both interrogators would see their respective announcements on the first scan since there would be no Comm-B announcement to II = 6 to block the announcement of the waiting downlink ELM.

3.1.2.6.11.3.4.3.3 *Closeout.* Closeout shall be accomplished as specified in 3.1.2.6.11.3.2.3.

3.1.2.6.11.3.4.3.4 *Announcement of the next message waiting.* The DR field shall indicate a message waiting in the reply to an interrogation containing a Comm-B closeout if another multisite directed message is waiting for that II code, or if an air-initiated message is waiting and has not been assigned to a II code. (See 3.1.2.6.11.3.4.2.4.)

3.1.2.6.11.3.4.4 *Enhanced non-selective Comm-B protocol.* The availability of a non-selective Comm-B message shall be announced to all interrogators. Otherwise, the protocol shall be as specified in 3.1.2.6.11.3.3.

3.1.2.6.11.4 *Comm-B broadcast*

Note 1.— A Comm-B message may be broadcast to all active interrogators within range. Messages are alternately numbered 1 and 2 and are self-cancelling after 18 seconds. Interrogators have no means to cancel Comm-B broadcast messages.

Note 2.— Use of the Comm-B broadcast is restricted to transmission of information which does not require a subsequent ground-initiated uplink response.

Note 3.— The timer used for the Comm-B broadcast cycle is the same as that used for the Comm-B multisite protocol.

Note 4.— Data formats for Comm-B broadcast are specified in the Technical Provisions for Mode S Services and Extended Squitter (Doc 9871).

3.1.2.6.11.4.1 Initiation

3.1.2.6.11.4.1.1 A Comm-B broadcast cycle shall begin with:

- a) the loading of the broadcast message into the Comm-B buffer;
- b) the starting of the B-timer for the current Comm-B message; and

Note.— If there is more than one Comm-B message waiting for transmission, the timer is only started once the message becomes the current Comm-B broadcast.

- c) the selection of DR code 4 or 5 (see 3.1.2.6.5.2), for insertion into future replies with DF 4, 5, 20 or 21 when ACAS information is not available, or DR code 6 or 7 when ACAS information is available.

3.1.2.6.11.4.1.2 The DR field shall be changed to the next value each time a new Comm-B broadcast message is initiated by the transponder.

Note.— The change of the DR value is used by the interrogator to detect that a new Comm-B broadcast message is announced and to extract the new Comm-B message.

3.1.2.6.11.4.1.3 A Comm-B broadcast cycle shall not be initiated when an air-initiated Comm-B message is waiting to be transmitted.

3.1.2.6.11.4.1.4 A new Comm-B broadcast cycle shall not interrupt a current Comm-B broadcast cycle.

3.1.2.6.11.4.2 *Extraction.* To extract the broadcast message, an interrogator shall transmit RR equals 16 and DI not equal to 3 or 7 or RR equals 16 and DI equals 3 or 7 with RRS equals 0 in a subsequent interrogation.

3.1.2.6.11.4.3 *Expiration.* When the B-timer period expires, the transponder shall clear the DR code for this message, discard the present broadcast message and change the broadcast message number (from 1 to 2 or 2 to 1) in preparation for a subsequent Comm-B broadcast.

3.1.2.6.11.4.4 *Interruption.* In order to prevent a Comm-B broadcast cycle from delaying the delivery of an air-initiated Comm-B message, provision shall be made for an air-initiated Comm-B to interrupt a Comm-B broadcast cycle. If a broadcast cycle is interrupted, the B-timer shall be reset, the interrupted broadcast message shall be retained and the message number shall not be changed. Delivery of the interrupted broadcast message shall recommence when no air-initiated Comm-B transaction is in effect. The message shall then be broadcast for the full duration of the B-timer.

3.1.2.6.11.4.5 *Enhanced broadcast Comm-B protocol.* A broadcast Comm-B message shall be announced to all interrogators using II codes. The message shall remain active for the period of the B-timer for each II code. The provision for interruption of a broadcast by non-broadcast Comm-B as specified in 3.1.2.6.11.4.4 shall apply separately to each II code. When the B-timer period has been achieved for all II codes, the broadcast message shall be automatically cleared as specified in 3.1.2.6.11.4.3. A new broadcast message shall not be initiated until the current broadcast has been cleared.

Note.— Due to the fact that broadcast message interruption occurs independently for each II code, it is possible that the broadcast message timeout will occur at different times for different II codes.

3.1.2.6.11.4.6 *Management of Comm-B messages waiting for transmission.* If the content of a waiting Comm-B broadcast message is updated, only the most recent value for each downlink broadcast identifier shall be retained and broadcast once the current Comm-B broadcast is finished.

Note.— Downlink broadcast identifiers are defined in the Technical Provisions for Mode S Services and Extended Squitter (Doc 9871).

3.1.2.7 EXTENDED LENGTH COMMUNICATION TRANSACTIONS

Note 1.— Long messages, either on the uplink or the downlink, can be transferred by the extended length message (ELM) protocols through the use of Comm-C (UF = 24) and Comm-D (DF = 24) formats respectively. The ELM uplink protocol provides for the transmission on the uplink of up to sixteen 80-bit message segments before requiring a reply from the transponder. They also allow a corresponding procedure on the downlink.

Note 2.— In some areas of overlapping interrogator coverage there may be no means for coordinating interrogator activities via ground communications. However, the ELM communication protocols require more than one transaction for completion; coordination is thus necessary to ensure that segments from different messages are not interleaved and that transactions are not inadvertently closed out by the wrong interrogator. This can be accomplished through the use of the multisite communications protocols or through the use of the enhanced ELM protocols.

Note 3.— Downlink extended length messages are transmitted only after authorization by the interrogator. The segments to be transmitted are contained in Comm-D replies. As with air-initiated Comm-B messages, downlink ELMs are either announced to all interrogators or directed to a specific interrogator. In the former case an individual interrogator can use the multisite protocol to reserve for itself the ability to close out the downlink ELM transaction. A transponder can be instructed to identify the interrogator that has reserved the transponder for an ELM transaction. Only that interrogator can close out the ELM transaction and reservation.

Note 4.— The multisite protocol and the non-selective protocol cannot be used simultaneously in a region of overlapping interrogator coverage unless the interrogators coordinate their communications activities via ground communications.

3.1.2.7.1 COMM-C, UPLINK FORMAT 24

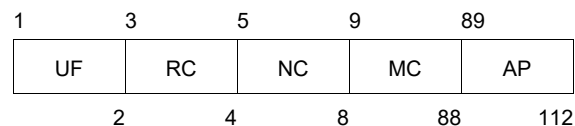

The format of this interrogation shall consist of these fields:

<i>Field</i>	<i>Reference</i>
UF uplink format	3.1.2.3.2.1.1
RC reply control	3.1.2.7.1.1
NC number of C-segment	3.1.2.7.1.2
MC message, Comm-C	3.1.2.7.1.3
AP address/parity	3.1.2.3.2.1.3

3.1.2.7.1.1 *RC: Reply control.* This 2-bit (3-4) uplink field shall designate segment significance and reply decision.

Coding

- RC = 0 signifies uplink ELM initial segment in MC
 = 1 signifies uplink ELM intermediate segment in MC
 = 2 signifies uplink ELM final segment in MC
 = 3 signifies a request for downlink ELM delivery (3.1.2.7.7.2)

3.1.2.7.1.2 *NC: Number of C-segment.* This 4-bit (5-8) uplink field shall designate the number of the message segment contained in MC (3.1.2.7.4.2.1). NC shall be coded as a binary number.

3.1.2.7.1.3 *MC: Message, Comm-C.* This 80-bit (9-88) uplink field shall contain:

- a) one of the segments of a sequence used to transmit an uplink ELM to the transponder containing the 4-bit (9-12) IIS subfield; or
- b) control codes for a downlink ELM, the 16-bit (9-24) SRS subfield (3.1.2.7.7.2.1) and the 4-bit (25-28) IIS subfield.

Note.— *Message content and codes are not included in this chapter except for 3.1.2.7.7.2.1.*

3.1.2.7.2 *INTERROGATION-REPLY PROTOCOL FOR UF24*

Note.— *Interrogation-reply coordination for the above format follows the protocol outlined in Table 3-5 (3.1.2.4.1.3.2.2).*

THIS PAGE INTENTIONALLY LEFT BLANK

3.1.2.7.3 COMM-D, DOWNLINK FORMAT 24

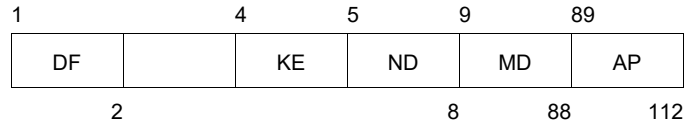

The format of this reply shall consist of these fields:

<i>Field</i>	<i>Reference</i>
DF downlink format spare — 1 bit	3.1.2.3.2.1.2
KE control, ELM	3.1.2.7.3.1
ND number of D-segment	3.1.2.7.3.2
MD message, Comm-D	3.1.2.7.3.3
AP address/parity	3.1.2.3.2.1.3

3.1.2.7.3.1 *KE: Control, ELM.* This 1-bit (4) downlink field shall define the content of the ND and MD fields.

Coding

KE = 0 signifies downlink ELM transmission
 1 signifies uplink ELM acknowledgement

3.1.2.7.3.2 *ND: Number of D-segment.* This 4-bit (5-8) downlink field shall designate the number of the message segment contained in MD (3.1.2.7.7.2). ND shall be coded as a binary number.

3.1.2.7.3.3 *MD: Message, Comm-D.* This 80-bit (9-88) downlink field shall contain:

- a) one of the segments of a sequence used to transmit a downlink ELM to the interrogator; or
- b) control codes for an uplink ELM.

3.1.2.7.4 MULTISITE UPLINK ELM PROTOCOL

3.1.2.7.4.1 *Multisite uplink ELM reservation.* An interrogator shall request a reservation for an uplink ELM by transmitting a surveillance or Comm-A interrogation containing:

DI = 1
 IIS = assigned interrogator identifier
 MES = 1 or 5 (uplink ELM reservation request)

Note.— A multisite uplink ELM reservation request is normally accompanied by an uplink ELM reservation status request (RSS = 2). This causes the interrogator identifier of the reserved site to be inserted in the UM field of the reply.

3.1.2.7.4.1.1 Protocol procedure in response to this interrogation shall depend upon the state of the C-timer which indicates if an uplink ELM reservation is active. This timer shall run for T_R seconds.

Note 1.— The value of T_R is given in 3.1.2.10.3.9.

- a) If the C-timer is not running, the transponder shall grant a reservation to the requesting interrogator by:

- 1) storing the IIS of the interrogation as the Comm-C II and,
 - 2) starting the C-timer.
- b) If the C-timer is running and the IIS of the interrogation equals the Comm-C II, the transponder shall restart the C-timer.
 - c) If the C-timer is running and the IIS of the interrogation does not equal the Comm-C II, there shall be no change to the Comm-C II or the C-timer.

Note 2.— In case c) the reservation request has been denied.

3.1.2.7.4.1.2 An interrogator shall not start ELM activity unless, during the same scan, having requested an uplink ELM status report, it has received its own interrogator identifier as the reserved interrogator for uplink ELM in the UM field.

Note.— If ELM activity is not started during the same scan as the reservation, a new reservation request may be made during the next scan.

3.1.2.7.4.1.3 If uplink ELM delivery is not completed on the current scan, the interrogator shall ensure that it still has a reservation before delivering additional segments on a subsequent scan.

3.1.2.7.4.2 *Multisite uplink ELM delivery.* The minimum length of an uplink ELM shall be 2 segments, the maximum length shall be 16 segments.

3.1.2.7.4.2.1 *Initial segment transfer.* The interrogator shall begin the ELM uplink delivery for an n-segment message (NC values from 0 to n-1) by a Comm-C transmission containing RC equals 0. The message segment transmitted in the MC field shall be the last segment of the message and shall carry NC equals n-1.

On receipt of an initializing segment (RC = 0) the transponder shall establish a “setup” defined as:

- a) clearing the number and content of previous segment storage registers and the associated TAS field;
- b) assigning storage space for the number of segments announced in NC of this interrogation; and
- c) storing the MC field of the segment received.

The transponder shall not reply to this interrogation.

Receipt of another initializing segment shall result in a new setup within the transponder.

3.1.2.7.4.2.2 *Transmission acknowledgement.* The transponder shall use the TAS subfield to report the segments received so far in an uplink ELM sequence. The information contained in the TAS subfield shall be continually updated by the transponder as segments are received.

Note.— Segments lost in uplink transmission are noted by their absence in the TAS report and are retransmitted by the interrogator which will then send further final segments to assess the extent of message completion.

3.1.2.7.4.2.2.1 *TAS, transmission acknowledgement subfield in MD.* This 16-bit (17-32) downlink subfield in MD reports the segment numbers received so far in an uplink ELM sequence. Starting with bit 17, which denotes segment number 0, each of the following bits shall be set to ONE if the corresponding segment of the sequence has been received. TAS shall appear in MD if KE equals 1 in the same reply.

3.1.2.7.4.2.3 *Intermediate segment transfer.* The interrogator shall transfer intermediate segments by transmitting Comm-C interrogations with RC equals 1. The transponder shall store the segments and update TAS only if the setup of 3.1.2.7.4.2.1 is in effect and if the received NC is smaller than the value stored at receipt of the initial segment. No reply shall be generated on receipt of an intermediate segment.

Note.— *Intermediate segments may be transmitted in any order.*

3.1.2.7.4.2.4 *Final segment transfer.* The interrogator shall transfer a final segment by transmitting a Comm-C interrogation with RC equals 2. The transponder shall store the content of the MC field and update TAS if the setup of 3.1.2.7.4.2.1 is in effect and if the received NC is smaller than the value of the initial segment NC. The transponder shall reply under all circumstances as per 3.1.2.7.4.2.5.

Note 1.— *This final segment transfer interrogation can contain any message segment.*

Note 2.— *RC equals 2 is transmitted any time that the interrogator wants to receive the TAS subfield in the reply. Therefore, more than one “final” segment may be transferred during the delivery of an uplink ELM.*

3.1.2.7.4.2.5 *Acknowledgement reply.* On receipt of a final segment, the transponder shall transmit a Comm-D reply (DF = 24), with KE equals 1 and with the TAS subfield in the MD field. This reply shall be transmitted at 128 microseconds plus or minus 0.25 microsecond following the sync phase reversal of the interrogation delivering the final segment.

3.1.2.7.4.2.6 *Completed message.* The transponder shall deem the message complete if all segments announced by NC in the initializing segment have been received. If the message is complete, the message content shall be delivered to the outside via the ELM interface of 3.1.2.10.5.2.1.3 and cleared. No later-arriving segments shall be stored. The TAS content shall remain unchanged until either a new setup is called for (3.1.2.7.4.2.1) or until closeout (3.1.2.7.4.2.8).

3.1.2.7.4.2.7 *C-timer restart.* The C-timer shall be restarted each time that a received segment is stored and the Comm-C II is not 0.

Note.— *The requirement for the Comm-C II to be non-zero prevents the C-timer from being restarted during a non-selective uplink ELM transaction.*

3.1.2.7.4.2.8 *Multisite uplink ELM closeout.* The interrogator shall close out a multisite uplink ELM by transmitting either a surveillance or a Comm-A interrogation containing:

either DI = 1
 IIS = assigned interrogator identifier
 MES = 2, 6 or 7 (uplink ELM closeout)

or DI = 0, 1 or 7
 IIS = assigned interrogator identifier
 PC = 5 (uplink ELM closeout)

The transponder shall compare the IIS of the interrogation to the Comm-C II and if the interrogator identifiers do not match, the state of the ELM uplink process shall not be changed.

If the interrogator identifiers match, the transponder shall set the Comm-C II to 0, reset the C-timer, clear the stored TAS and discard any stored segments of an incomplete message.

3.1.2.7.4.2.9 *Automatic multisite uplink ELM closeout.* If the C-timer period expires before a multisite closeout has been accomplished the closeout actions described in 3.1.2.7.4.2.8 shall be initiated automatically by the transponder.

3.1.2.7.5 NON-SELECTIVE UPLINK ELM

Note.— In cases where the multisite protocols are not required (for example, no overlapping coverage or sensor coordination via ground-to-ground communication), the non-selective uplink ELM protocol may be used.

Non-selective uplink ELM delivery shall take place as for multisite uplink ELMs described in 3.1.2.7.4.2. The interrogator shall close out an uplink ELM by transmitting PC equals 5 (uplink ELM closeout) in a surveillance or Comm-A interrogation. On receipt of this command, the transponder shall perform closeout, unless the C-timer is running. If the C-timer is running, indicating that a multisite reservation is in effect, the closeout shall be accomplished as per 3.1.2.7.4.2.8. An uncompleted message, present when the closeout is accepted, shall be cancelled.

3.1.2.7.6 ENHANCED UPLINK ELM PROTOCOL

Note.— The enhanced uplink ELM protocol provides a higher data link capacity by permitting parallel delivery of uplink ELM messages by up to sixteen interrogators, one for each II code. Operation without the need for multisite uplink ELM reservations is possible in regions of overlapping coverage for interrogators equipped for the enhanced uplink ELM protocol. The protocol is fully conformant to the standard multisite protocol and thus is compatible with interrogators that are not equipped for the enhanced protocol.

3.1.2.7.6.1 General

3.1.2.7.6.1.1 The interrogator shall determine from the data link capability report whether the transponder supports the enhanced protocols. If the enhanced protocols are not supported by both the interrogator and the transponder, the multisite reservation protocols specified in 3.1.2.7.4.1 shall be used.

Note.— If the enhanced protocols are supported, uplink ELMs delivered using the multisite protocol may be delivered without a prior reservation.

3.1.2.7.6.1.2 **Recommendation.**— If the transponder and the interrogator are equipped for the enhanced protocol, the interrogator should use the enhanced uplink protocol.

3.1.2.7.6.1.3 The transponder shall be capable of storing a sixteen segment message for each of the sixteen II codes.

3.1.2.7.6.2 *Reservation processing.* The transponder shall support reservation processing for each II code as specified in 3.1.2.7.4.1

Note 1.— Reservation processing is required for interrogators that do not support the enhanced protocol.

Note 2.— Since the transponder can process simultaneous uplink ELMs for all sixteen II codes, a reservation will always be granted.

3.1.2.7.6.3 *Enhanced uplink ELM delivery and closeout.* The transponder shall process received segments separately by II code. For each value of II code, uplink ELM delivery and closeout shall be performed as specified in 3.1.2.7.4.2 except that the MD field used to transmit the technical acknowledgment shall also contain the 4-bit (33-36) IIS subfield.

Note.— The interrogator may use the II code contained in the technical acknowledgement in order to verify that it has received the correct technical acknowledgement.

3.1.2.7.7 MULTISITE DOWNLINK ELM PROTOCOL

3.1.2.7.7.1 *Initialization.* The transponder shall announce the presence of a downlink ELM of n segments by making the binary code corresponding to the decimal value $15 + n$ available for insertion in the DR field of a surveillance or Comm-B reply, DF equals 4, 5, 20, 21. This announcement shall remain active until the ELM is closed out (3.1.2.7.7.3, 3.1.2.7.8.1).

3.1.2.7.7.1.1 *Multisite downlink ELM reservation.* An interrogator shall request a reservation for extraction of a downlink ELM by transmitting a surveillance or Comm-A interrogation containing:

DI = 1
 IIS = assigned interrogator identifier
 MES = 3 or 6 (downlink ELM reservation request)

Note.— A multisite downlink ELM reservation request is normally accompanied by a downlink ELM reservation status request (RSS = 3). This causes the interrogator identifier of the reserved interrogator to be inserted in the UM field of the reply.

3.1.2.7.7.1.1.1 Protocol procedure in response to this interrogation shall depend upon the state of the D-timer which indicates if a downlink ELM reservation is active. This timer shall run for T_R seconds.

Note 1.— The value of T_R is given in 3.1.2.10.3.9.

a) if the D-timer is not running, the transponder shall grant a reservation to the requesting interrogator by:

- 1) storing the IIS of the interrogation as the Comm-D II; and
- 2) starting the D-timer.

A multisite downlink ELM reservation shall not be granted by the transponder unless a downlink ELM is waiting to be transmitted.

- b) if the D-timer is running and the IIS of the interrogation equals the Comm-D II, the transponder shall restart the D-timer; and
- c) if the D-timer is running and the IIS of the interrogation does not equal the Comm-D II, there shall be no change to the Comm-D II or D-timer.

Note 2.— In case c) the reservation request has been denied.

3.1.2.7.7.1.1.2 An interrogator shall determine if it is the reserved site through coding in the UM field and, if so, it is authorized to request delivery of the downlink ELM. Otherwise, ELM activity shall not be started during this scan.

Note.— If the interrogator is not the reserved site, a new reservation request may be made during the next scan.

3.1.2.7.7.1.1.3 If downlink ELM activity is not completed on the current scan, the interrogator shall ensure that it still has a reservation before requesting additional segments on a subsequent scan.

3.1.2.7.7.1.2 *Multisite-directed downlink ELM transmissions.* To direct a downlink ELM message to a specific interrogator, the multisite downlink ELM protocol shall be used. When the D-timer is not running, the interrogator identifier of the desired destination shall be stored as the Comm-D II. Simultaneously, the D-timer shall be started and the DR code (3.1.2.7.7.1) shall be set. For a multisite-directed downlink ELM, the D-timer shall not automatically time out but shall continue to run until:

- a) the message is read and closed out by the reserved site; or
- b) the message is cancelled (3.1.2.10.5.4) by the data link avionics.

Note.— The protocols of 3.1.2.7.7.1 will then result in the delivery of the message to the reserved site. The data link avionics may cancel the message if delivery to the reserved site cannot be accomplished.

3.1.2.7.7.2 *Delivery of downlink ELMs.* The interrogator shall extract a downlink ELM by transmitting a Comm-C interrogation with RC equals 3. This interrogation shall carry the SRS subfield which specifies the segments to be transmitted. On receipt of this request, the transponder shall transfer the requested segments by means of Comm-D replies with KE equals 0 and ND corresponding to the number of the segment in MD. The first segment shall be transmitted 128 microseconds plus or minus 0.25 microsecond following the sync phase reversal of the interrogation requesting delivery and subsequent segments shall be transmitted at a rate of one every 136 microseconds plus or minus 1 microsecond. If a request is received to transmit downlink ELM segments and no message is waiting, each reply segment shall contain all ZEROs in the MD field.

Note 1.— The requested segments may be transmitted in any order.

Note 2.— Segments lost in downlink transmissions will be requested again by the interrogator on a subsequent interrogation carrying the SRS subfield. This process is repeated until all segments have been transferred.

3.1.2.7.7.2.1 *SRS, segment request subfield in MC.* This 16-bit (9-24) uplink subfield in MC shall request the transponder to transfer downlink ELM segments. Starting with bit 9, which denotes segment number 0, each of the following bits shall be set to ONE if the transmission of the corresponding segment is requested. SRS shall appear in MC if RC equals 3 in the same interrogation.

3.1.2.7.7.2.2 *D-timer restart.* The D-timer shall be restarted each time that a request for Comm-D segments is received if the Comm-D II is non-zero.

Note.— The requirement for the Comm-D II to be non-zero prevents the D-timer from being restarted during a non-selective downlink ELM transaction.

3.1.2.7.7.3 *Multisite downlink ELM closeout.* The interrogator shall close out a multisite downlink ELM by transmitting either a surveillance or a Comm-A interrogation containing:

either DI = 1
 IIS = assigned interrogator identifier
 MES = 4, 5 or 7 (downlink ELM closeout)

or DI = 0, 1 or 7
 IIS = assigned interrogator identifier
 PC = 6 (downlink ELM closeout).

The transponder shall compare the IIS of the interrogation to the Comm-D II and if the interrogator identifiers do not match, the state of the downlink process shall not be changed.

If the interrogator identifiers match, and if a request for transmission has been complied with at least once, the transponder shall set the Comm-D II to 0, reset the D-timer, clear the DR code for this message and clear the message itself.

If another downlink ELM is waiting to be transmitted, the transponder shall set the DR code (if no Comm-B message is waiting to be delivered) so that the reply contains the announcement of the next message.

3.1.2.7.7.4 *Automatic expiration of downlink ELM reservation.* If the D-timer period expires before a multisite closeout has been accomplished, the Comm-D II shall be set to 0, and the D-timer reset. The message and DR code shall not be cleared.

Note.— *This makes it possible for another site to read and clear this message.*

3.1.2.7.8 *NON-SELECTIVE DOWNLINK ELM*

Note.— *In cases where the multisite protocols are not required (i.e. no overlapping coverage or sensor coordination via ground-to-ground communication), the non-selective downlink ELM protocol may be used.*

Non-selective downlink ELM delivery shall take place as described in 3.1.2.7.7.2.

3.1.2.7.8.1 *Non-selective downlink ELM closeout.* The interrogator shall close out a non-selective downlink ELM by transmitting PC equals 6 (downlink ELM closeout) in a surveillance or Comm-A interrogation. On receipt of this command, and if a request for transmission has been complied with at least once, the transponder shall perform closeout unless the D-timer is running. If the D-timer is running, indicating that a multisite reservation is in effect, the closeout shall be accomplished as per 3.1.2.7.7.3.

3.1.2.7.9 *ENHANCED DOWNLINK ELM PROTOCOL*

Note.— *The enhanced downlink ELM protocol provides a higher data link capacity by permitting parallel delivery of downlink ELM messages by up to sixteen interrogators, one for each II code. Operation without the need for multisite downlink ELM reservations is possible in regions of overlapping coverage for interrogators equipped for the enhanced downlink ELM protocol. The protocol is fully conformant to the standard multisite protocol and thus is compatible with interrogators that are not equipped for the enhanced protocol.*

3.1.2.7.9.1 *General*

3.1.2.7.9.1.1 The interrogator shall determine from the data link capability report whether the transponder supports the enhanced protocols. If the enhanced protocols are not supported by both the interrogator and the transponder, the multisite reservation protocols specified in 3.1.2.6.11 shall be used for multisite and multisite-directed downlink ELMs.

Note.— *If the enhanced protocols are supported, downlink ELMs delivered using the multisite-directed protocol can be delivered without a prior reservation.*

3.1.2.7.9.1.2 **Recommendation.**— *If the transponder and the interrogator are equipped for the enhanced protocol, the interrogator should use the enhanced downlink protocol.*

3.1.2.7.9.2 *Enhanced multisite downlink ELM protocol*

3.1.2.7.9.2.1 The transponder shall be capable of storing a sixteen segment message for each of the sixteen II codes.

3.1.2.7.9.2.2 *Initialization.* A multisite message input into the transponder shall be stored in the registers assigned to II = 0.

3.1.2.7.9.2.3 *Announcement and extraction.* A waiting multisite downlink ELM message shall be announced in the DR field of the replies to all interrogators for which a multisite directed downlink ELM message is not waiting. The UM field of the announcement reply shall indicate that the message is not reserved for any II code, i.e. the IIS subfield shall be set to 0. When a command to reserve this message is received from a given interrogator, the message shall be reserved for the II code contained in the interrogation from that interrogator. After readout and until closeout, the message shall continue to be assigned to that II code. Once a message is assigned to a specific II code, announcement of this message shall no longer be made in the replies to interrogators with other II codes. If the message is not closed out by the associated interrogator for the period of the D-timer, the message shall revert back to multisite status and the process shall repeat. Only one multisite downlink ELM message shall be in process at a time.

3.1.2.7.9.2.4 *Closeout.* A closeout for a multisite message shall only be accepted from the interrogator that was assigned most recently to transfer the message.

3.1.2.7.9.2.5 *Announcement of the next message waiting.* The DR field shall indicate a message waiting in the reply to an interrogation containing a downlink ELM closeout if an unassigned multisite downlink ELM is waiting, or if a multisite directed message is waiting for that II code (3.1.2.7.9.2).

3.1.2.7.9.3 *Enhanced multisite directed downlink ELM protocol*

3.1.2.7.9.3.1 *Initialization.* When a multisite directed message is input into the transponder, it shall be placed in the downlink ELM registers assigned to the II code specified for the message. If the registers for this II code are already in use (i.e. a multisite directed downlink ELM message is already in process for this II code), the new message shall be queued until the current transaction with that II code is closed out.

3.1.2.7.9.3.2 *Announcement.* Announcement of a downlink ELM message waiting transfer shall be made using the DR field as specified in 3.1.2.7.7.1 with the destination interrogator II code contained in the IIS subfield as specified in 3.1.2.6.5.3.2. The DR field and IIS subfield contents shall be set specifically for the interrogator that is to receive the reply. A waiting multisite directed message shall only be announced in the replies to the intended interrogator. It shall not be announced in replies to other interrogators.

3.1.2.7.9.3.3 *Delivery.* An interrogator shall determine if it is the reserved site through coding in the UM field. The delivery shall only be requested if it is the reserved site and shall be as specified in 3.1.2.7.7.2. The transponder shall transmit the message contained in the buffer associated with the II code specified in the IIS subfield of the segment request interrogation.

3.1.2.7.9.3.4 *Closeout.* Closeout shall be accomplished as specified in 3.1.2.7.7.3 except that a message closeout shall only be accepted from the interrogator with a II code equal to the one that transferred the message.

3.1.2.7.9.3.5 *Announcement of the next message waiting.* The DR field shall indicate a message waiting in the reply to an interrogation containing a downlink ELM closeout if another multisite directed message is waiting for that II code, or if a downlink message is waiting that has not been assigned a II code (3.1.2.7.9.2).

3.1.2.7.9.4 *Enhanced non-selective downlink ELM protocol.* The availability of a non-selective downlink ELM message shall be announced to all interrogators. Otherwise, the protocol shall be as specified in 3.1.2.7.7.

3.1.2.8 AIR-AIR SERVICE AND SQUITTER TRANSACTIONS

Note.— Airborne collision avoidance system (ACAS) equipment uses the formats UF or DF equals 0 or 16 for air-air surveillance.

3.1.2.8.1 SHORT AIR-AIR SURVEILLANCE, UPLINK FORMAT 0

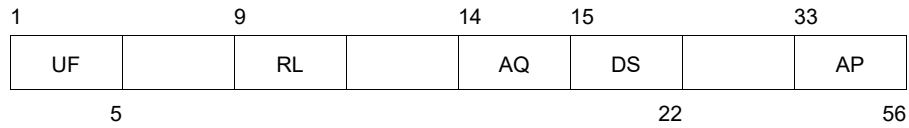

The format of this interrogation shall consist of these fields:

<i>Field</i>	<i>Reference</i>
UF uplink format spare — 3 bits	3.1.2.3.2.1.1
RL reply length spare — 4 bits	3.1.2.8.1.2
AQ acquisition	3.1.2.8.1.1
DS data selector spare — 10 bits	3.1.2.8.1.3
AP address/parity	3.1.2.3.2.1.3

3.1.2.8.1.1 *AQ: Acquisition.* This 1-bit (14) uplink field shall contain a code which controls the content of the RI field.

3.1.2.8.1.2 *RL: Reply length.* This 1-bit (9) uplink field shall command the format to be used for the reply.

Coding

- 0 signifies a reply with DF = 0
- 1 signifies a reply with DF = 16

Note.— A transponder that does not support DF = 16 (i.e. transponder which does not support the ACAS cross-link capability and is not associated with airborne collision avoidance equipment) would not reply to a UF=0 interrogation with RL=1.

3.1.2.8.1.3 *DS: Data selector.* This 8-bit (15-22) uplink field shall contain the BDS code (3.1.2.6.11.2.1) of the GICB register whose contents shall be returned to the corresponding reply with DF = 16.

3.1.2.8.2 SHORT AIR-AIR SURVEILLANCE, DOWNLINK FORMAT 0

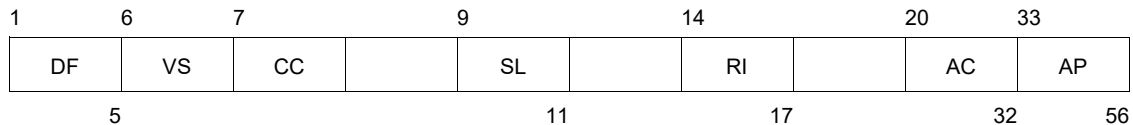

This reply shall be sent in response to an interrogation with UF equals 0 and RL equals 0. The format of this reply shall consist of these fields:

<i>Field</i>	<i>Reference</i>
DF downlink format	3.1.2.3.2.1.2
VS vertical status	3.1.2.8.2.1
CC cross-link capability spare — 1 bit	3.1.2.8.2.3

SL sensitivity level, ACAS spare — 2 bits	4.3.8.4.2.5
RI reply information spare — 2 bits	3.1.2.8.2.2
AC altitude code	3.1.2.6.5.4
AP address/parity	3.1.2.3.2.1.3

3.1.2.8.2.1 *VS: Vertical status:* This 1-bit (6) downlink field shall indicate the status of the aircraft (3.1.2.6.10.1.2).

Coding

- 0 signifies that the aircraft is airborne
- 1 signifies that the aircraft is on the ground

3.1.2.8.2.2 *RI: Reply information, air-air.* This 4-bit (14-17) downlink field shall report the aircraft's maximum cruising true airspeed capability and type of reply to interrogating aircraft. The coding shall be as follows:

- 0 signifies a reply to an air-air interrogation UF = 0 with AQ = 0, no operating ACAS
- 1-7 reserved for ACAS
- 8-15 signifies a reply to an air-air interrogation UF = 0 with AQ = 1 and that the maximum airspeed is as follows:
 - 8 no maximum airspeed data available
 - 9 maximum airspeed is .LE. 140 km/h (75 kt)
 - 10 maximum airspeed is .GT. 140 and .LE. 280 km/h (75 and 150 kt)
 - 11 maximum airspeed is .GT. 280 and .LE. 560 km/h (150 and 300 kt)
 - 12 maximum airspeed is .GT. 560 and .LE. 1 110 km/h (300 and 600 kt)
 - 13 maximum airspeed is .GT. 1 110 and .LE. 2 220 km/h (600 and 1 200 kt)
 - 14 maximum airspeed is more than 2 220 km/h (1 200 kt)
 - 15 not assigned.

Note. — “.LE.” means “less than or equal to” and “.GT.” means “greater than”.

3.1.2.8.2.3 *CC: Cross-link capability.* This 1-bit (7) downlink field shall indicate the ability of the transponder to support the cross-link capability, i.e. decode the contents of the DS field in an interrogation with UF equals 0 and respond with the contents of the specified GICB register in the corresponding reply with DF equals 16.

Coding

- 0 signifies that the transponder cannot support the cross-link capability
- 1 signifies that the transponder supports the cross-link capability.

3.1.2.8.3 *LONG AIR-AIR SURVEILLANCE, DOWNLINK FORMAT 16*

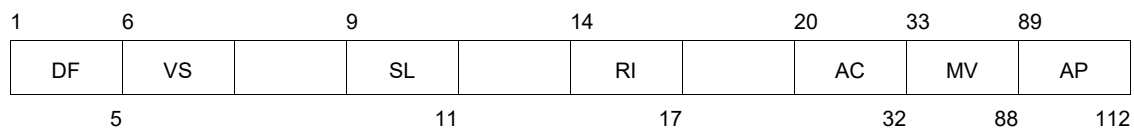

This reply shall be sent in response to an interrogation with UF equals 0 and RL equals 1. The format of this reply shall consist of these fields:

<i>Field</i>	<i>Reference</i>
DF downlink format	3.1.2.3.2.1.2
VS vertical status	3.1.2.8.2.1
spare — 2 bits	
SL sensitivity level, ACAS	4.3.8.4.2.5
spare — 2 bits	
RI reply information	3.1.2.8.2.2
spare — 2 bits	
AC altitude code	3.1.2.6.5.4
MV message, ACAS	3.1.2.8.3.1
AP address/parity	3.1.2.3.2.1.3

3.1.2.8.3.1 *MV: Message, ACAS.* This 56-bit (33-88) downlink field shall contain GICB information as requested in the DS field of the UF 0 interrogation that elicited the reply.

Note.— *The MV field is also used by ACAS for air-air coordination (4.3.8.4.2.4).*

3.1.2.8.4 *AIR-AIR TRANSACTION PROTOCOL*

Note.— *Interrogation-reply coordination for the air-air formats follows the protocol outlined in Table 3-5 (3.1.2.4.1.3.2.2).*

The most significant bit (bit 14) of the RI field of an air-air reply shall replicate the value of the AQ field (bit 14) received in an interrogation with UF equals 0.

If AQ equals 0 in the interrogation, the RI field of the reply shall contain the value 0.

If AQ equals 1 in the interrogation, the RI field of the reply shall contain the maximum cruising true airspeed capability of the aircraft as defined in 3.1.2.8.2.2.

In response to a UF = 0 with RL = 1 and DS \neq 0, the transponder shall reply with a DF = 16 reply in which the MV field shall contain the contents of the GICB register designated by the DS value. If the requested register is not serviced by the aircraft installation, the transponder shall reply and the MV field of the reply shall contain all ZEROS.

3.1.2.8.5 *ACQUISITION SQUITTER*

Note.— *SSR Mode S transponders transmit acquisition squitters (unsolicited downlink transmissions) to permit passive acquisition by interrogators with broad antenna beams, where active acquisition may be hindered by all-call synchronous garble. Examples of such interrogators are an airborne collision avoidance system and an airport surface surveillance system.*

3.1.2.8.5.1 *Acquisition squitter format.* The format used for acquisition squitter transmissions shall be the all-call reply, (DF = 11) with II = 0.

3.1.2.8.5.2 *Acquisition squitter rate.* Acquisition squitter transmissions shall be emitted at random intervals that are uniformly distributed over the range from 0.8 to 1.2 seconds using a time quantization of no greater than 15 milliseconds relative to the previous acquisition squitter, with the following exceptions:

- a) the scheduled acquisition squitter shall be delayed if the transponder is in a transaction cycle (3.1.2.4.1);

- b) the acquisition squitter shall be delayed if an extended squitter is in process;
- c) the scheduled acquisition squitter shall be delayed if a mutual suppression interface is active (see Note 1 below); or
- d) acquisition squitters shall only be transmitted on the surface if the transponder is not reporting the surface position type of Mode S extended squitter.

An acquisition squitter shall not be interrupted by link transactions or mutual suppression activity after the squitter transmission has begun.

Note 1.— A mutual suppression system may be used to connect onboard equipment operating in the same frequency band in order to prevent mutual interference. Acquisition squitter action resumes as soon as practical after a mutual suppression interval.

Note 2.— The surface report type may be selected automatically by the aircraft or by commands from a squitter ground station (3.1.2.8.6.7).

3.1.2.8.5.3 *Acquisition squitter antenna selection.* Transponders operating with antenna diversity (3.1.2.10.4) shall transmit acquisition squitters as follows:

- a) when airborne (3.1.2.8.6.7), the transponder shall transmit acquisition squitters alternately from the two antennas; and
- b) when on the surface (3.1.2.8.6.7), the transponder shall transmit acquisition squitters under control of SAS (3.1.2.6.1.4.1 f). In the absence of any SAS commands, use of the top antenna only shall be the default.

Note.— Acquisition squitters are not emitted on the surface if the transponder is reporting the surface type of extended squitter (3.1.2.8.6.4.3).

3.1.2.8.6 EXTENDED SQUITTER, DOWNLINK FORMAT 17

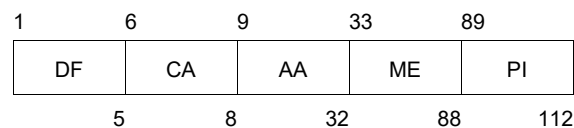

Note.— SSR Mode S transponders transmit extended squitters to support the broadcast of aircraft-derived position for surveillance purposes. The broadcast of this type of information is a form of automatic dependent surveillance (ADS) known as ADS-broadcast (ADS-B).

3.1.2.8.6.1 *Extended squitter format.* The format used for the extended squitter shall be a 112-bit downlink format (DF = 17) containing the following fields:

<i>Field</i>	<i>Reference</i>
DF downlink format	3.1.2.3.2.1.2
CA capability	3.1.2.5.2.2.1
AA address, announced	3.1.2.5.2.2.2
ME message, extended squitter	3.1.2.8.6.2
PI parity/interrogator identifier	3.1.2.3.2.1.4

The PI field shall be encoded with II equal to 0.

3.1.2.8.6.2 *ME: Message, extended squitter.* This 56-bit (33-88) downlink field in DF = 17 shall be used to transmit broadcast messages. Extended squitter shall be supported by registers 05, 06, 07, 08, 09, 0A {HEX} and 61-6F {HEX} and shall conform to either version 0, version 1 or version 2 message formats as described below:

- a) Version 0 ES message formats and related requirements report surveillance quality by navigation uncertainty category (NUC), which can be an indication of either the accuracy or integrity of the navigation data used by ADS-B. However, there is no indication as to which of these, integrity or accuracy, the NUC value is providing an indication of.
- b) Version 1 ES message formats and related requirements report surveillance accuracy and integrity separately as navigation accuracy category (NAC), navigation integrity category (NIC) and surveillance integrity level (SIL). Version 1 ES formats also include provisions for enhanced reporting of status information; and
- c) Version 2 ES message formats and related requirements contain the provisions of version 1 but further enhance integrity and parameter reporting. Version 2 ES formats separately report position source integrity from the integrity of the ADS-B transmitting equipment. Version 2 ES formats also separate vertical accuracy reporting from horizontal position accuracy, remove vertical integrity from position integrity, and provide for the reporting of the SSR Mode A code, GNSS antenna offset and additional horizontal position integrity values. Version 2 ES formats also modify the target state report to include selected altitude, selected heading, and barometric pressure setting.

Note 1.— The formats and update rates of each register are specified in the Technical Provisions for Mode S Services and Extended Squitter (Doc 9871). The formats and update rates for individual squitters are defined by the version number of the extended squitter.

Note 2.— The formats for the three different versions are interoperable. An extended squitter receiver can recognize and decode signals of its own version, as well as lower versions' message formats. The receiver, however, can decode higher version signals according to its own capability.

Note 3.— Guidance material on transponder register formats and data sources is included in the Technical Provisions for Mode S Services and Extended Squitter (Doc 9871).

3.1.2.8.6.3 *Extended squitter types*

3.1.2.8.6.3.1 *Airborne position squitter.* The airborne position extended squitter type shall use format DF = 17 with the contents of GICB register 05 {HEX} inserted in the ME field.

Note.— A GICB request (3.1.2.6.11.2) containing RR equals 16 and DI equals 3 or 7 and RRS equals 5 will cause the resulting reply to contain the airborne position message in its MB field.

3.1.2.8.6.3.1.1 *SSS, surveillance status subfield in ME.* The transponder shall report the surveillance status of the transponder in this 2-bit (38, 39) subfield of ME when ME contains an airborne position message.

Coding

- | | |
|---|--|
| 0 | signifies no status information |
| 1 | signifies transponder reporting permanent alert condition (3.1.2.6.10.1.1.1) |
| 2 | signifies transponder reporting a temporary alert condition (3.1.2.6.10.1.1.2) |
| 3 | signifies transponder reporting SPI condition (3.1.2.6.10.1.3) |

Codes 1 and 2 shall take precedence over code 3.

3.1.2.8.6.3.1.2 *ACS, altitude code subfield in ME.* Under control of ATS (3.1.2.8.6.3.1.3), the transponder shall report either navigation-derived altitude, or the barometric altitude code in this 12-bit (41-52) subfield of ME when ME contains an airborne position message. When barometric altitude is reported, the contents of the ACS shall be as specified for the 13-bit AC field (3.1.2.6.5.4) except that the M-bit (bit 26) shall be omitted.

3.1.2.8.6.3.1.3 *Control of ACS reporting.* Transponder reporting of altitude data in ACS shall depend on the altitude type subfield (ATS) as specified in 3.1.2.8.6.8.2. Transponder insertion of barometric altitude data in the ACS subfield shall take place when the ATS subfield has the value of ZERO. Transponder insertion of barometric altitude data in ACS shall be inhibited when ATS has the value 1.

3.1.2.8.6.3.2 *Surface position squitter.* The surface position extended squitter type shall use format DF = 17 with the contents of GICB register 06 {HEX} inserted in the ME field.

Note.— A GICB request (3.1.2.6.11.2) containing RR equals 16 and DI equals 3 or 7 and RRS equals 6 will cause the resulting reply to contain the surface position message in its MB field..

3.1.2.8.6.3.3 *Aircraft identification squitter.* The aircraft identification extended squitter type shall use format DF = 17 with the contents of GICB register 08 {HEX} inserted in the ME field.

Note.— A GICB request (3.1.2.6.11.2) containing RR equals 16 and DI equals 3 or 7 and RRS equals 8 will cause the resulting reply to contain the aircraft identification message in its MB field.

3.1.2.8.6.3.4 *Airborne velocity squitter.* The airborne velocity extended squitter type shall use format DF = 17 with the contents of GICB register 09 {HEX} inserted in the ME field.

Note.— A GICB request (3.1.2.6.11.2) containing RR equals 16 and DI equals 3 or 7 and RRS equals 9 will cause the resulting reply to contain the airborne velocity message in its MB field.

3.1.2.8.6.3.5 *Periodic status and event-driven squitters*

3.1.2.8.6.3.5.1 *Periodic status squitter.* The periodic status extended squitter types shall use format DF = 17 to convey aircraft status and other surveillance data. The aircraft operational status extended squitter type shall use the contents of GICB register 65 {HEX} inserted in the ME field. The target state and status extended squitter type shall use the contents of GICB register 62 {HEX} inserted in the ME field.

Note 1.— A GICB request (3.1.2.6.11.2) containing RR equals 22 and DI equals 3 or 7 and RRS equals 5 will cause the resulting reply to contain the aircraft operational status message in its MB field.

Note 2.— A GICB request (3.1.2.6.11.2) containing RR equals 22 and DI equals 3 or 7 and RRS equals 2 will cause the resulting reply to contain the target state and status information in its MB field.

3.1.2.8.6.3.5.2 *Event-driven squitter.* The event-driven extended squitter type shall use format DF = 17 with the contents of GICB register 0A {HEX} inserted in the ME field.

Note.— A GICB request (3.1.2.6.11.2) containing RR equals 16 and DI equals 3 or 7 and RRS equals 10 will cause the resulting reply to contain the event-driven message in its MB field.

3.1.2.8.6.4 *Extended squitter rate*

3.1.2.8.6.4.1 *Initialization.* At power up initialization, the transponder shall commence operation in a mode in which it broadcasts only acquisition squitters (3.1.2.8.5). The transponder shall initiate the broadcast of extended squitters for airborne position, surface position, airborne velocity and aircraft identification when data are inserted into transponder registers 05, 06,

09 and 08 {HEX}, respectively. This determination shall be made individually for each squitter type. When extended squitters are broadcast, transmission rates shall be as indicated in the following paragraphs. Acquisition squitters shall be reported in addition to extended squitters unless the acquisition squitter is inhibited (2.1.5.4). Acquisition squitters shall always be reported if both position and velocity extended squitters are not reported.

Note 1.— This suppresses the transmission of extended squitters from aircraft that are unable to report position, velocity or identity. If input to the register for the position squitter type stops for 60 seconds, broadcast will be discontinued until data insertion is resumed. Broadcast of airborne position squitters is not discontinued if barometric altitude data is available. Terminating broadcast of other squitter types is described in Technical Provisions for Mode S Services and Extended Squitter (Doc 9871).

Note 2.— After timeout (3.1.2.8.6.6), the position squitter type may contain an ME field of all zeroes.

3.1.2.8.6.4.2 *Airborne position squitter rate.* Airborne position squitter transmissions shall be emitted when the aircraft is airborne (3.1.2.8.6.7) at random intervals that are uniformly distributed over the range from 0.4 to 0.6 seconds using a time quantization of no greater than 15 milliseconds relative to the previous airborne position squitter, with the exceptions as specified in 3.1.2.8.6.4.7.

3.1.2.8.6.4.3 *Surface position squitter rate.* Surface position squitter transmissions shall be emitted when the aircraft is on the surface (3.1.2.8.6.7) using one of two rates depending upon whether the high or low squitter rate has been selected (3.1.2.8.6.9). When the high squitter rate has been selected, surface position squitters shall be emitted at random intervals that are uniformly distributed over the range from 0.4 to 0.6 seconds using a time quantization of no greater than 15 milliseconds relative to the previous surface position squitter (termed the high rate). When the low squitter rate has been selected, surface position squitters shall be emitted at random intervals that are uniformly distributed over the range of 4.8 to 5.2 seconds using a time quantization of no greater than 15 milliseconds relative to the previous surface position squitter (termed the low rate). Exceptions to these transmission rates are specified in 3.1.2.8.6.4.7.

3.1.2.8.6.4.4 *Aircraft identification squitter rate.* Aircraft identification squitter transmissions shall be emitted at random intervals that are uniformly distributed over the range of 4.8 to 5.2 seconds using a time quantization of no greater than 15 milliseconds relative to the previous identification squitter when the aircraft is reporting the airborne position squitter type, or when the aircraft is reporting the surface position squitter type and the high surface squitter rate has been selected. When the surface position squitter type is being reported at the low surface rate, the aircraft identification squitter shall be emitted at random intervals that are uniformly distributed over the range of 9.8 to 10.2 seconds using a time quantization of no greater than 15 milliseconds relative to the previous identification squitter. Exceptions to these transmission rates are specified in 3.1.2.8.6.4.7.

3.1.2.8.6.4.5 *Airborne velocity squitter rate.* Airborne velocity squitter transmissions shall be emitted when the aircraft is airborne (3.1.2.8.6.7) at random intervals that are uniformly distributed over the range from 0.4 to 0.6 seconds using a time quantization of no greater than 15 milliseconds relative to the previous airborne velocity squitter, with the exceptions as specified in 3.1.2.8.6.4.7.

3.1.2.8.6.4.6 *Periodic status and event-driven squitter rates*

3.1.2.8.6.4.6.1 *Periodic status squitter rates.* The periodic status squitter types supported by a Mode S extended squitter transmitting system class, as specified in 5.1.1.2, shall be periodically emitted at defined intervals depending on the on-the-ground status and whether their content has changed.

Note.— The aircraft operational status extended squitter type and the target state and status extended squitter type rates are specified in the Technical Provisions for Mode S Services and Extended Squitter (Doc 9871).

3.1.2.8.6.4.6.2 *Event-driven squitter rate.* The event-driven squitter shall be transmitted once, each time that GICB register 0A {HEX} is loaded, while observing the delay conditions specified in 3.1.2.8.6.4.7. The maximum transmission rate for the event-driven squitter shall be limited by the transponder to twice per second. If a message is inserted in the event-driven register and cannot be transmitted due to rate limiting, it shall be held and transmitted when the rate limiting condition has cleared. If a new message is received before transmission is permitted, it shall overwrite the earlier message.

3.1.2.8.6.4.7 *Delayed transmission.* Extended squitter transmission shall be delayed in the following circumstances:

- a) if the transponder is in a transaction cycle (3.1.2.4.1);
- b) if an acquisition or another type of extended squitter is in process; or
- c) if a mutual suppression interface is active.

The delayed squitter shall be transmitted as soon as the transponder becomes available.

3.1.2.8.6.5 *Extended squitter antenna selection.* Transponders operating with antenna diversity (3.1.2.10.4) shall transmit extended squitters as follows:

- a) when airborne (3.1.2.8.6.7), the transponder shall transmit each type of extended squitter alternately from the two antennas; and
- b) when on the surface (3.1.2.8.6.7), the transponder shall transmit extended squitters under control of SAS (3.1.2.6.1.4.1 f)).

In the absence of any SAS commands, use of the top antenna only shall be the default condition.

3.1.2.8.6.6 *Register time-out and termination.* The transponder shall clear and terminate broadcast of information in extended squitter registers as required to prevent the reporting of outdated information.

Note.— *Timeout and termination of extended squitter broadcast is specified in the Technical Provisions for Mode S Services and Extended Squitter (Doc 9871).*

3.1.2.8.6.7 *Airborne/surface state determination.* Aircraft with an automatic means of determining on-the-ground conditions shall use this input to select whether to report the airborne or surface message types. Aircraft without such means shall report the airborne type messages, except as specified in Table 3-7. Use of this table shall only be applicable to aircraft that are equipped to provide data for radio altitude AND, as a minimum, airspeed OR ground speed. Otherwise, aircraft in the specified categories that are only equipped to provide data for airspeed and ground speed shall broadcast the surface format if:

airspeed < 50 knots AND ground speed < 50 knots

Aircraft with or without such automatic on-the-ground determination shall use position message types as commanded by control codes in TCS (3.1.2.6.1.4.1 f)). After time-out of the TCS commands, control of airborne/surface determination shall revert to the means described above.

Note 1.— *Use of this technique may result in the surface position format being transmitted when the air-ground status in the CA fields indicates “airborne or on the ground”.*

Note 2.— *Extended squitter ground stations determine aircraft airborne or on-the-ground status by monitoring aircraft position, altitude and ground speed. Aircraft determined to be on the ground that are not reporting the surface position message types will be commanded to report the surface formats via TCS (3.1.2.6.1.4.1 f)). The normal return to the airborne position message types is via a ground command to report airborne message types. To guard against loss of communications after take-off, commands to report the surface position message types automatically time-out.*

3.1.2.8.6.8 *Squitter status reporting.* A GICB request (3.1.2.6.11.2) containing RR equals 16 and DI equals 3 or 7 and RRS equals 7 shall cause the resulting reply to contain the squitter status report in its MB field.

3.1.2.8.6.8.1 *TRS, transmission rate subfield in MB.* The transponder shall report the capability of the aircraft to automatically determine its surface squitter rate and its current squitter rate in this 2-bit (33, 34) subfield of MB.

Coding

- | | |
|---|--|
| 0 | signifies no capability to automatically determine surface squitter rate |
| 1 | signifies that the high surface squitter rate has been selected |
| 2 | signifies that the low surface squitter rate has been selected |
| 3 | unassigned |

Note 1.— High and low squitter rate is determined on board the aircraft.

Note 2.— The low rate is used when the aircraft is stationary and the high rate is used when the aircraft is moving. For details of how “moving” is determined, see the data format of register 07₁₆ in the Technical Provisions for Mode S Services and Extended Squitter (Doc 9871).

3.1.2.8.6.8.2 *ATS, altitude type subfield in MB.* The transponder shall report the type of altitude being provided in the airborne position extended squitter in this 1-bit (35) subfield of MB when the reply contains the contents of transponder register 07 {HEX}.

Coding

- | | |
|---|---|
| 0 | signifies that barometric altitude shall be reported in the ACS (3.1.2.8.6.3.1.2) of transponder register 05 {HEX}. |
| 1 | signifies that navigation-derived altitude shall be reported in the ACS (3.1.2.8.6.3.1.2) of transponder register 05 {HEX}. |

Note.— Details of the contents of transponder registers 05 {HEX} and 07 {HEX} are shown in the Technical Provisions for Mode S Services and Extended Squitter (Doc 9871).

3.1.2.8.6.9 *Surface squitter rate control.* Surface squitter rate shall be determined as follows:

- a) once per second the contents of the TRS shall be read. If the value of TRS is 0 or 1, the transponder shall transmit surface squitters at the high rate. If the value of TRS is 2, the transponder shall transmit surface squitters at the low rate;
- b) the squitter rate determined via TRS shall be subject to being overridden by commands received via RCS (3.1.2.6.1.4.1 f). RCS code 1 shall cause the transponder to squitter at the high rate for 60 seconds. RCS code 2 shall cause the transponder to squitter at the low rate for 60 seconds. These commands shall be able to be refreshed for a new 60 second period before time-out of the prior period; and
- c) after time-out and in the absence of RCS codes 1 and 2, control shall return to TRS.

3.1.2.8.6.10 *Latitude/longitude coding using compact position reporting (CPR).* Mode S extended squitter shall use compact position reporting (CPR) to encode latitude and longitude efficiently into messages.

Note.— The method used to encode/decode CPR is specified in the Technical Provisions for Mode S Services and Extended Squitter (Doc 9871).

3.1.2.8.6.11 *Data insertion.* When the transponder determines that it is time to emit an airborne position squitter, it shall insert the current value of the barometric altitude (unless inhibited by the ATS subfield, 3.1.2.8.6.8.2) and surveillance status into the appropriate fields of register 05 {HEX}. The contents of this register shall then be inserted into the ME field of DF = 17 and transmitted.

Note.— Insertion in this manner ensures that (1) the squitter contains the latest altitude and surveillance status, and (2) ground read-out of register 05 {HEX} will yield exactly the same information as the AC field of a Mode S surveillance reply.

3.1.2.8.7 EXTENDED SQUITTER/SUPPLEMENTARY, DOWNLINK FORMAT 18

10010	CF:3			PI:24
-------	------	--	--	-------

Note 1.— This format supports the broadcast of extended squitter ADS-B messages by non-transponder devices, i.e. they are not incorporated into a Mode S transponder. A separate format is used to clearly identify this non-transponder case to prevent ACAS II or extended squitter ground stations from attempting to interrogate these devices.

Note 2.— This format is also used for ground broadcast of ADS-B related services such as traffic information broadcast (TIS-B).

Note 3.— The format of the DF = 18 transmission is defined by the value of the CF field.

3.1.2.8.7.1 *ES supplementary format.* The format used for ES supplementary shall be a 112-bit downlink format (DF = 18) containing the following fields:

<i>Field</i>	<i>Reference</i>
DF downlink format	3.1.2.3.2.1.2
CF control field	3.1.2.8.7.2
PI parity/interrogator identifier	3.1.2.3.2.1.4

The PI field shall be encoded with II equal to zero.

3.1.2.8.7.2 *Control field.* This 3-bit (6-8) downlink field in DF = 18 shall be used to define the format of the 112-bit transmission as follows.

Code 0 = ADS-B ES/NT devices that report the ICAO 24-bit address in the AA field (3.1.2.8.7.3)

Code 1 = Reserved for ADS-B for ES/NT devices that use other addressing techniques in the AA field (3.1.2.8.7.3)

Code 2 = Fine format TIS-B message

Code 3 = Coarse format TIS-B message

Code 4 = Reserved for TIS-B management messages

Code 5 = TIS-B messages that relay ADS-B messages that use other addressing techniques in the AA field

Code 6 = ADS-B rebroadcast using the same type codes and message formats as defined for DF = 17 ADS-B messages

Code 7 = Reserved

Note 1.— Administrations may wish to make address assignments for ES/NT devices in addition to the 24-bit addresses allocated by ICAO (Annex 10, Volume III, Part I, Chapter 9) in order to increase the available number of 24-bit addresses.

Note 2.— These non-ICAO 24-bit addresses are not intended for international use.

3.1.2.8.7.3 ADS-B for extended squitter/non-transponder (ES/NT) devices

10010	CF=0	AA:24	ME:56	PI:24
-------	------	-------	-------	-------

3.1.2.8.7.3.1 *ES/NT format.* The format used for ES/NT shall be a 112-bit downlink format (DF = 18) containing the following fields:

<i>Field</i>	<i>Reference</i>
DF downlink format	3.1.2.3.2.1.2
CF control field = 0	3.1.2.8.7.2
AA address, announced	3.1.2.5.2.2.2
ME message, extended squitter	3.1.2.8.6.2
PI parity/interrogator identifier	3.1.2.3.2.1.4

The PI field shall be encoded with II equal to zero.

3.1.2.8.7.3.2 *ES/NT squitter types*

3.1.2.8.7.3.2.1 *Airborne position squitter.* The airborne position type ES/NT shall use format DF = 18 with the format for register 05 {HEX} as defined in 3.1.2.8.6.2 inserted in the ME field.

3.1.2.8.7.3.2.2 *Surface position squitter.* The surface position type ES/NT shall use format DF = 18 with the format for register 06 {HEX} as defined in 3.1.2.8.6.2 inserted in the ME field.

3.1.2.8.7.3.2.3 *Aircraft identification squitter.* The aircraft identification type ES/NT shall use format DF = 18 with the format for register 08 {HEX} as defined in 3.1.2.8.6.2 inserted in the ME field.

3.1.2.8.7.3.2.4 *Airborne velocity squitter.* The airborne velocity type ES/NT shall use format DF = 18 with the format for register 09 {HEX} as defined in 3.1.2.8.6.2 inserted in the ME field.

3.1.2.8.7.3.2.5 *Periodic status and event-driven squitters*

3.1.2.8.7.3.2.5.1 *Periodic status squitters.* The periodic status extended squitter types shall use format DF = 18 to convey aircraft status and other surveillance data. The aircraft operational status extended squitter type shall use the format of GICB register 65 {HEX} as defined in 3.1.2.8.6.4.6.1 inserted in the ME field. The target state and status extended squitter type shall use the format of GICB register 62 {HEX} as defined in 3.1.2.8.6.4.6.1 inserted in the ME field.

3.1.2.8.7.3.2.5.2 *Event-driven squitter.* The event-driven type ES/NT shall use format DF = 18 with the format for register 0A {HEX} as defined in 3.1.2.8.6.2 inserted in the ME field.

3.1.2.8.7.3.3 *ES/NT squitter rate*

3.1.2.8.7.3.3.1 *Initialization.* At power up initialization, the non-transponder device shall commence operation in a mode in which it does not broadcast any squitters. The non-transponder device shall initiate the broadcast of ES/NT squitters for airborne position, surface position, airborne velocity and aircraft identification when data are available for inclusion in the ME field of these squitter types. This determination shall be made individually for each squitter type. When ES/NT squitters are broadcast, transmission rates shall be as indicated in 3.1.2.8.6.4.2 to 3.1.2.8.6.4.6.

Note 1.— This suppresses the transmission of extended squitters from aircraft that are unable to report position, velocity or identity. If input to the register for the position squitter type stops for 60 seconds, broadcast will cease until data insertion resumes, except for an ES/NT device operating on the surface (as specified in the Technical Provisions for Mode S Services and Extended Squitter (Doc 9871)). Broadcast of airborne position squitters is not discontinued if barometric altitude data is available. Terminating broadcast of other squitter types is described in Doc 9871.

Note 2.— After timeout (3.1.2.8.7.6) this squitter type may contain an ME field of all zeros.

3.1.2.8.7.3.3.2 *Delayed transmission.* ES/NT squitter transmission shall be delayed if the non-transponder device is busy broadcasting one of the other squitter types.

3.1.2.8.7.3.3.2.1 The delayed squitter shall be transmitted as soon as the non-transponder device becomes available.

3.1.2.8.7.3.3.3 *ES/NT antenna selection.* Non-transponder devices operating with antenna diversity (3.1.2.10.4) shall transmit ES/NT squitters as follows:

- a) when airborne (3.1.2.8.6.7), the non-transponder device shall transmit each type of ES/NT squitter alternately from the two antennas; and
- b) when on the surface (3.1.2.8.6.7), the non-transponder device shall transmit ES/NT squitters using the top antenna.

3.1.2.8.7.3.3.4 *Register timeout and termination.* The non-transponder device shall clear message fields and terminate broadcast of extended squitter messages as required to prevent the reporting of outdated information.

Note.— The timeout and termination of an extended squitter broadcast is specified in the Technical Provisions for Mode S Services and Extended Squitter (Doc 9871).

3.1.2.8.7.3.3.5 *Airborne/surface state determination.* Aircraft with an automatic means of determining the on-the-ground state shall use this input to select whether to report the airborne or surface message types except as specified in 3.1.2.6.10.3.1. Aircraft without such means shall report the airborne type message.

3.1.2.8.7.3.3.6 *Surface squitter rate control.* Aircraft motion shall be determined once per second. The surface squitter rate shall be set according to the results of this determination.

Note.— The algorithm to determine aircraft motion is specified in the definition of register 07₁₆ in the Technical Provisions for Mode S Services and Extended Squitter (Doc 9871).

3.1.2.8.7.4 *Use of ES by other surveillance systems.*

3.1.2.8.7.4.1 *Surface system control*

Recommendation.— When a surface surveillance system uses DF=18 as part of a surveillance function, it should not use the formats that have been allocated for the purpose of surveillance of aircraft, vehicles and/or obstacles.

Note 1.— The formats allocated for the purpose of surveillance of aircraft, vehicles and/or obstacles are specified in the Technical Provisions for Mode S Services and Extended Squitter (Doc 9871).

Note 2.— The transmission of any message format used for conveying position, velocity, identification, state information, etc., may result in the initiation and maintenance of false tracks in other 1090ES receivers. The use of these messages for this purpose may be prohibited in the future.

3.1.2.8.7.4.2 *Surface system status*

Recommendation.— The surface system status message type (Type Code=24) should be the only message used to provide the status or synchronization of surface surveillance systems.

Note.— The surface system status message is specified in the Technical Provisions for Mode S Services and Extended Squitter (Doc 9871). This message will be used only by the surface surveillance system that generated it and will be ignored by other surface systems.

3.1.2.8.8 EXTENDED SQUITTER MILITARY APPLICATION, DOWNLINK FORMAT 19

10011	AF:3	
-------	------	--

Note.— This format supports the broadcast of extended squitter ADS-B messages in support of military applications. A separate format is used to distinguish these extended squitters from the standard ADS-B message set broadcast using DF = 17 or 18.

3.1.2.8.8.1 *Military format.* The format used for DF = 19 shall be a 112-bit downlink format containing the following fields:

<i>Field</i>	<i>Reference</i>
DF downlink format	3.1.2.3.2.1.2
AF control field	3.1.2.8.8.2

3.1.2.8.8.2 *Application field.* This 3-bit (6-8) downlink field in DF = 19 shall be used to define the format of the 112-bit transmission.

Code 0 to 7 = Reserved

3.1.2.8.9 EXTENDED SQUITTER MAXIMUM TRANSMISSION RATE

3.1.2.8.9.1 The maximum total number of full power extended squitters (DF = 17, 18 and 19) emitted by any extended squitter installation shall not exceed the following:

- a) 6.2 messages per second averaged over 60 seconds for nominal aircraft operations with no emergency and no ACAS RA activity, while not exceeding 11 messages being transmitted in any 1-second interval; or
- b) 7.4 messages per second averaged over 60 seconds under an emergency and/or ACAS RA condition, while not exceeding 11 messages being transmitted in any 1-second interval.

3.1.2.8.9.2 For installations capable of emitting DF = 19 squitters and in accordance with 3.1.2.8.8, transmission rates for lower power DF = 19 squitters shall be limited to a peak of forty DF = 19 squitters per second, and thirty DF = 19 squitters per second averaged over 10 seconds, provided that the maximum total squitter power-rate product for the sum of full power DF = 17 squitters, full power DF = 18 squitters, full power DF = 19 squitters, and lower power DF = 19 squitters, is maintained at or below a level equivalent to the power sum of 6.2 full power squitters per second averaged over 10 seconds.

3.1.2.8.9.3 States shall ensure that the use of low power and higher rate DF = 19 operation (as per 3.1.2.8.9.2) is compliant with the following requirements:

- a) it is limited to formation or element lead aircraft engaged in formation flight, directing the messages toward wing and other lead aircraft through a directional antenna with a beamwidth of no more than 90 degrees; and
- b) the type of information contained in the DF = 19 message is limited to the same type of information in the DF = 17 message, that is, information for the sole purpose of safety-of-flight.

Note.— This low-power, higher squitter rate capability is intended for limited use by State aircraft in coordination with appropriate regulatory bodies.

3.1.2.8.9.4 All UF = 19 airborne interrogations shall be included in the interference control provisions of 4.3.2.2.2.2.

3.1.2.9 AIRCRAFT IDENTIFICATION PROTOCOL

3.1.2.9.1 *Aircraft identification reporting.* A ground-initiated Comm-B request (3.1.2.6.11.2) containing RR equals 18 and either DI does not equal 7 or DI equals 7 and RRS equals 0 shall cause the resulting reply to contain the aircraft identification in its MB field.

3.1.2.9.1.1 *AIS, aircraft identification subfield in MB.* The transponder shall report the aircraft identification in the 48-bit (41-88) AIS subfield of MB. The aircraft identification transmitted shall be that employed in the flight plan. When no flight plan is available, the registration marking of the aircraft shall be inserted in this subfield.

Note.— When the registration marking of the aircraft is used, it is classified as “fixed direct data” (3.1.2.10.5.1.1). When another type of aircraft identification is used, it is classified as “variable direct data” (3.1.2.10.5.1.3).

3.1.2.9.1.2 *Coding of the AIS subfield.* The AIS subfield shall be coded as follows:

33	41	47	53	59	65	71	77	83
BDS	Char. 1	Char. 2	Char. 3	Char. 4	Char. 5	Char. 6	Char. 7	Char. 8
40	46	52	58	64	70	76	82	88

Note.— Aircraft identification coding provides up to eight characters.

The BDS code for the aircraft identification message shall be BDS1 equals 2 (33-36) and BDS2 equals 0 (37-40).

Each character shall be coded as a 6-bit subset of the International Alphabet Number 5 (IA-5) as illustrated in Table 3-8. The character code shall be transmitted with the high order unit (b_6) first and the reported aircraft identification shall be transmitted with its left-most character first. Characters shall be coded consecutively without intervening SPACE code. Any unused character spaces at the end of the subfield shall contain a SPACE character code.

3.1.2.9.1.3 *Aircraft identification capability report.* Transponders which respond to a ground-initiated request for aircraft identification shall report this capability in the data link capability report (3.1.2.6.10.2.2.2) by setting bit 33 of the MB subfield to 1.

3.1.2.9.1.4 *Change of aircraft identification.* If the aircraft identification reported in the AIS subfield is changed in flight, the transponder shall report the new identification to the ground by use of the Comm-B broadcast message protocol of 3.1.2.6.11.4 for BDS1 = 2 (33 - 36) and BDS2 = 0 (37 - 40). The transponder shall initiate, generate and announce the revised aircraft identification even if the interface providing flight identification is lost. The transponder shall ensure that the BDS code is set for the aircraft identification report in all cases, including a loss of the interface. In this latter case, bits 41 - 88 shall contain all ZEROs.

Note.— The setting of the BDS code by the transponder ensures that a broadcast change of aircraft identification will contain the BDS code for all cases of flight identification failure (e.g. the loss of the interface providing flight identification).

3.1.2.10 ESSENTIAL SYSTEM CHARACTERISTICS OF THE SSR MODE S TRANSPONDER

3.1.2.10.1 *Transponder sensitivity and dynamic range.* Transponder sensitivity shall be defined in terms of a given interrogation signal input level and a given percentage of corresponding replies. Only correct replies containing the required bit pattern for the interrogation received shall be counted. Given an interrogation that requires a reply according to 3.1.2.4, the minimum triggering level, MTL, shall be defined as the minimum input power level for 90 per cent reply-to-interrogation ratio. The MTL shall be $-74 \text{ dBm} \pm 3 \text{ dB}$ for Mode S interrogations (interrogations using P_6), and as defined in 3.1.1.7.5.1 b) for Mode A and C, and inter-mode interrogations. The reply-to-interrogation ratio of a Mode S transponder shall be:

- a) at least 99 per cent for signal input levels between 3 dB above MTL and -21 dBm ; and
- b) no more than 10 per cent at signal input levels below -81 dBm .

Note.— *Transponder sensitivity and output power are described in this section in terms of signal level at the terminals of the antenna. This gives the designer freedom to arrange the installation, optimizing cable length and receiver-transmitter design, and does not exclude receiver and/or transmitter components from becoming an integral part of the antenna subassembly.*

3.1.2.10.1.1 *Reply ratio in the presence of interference*

Note.— *The following paragraphs present measures of the performance of the Mode S transponder in the presence of interfering Mode A/C interrogation pulses and low-level in-band CW interference.*

3.1.2.10.1.1.1 *Reply ratio in the presence of an interfering pulse.* Given a Mode S interrogation which requires a reply (3.1.2.4), the reply ratio of a transponder shall be at least 95 per cent in the presence of an interfering Mode A/C interrogation pulse if the level of the interfering pulse is 6 dB or more below the signal level for Mode S input signal levels between -68 dBm and -21 dBm and the interfering pulse overlaps the P_6 pulse of the Mode S interrogation anywhere after the sync phase reversal.

Under the same conditions, the reply ratio shall be at least 50 per cent if the interference pulse level is 3 dB or more below the signal level.

3.1.2.10.1.1.2 *Reply ratio in the presence of pulse pair interference.* Given an interrogation which requires a reply (3.1.2.4), the reply ratio of a transponder shall be at least 90 per cent in the presence of an interfering $P_1 - P_2$ pulse pair if the level of the interfering pulse pair is 9 dB or more below signal level for input signal levels between -68 dBm and -21 dBm and the P_1 pulse of the interfering pair occurs no earlier than the P_1 pulse of the Mode S signal.

3.1.2.10.1.1.3 *Reply ratio in the presence of low level asynchronous interference.* For all received signals between -65 dBm and -21 dBm and given a Mode S interrogation that requires a reply according to 3.1.2.4 and if no lockout condition is in effect, the transponder shall reply correctly with at least 95 per cent reply ratio in the presence of asynchronous interference. Asynchronous interference shall be taken to be a single Mode A/C interrogation pulse occurring at all repetition rates up to 10 000 Hz at a level 12 dB or more below the level of the Mode S signal.

Note.— *Such pulses may combine with the P_1 and P_2 pulses of the Mode S interrogation to form a valid Mode A/C-only all-call interrogation. The Mode S transponder does not respond to Mode A/C-only all-call interrogations. A preceding pulse may also combine with the P_2 of the Mode S interrogation to form a valid Mode A or Mode C interrogation. However, the $P_1 - P_2$ pair of the Mode S preamble takes precedence (3.1.2.4.1.1.1). The Mode S decoding process is independent of the Mode A/Mode C decoding process and the Mode S interrogation is accepted.*

3.1.2.10.1.1.4 *Reply ratio in the presence of low-level in-band CW interference.* In the presence of non-coherent CW interference at a frequency of $1\,030 \pm 0.2$ MHz at signal levels of 20 dB or more below the desired Mode A/C or Mode S interrogation signal level, the transponder shall reply correctly to at least 90 per cent of the interrogations.

3.1.2.10.1.1.5 *Spurious response*

3.1.2.10.1.1.5.1 **Recommendation.**— *The response to signals not within the receiver pass band should be at least 60 dB below normal sensitivity.*

3.1.2.10.1.1.5.2 For transponder designs first certified on or after 1 January 2011, the spurious Mode A/C reply ratio resulting from low level Mode S interrogations shall be no more than:

- a) an average of 1 per cent in the input interrogation signal range between -81 dBm and the Mode S MTL; and
- b) a maximum of 3 per cent at any given level in the input interrogation signal range between -81 dBm and the Mode S MTL.

Note 1.— *Failure to detect a low level Mode S interrogation can also result in the transponder decoding a three-pulse Mode A/C/S all-call interrogation. This would result in the transponder responding with a Mode S all-call (DF = 11) reply. The above requirement will also control these DF = 11 replies since it places a limit on the probability of failing to correctly detect the Mode S interrogation.*

Note 2.— *More information about issuing a type certificate for aircraft and separate design approval can be found in the Airworthiness Manual (Doc 9760).*

3.1.2.10.2 *Transponder peak pulse power.* The peak power of each pulse of a reply shall:

- a) not be less than 18.5 dBW for aircraft not capable of operating at altitudes exceeding 4 570 m (15 000 ft);
- b) not be less than 21.0 dBW for aircraft capable of operating above 4 570 m (15 000 ft);
- c) not be less than 21.0 dBW for aircraft with maximum cruising speed exceeding 324 km/h (175 kt); and
- d) not exceed 27.0 dBW.

3.1.2.10.2.1 *Inactive state transponder output power.* When the transponder is in the inactive state the peak pulse power at 1 090 MHz plus or minus 3 MHz shall not exceed -50 dBm. The inactive state is defined to include the entire period between transmissions less 10-microsecond transition periods preceding the first pulse and following the last pulse of the transmission.

Note.— *Inactive state transponder power is constrained in this way to ensure that an aircraft, when located as near as 185 m (0.1 NM) to a Mode A/C or Mode S interrogator, does not cause interference to that installation. In certain applications of Mode S, airborne collision avoidance for example, where a 1 090 MHz transmitter and receiver are in the same aircraft, it may be necessary to further constrain the inactive state transponder power.*

3.1.2.10.2.2 *Spurious emission radiation*

Recommendation.— *CW radiation should not exceed 70 dB below 1 watt.*

3.1.2.10.3 SPECIAL CHARACTERISTICS

3.1.2.10.3.1 Mode S side-lobe suppression

Note.— Side-lobe suppression for Mode S formats occurs when a P_5 pulse overlays the location of the sync phase reversal of P_6 , causing the transponder to fail to recognize the interrogation (3.1.2.4.1.1.3).

Given a Mode S interrogation that requires a reply, the transponder shall:

- a) at all signal levels between MTL +3 dB and –21 dBm, have a reply ratio of less than 10 per cent if the received amplitude of P_5 exceeds the received amplitude of P_6 by 3 dB or more;
- b) at all signal levels between MTL +3 dB and –21 dBm, have a reply ratio of at least 99 per cent if the received amplitude of P_6 exceeds the received amplitude of P_5 by 12 dB or more.

3.1.2.10.3.2 *Mode S dead time.* Dead time shall be defined as the time interval beginning at the end of a reply transmission and ending when the transponder has regained sensitivity to within 3 dB of MTL. Mode S transponders shall not have more than 125 microseconds' dead time.

3.1.2.10.3.3 *Mode S receiver desensitization.* The transponder's receiver shall be desensitized according to 3.1.1.7.7.1 on receipt of any pulse of more than 0.7 microseconds duration.

3.1.2.10.3.3.1 *Recovery from desensitization.* Recovery from desensitization shall begin at the trailing edge of each pulse of a received signal and shall occur at the rate prescribed in 3.1.1.7.7.2, provided that no reply or data transfer is made in response to the received signal.

3.1.2.10.3.4 Recovery after Mode S interrogations that do not elicit replies

3.1.2.10.3.4.1 Recovery after a single Mode S interrogation

3.1.2.10.3.4.1.1 The transponder shall recover sensitivity to within 3 dB of MTL no later than 128 microseconds after receipt of the sync phase reversal following a Mode S interrogation that is not accepted (3.1.2.4.1.2) or that is accepted but requires no reply.

3.1.2.10.3.4.1.2 **Recommendation.**— *The transponder should recover sensitivity to within 3 dB of MTL no later than 45 microseconds after receipt of the sync phase reversal following a Mode S interrogation that is not accepted (3.1.2.4.1.2) or that is accepted but requires no reply.*

3.1.2.10.3.4.1.3 All Mode S transponders installed on or after 1 January 1999 shall recover sensitivity to within 3 dB of MTL no later than 45 microseconds after receipt of the sync phase reversal following a Mode S interrogation that is not accepted (3.1.2.4.1.2) or that is accepted but requires no reply.

3.1.2.10.3.4.2 *Recovery after a Mode S Comm-C interrogation.* A Mode S transponder with Comm-C capability shall recover sensitivity to within 3 dB of MTL no later than 45 microseconds after receipt of the sync phase reversal following acceptance of a Comm-C interrogation for which no reply is required.

3.1.2.10.3.5 *Unwanted Mode S replies.* Mode S transponders shall not generate unwanted Mode S replies more often than once in 10 seconds. Installation in the aircraft shall be made in such a manner that this standard shall be achieved when all possible interfering equipments installed in the same aircraft are operating at maximum interference levels.

3.1.2.10.3.5.1 *Unwanted Mode S replies in the presence of low-level in-band CW interference.* In the presence of non-coherent CW interference at a frequency of $1\ 030 \pm 0.2$ MHz and at signal levels of -60 dBm or less, and in the absence of valid interrogation signals, Mode S transponders shall not generate unwanted Mode S replies more often than once per 10 seconds.

3.1.2.10.3.6 *Reply rate limiting*

Note.— Reply rate limiting is prescribed separately for Modes A and C and for Mode S.

3.1.2.10.3.6.1 *Mode S reply rate limiting.* Reply rate limiting is not required for the Mode S formats of a transponder. If such limiting is incorporated for circuit protection, it shall permit the minimum reply rates required in 3.1.2.10.3.7.2 and 3.1.2.10.3.7.3.

3.1.2.10.3.6.2 *Modes A and C reply rate limiting.* Reply rate limiting for Modes A and C shall be effected according to 3.1.1.7.9.1. The prescribed sensitivity reduction (3.1.1.7.9.2) shall not affect the Mode S performance of the transponder.

3.1.2.10.3.7 *Minimum reply rate capability, Modes A, C and S*

3.1.2.10.3.7.1 All reply rates specified in 3.1.2.10.3.7 shall be in addition to any squitter transmissions that the transponder is required to make.

3.1.2.10.3.7.2 *Minimum reply rate capability, Modes A and C.* The minimum reply rate capability for Modes A and C shall be in accordance with 3.1.1.7.9.

3.1.2.10.3.7.3 *Minimum reply rate capability, Mode S.* A transponder capable of transmitting only short Mode S replies shall be able to generate replies at the following rates:

- 50 Mode S replies in any 1-second interval
- 18 Mode S replies in a 100-millisecond interval
- 8 Mode S replies in a 25-millisecond interval
- 4 Mode S replies in a 1.6-millisecond interval

In addition to any downlink ELM transmissions, a level 2, 3 or 4 transponder shall be able to generate as long replies at least:

- 16 of 50 Mode S replies in any 1-second interval
- 6 of 18 Mode S replies in a 100-millisecond interval
- 4 of 8 Mode S replies in a 25-millisecond interval
- 2 of 4 Mode S replies in a 1.6-millisecond interval

Transponders used in conjunction with ACAS shall be able to generate as long replies at least:

- 60 Mode S replies in any 1-second interval
- 6 of 18 Mode S replies in a 100-millisecond interval
- 4 of 8 Mode S replies in a 25-millisecond interval
- 2 of 4 Mode S replies in a 1.6-millisecond interval

In addition to downlink ELM transmissions, a level 5 transponder shall be able to generate as long replies at least:

- 24 of 50 Mode S replies in any 1-second interval
- 9 of 18 Mode S replies in a 100-millisecond interval
- 6 of 8 Mode S replies in a 25-millisecond interval
- 2 of 4 Mode S replies in a 1.6-millisecond interval

3.1.2.10.3.7.4 *Minimum Mode S ELM peak reply rate*

Note 1.— When a downlink ELM is initialized (3.1.2.7.7.1), the Mode S transponder announces the length (in segments) of the waiting message. The transponder must be able to transmit this number of segments, plus an additional margin to make up for missed replies, during the beam dwell of the ground interrogator.

At least once every second a Mode S transponder equipped for ELM downlink operation shall be capable of transmitting in a 25-millisecond interval, at least 25 per cent more segments than have been announced in the initialization (3.1.2.7.7.1). The minimum length downlink ELM capability for level 4 and 5 transponders shall be as specified in 3.1.2.10.5.2.2.2.

Note 2.— A transponder capable of processing the maximum length downlink ELM (16 segments) is therefore required to be able to transmit 20 long replies under the above conditions. Level 4 transponders may be built which process less than the maximum message length. These transponders cannot initialize a message length that exceeds their transmitter capability. For example, a transponder that can transmit at most 10 long replies under the above conditions can never announce a message of more than 8 segments.

3.1.2.10.3.8 *Reply delay and jitter*

Note.— After an interrogation has been accepted and if a reply is required, this reply transmission begins after a fixed delay needed to carry out the protocols. Different values for this delay are assigned for Modes A and C, for Mode S and for Modes A/C/S all-call replies.

3.1.2.10.3.8.1 *Reply delay and jitter for Modes A and C.* The reply delay and jitter for Modes A and C transactions shall be as prescribed in 3.1.1.7.10.

3.1.2.10.3.8.2 *Reply delay and jitter for Mode S.* For all input signal levels between MTL and -21 dBm, the leading edge of the first preamble pulse of the reply (3.1.2.2.5.1.1) shall occur 128 plus or minus 0.25 microsecond after the sync phase reversal (3.1.2.1.5.2.2) of the received P_6 . The jitter of the reply delay shall not exceed 0.08 microsecond, peak (99.9 percentile).

3.1.2.10.3.8.3 *Reply delay and jitter for Modes A/C/S all call.* For all input signal levels between MTL +3 dB and -21 dBm the leading edge of the first preamble pulse of the reply (3.1.2.2.5.1.1) shall occur 128 plus or minus 0.5 microseconds after the leading edge of the P_4 pulse of the interrogation (3.1.2.1.5.1.1). Jitter shall not exceed 0.1 microsecond, peak (99.9 percentile).

Note.— A peak jitter of 0.1 microsecond is consistent with the jitter prescribed in 3.1.1.7.10.

3.1.2.10.3.9 *Timers.* Duration and features of timers shall be as shown in Table 3-9. All timers shall be capable of being restarted. On receipt of any start command, they shall run for their specified times. This shall occur regardless of whether they are in the running or the non-running state at the time that the start command is received. A command to reset a timer shall cause the timer to stop running and to return to its initial state in preparation for a subsequent start command.

3.1.2.10.3.10 *Inhibition of replies.* Replies to Mode A/C/S all-call and Mode S-only all-call interrogations shall always be inhibited when the aircraft declares the on-the-ground state. It shall not be possible to inhibit replies to discretely addressed Mode S interrogations regardless of whether the aircraft is airborne or on the ground.

3.1.2.10.3.10.1 **Recommendation.**— *Aircraft should provide means to determine the on-the-ground state automatically and provide that information to the transponder.*

3.1.2.10.3.10.2 **Recommendation.**— *Mode A/C replies should be inhibited when the aircraft is on the ground to prevent interference when in close proximity to an interrogator or other aircraft.*

Note.— Mode S discretely addressed interrogations do not give rise to such interference and may be required for data link communications with aircraft on the airport surface. Acquisition squitter transmissions may be used for passive surveillance of aircraft on the airport surface.

3.1.2.10.4 *Transponder antenna system and diversity operation.* Mode S transponders equipped for diversity operation shall have two RF ports for operation with two antennas, one antenna on the top and the other on the bottom of the aircraft's fuselage. The received signal from one of the antennas shall be selected for acceptance and the reply shall be transmitted from the selected antenna only.

3.1.2.10.4.1 *Radiation pattern.* The radiation pattern of Mode S antennas when installed on an aircraft shall be nominally equivalent to that of a quarter-wave monopole on a ground plane.

Note.— Transponder antennas designed to increase gain at the expense of vertical beamwidth are undesirable because of their poor performance during turns.

3.1.2.10.4.2 *Antenna location.* The top and bottom antennas shall be mounted as near as possible to the centre line of the fuselage. Antennas shall be located so as to minimize obstruction to their fields in the horizontal plane.

3.1.2.10.4.2.1 **Recommendation.**— *The horizontal distance between the top and bottom antennas should not be greater than 7.6 m (25 ft).*

Note.— *This recommendation is intended to support the operation of any diversity transponder (including cables) with any diversity antenna installation and still satisfy the requirement of 3.1.2.10.4.5.*

3.1.2.10.4.3 *Antenna selection.* Mode S transponders equipped for diversity operation shall have the capability to evaluate a pulse sequence simultaneously received on both antenna channels to determine individually for each channel if the P_1 pulse and the P_2 pulse of a Mode S interrogation preamble meet the requirements for a Mode S interrogation as defined in 3.1.2.1 and if the P_1 pulse and the P_3 pulse of a Mode A, Mode C or intermode interrogation meet the requirements for Mode A and Mode C interrogations as defined in 3.1.1.

Note.— *Transponders equipped for diversity operation may optionally have the capability to evaluate additional characteristics of the received pulses of the interrogations in making a diversity channel selection. The transponder may as an option evaluate a complete Mode S interrogation simultaneously received on both channels to determine individually for each channel if the interrogation meets the requirements for Mode S interrogation acceptance as defined in 3.1.2.4.1.2.3.*

3.1.2.10.4.3.1 If the two channels simultaneously receive at least a $P_1 - P_2$ pulse pair that meets the requirements for a Mode S interrogation, or a $P_1 - P_3$ pulse pair that meets the requirements for a Mode A or Mode C interrogation, or if the two channels simultaneously accept a complete interrogation, the antenna at which the signal strength is greater shall be selected for the reception of the remainder (if any) of the interrogation and for the transmission of the reply.

3.1.2.10.4.3.2 If only one channel receives a pulse pair that meets the requirements for an interrogation, or if only one channel accepts an interrogation, the antenna associated with that channel shall be selected regardless of received signal strength.

3.1.2.10.4.3.3 *Selection threshold.* If antenna selection is based on signal level, it shall be carried out at all signal levels between MTL and -21 dBm.

Note.— *Either antenna may be selected if the difference in signal level is less than 3 dB.*

3.1.2.10.4.3.4 *Received signal delay tolerance.* If an interrogation is received at one antenna 0.125 microsecond or less in advance of reception at the other antenna, the interrogations shall be considered to be simultaneous interrogations, and the above antenna selection criteria applied. If an accepted interrogation is received at either antenna 0.375 microsecond or more in advance of reception at the other antenna, the antenna selected for the reply shall be that which received the earlier

interrogation. If the relative time of receipt is between 0.125 and 0.375 microsecond, the transponder shall select the antenna for reply either on the basis of the simultaneous interrogation criteria or on the basis of the earlier time of arrival.

3.1.2.10.4.4 *Diversity transmission channel isolation.* The peak RF power transmitted from the selected antenna shall exceed the power transmitted from the non-selected antenna by at least 20 dB.

3.1.2.10.4.5 *Reply delay of diversity transponders.* The total two-way transmission difference in mean reply delay between the two antenna channels (including the differential delay caused by transponder-to-antenna cables and the horizontal distance along the aircraft centre line between the two antennas) shall not exceed 0.13 microsecond for interrogations of equal amplitude. This requirement shall hold for interrogation signal strengths between MTL +3 dB and -21 dBm. The jitter requirements on each individual channel shall remain as specified for non-diversity transponders.

Note.— This requirement limits apparent jitter caused by antenna switching and by cable delay differences.

3.1.2.10.5 DATA PROCESSING AND INTERFACES

3.1.2.10.5.1 *Direct data.* Direct data shall be those which are required for the surveillance protocol of the Mode S system.

3.1.2.10.5.1.1 *Fixed direct data.* Fixed direct data are data from the aircraft which do not change in flight and shall be:

- a) the aircraft address (3.1.2.4.1.2.3.1.1 and 3.1.2.5.2.2.2);
- b) the maximum airspeed (3.1.2.8.2.2); and
- c) the registration marking if used for flight identification (3.1.2.9.1.1).

3.1.2.10.5.1.2 Interfaces for fixed direct data

Recommendation.— *Interfaces from the transponder to the aircraft should be designed such that the values of the fixed direct data become a function of the aircraft installation rather than of the transponder configuration.*

Note.— *The intent of this recommendation is to encourage an interface technique which permits transponder exchange without manipulation of the transponder itself for setting the fixed direct data.*

3.1.2.10.5.1.3 *Variable direct data.* Variable direct data are data from the aircraft which can change in flight and shall be:

- a) the Mode C altitude code (3.1.2.6.5.4);
- b) the Mode A identity code (3.1.2.6.7.1);
- c) the on-the-ground condition (3.1.2.5.2.2.1, 3.1.2.6.5.1 and 3.1.2.8.2.1);
- d) the aircraft identification if different from the registration marking (3.1.2.9.1.1); and
- e) the SPI condition (3.1.2.6.10.1.3).

3.1.2.10.5.1.4 *Interfaces for variable direct data.*

3.1.2.10.5.1.4.1 A means shall be provided, while on the ground or during flight, for the SPI condition to be inserted by the pilot, without the entry or modification of other flight data.

3.1.2.10.5.1.4.2 A means shall be provided, while on the ground or during flight, for the Mode A identity code to be displayed to the pilot and modified without the entry or modification of other flight data.

3.1.2.10.5.1.4.3 For transponders of Level 2 and above, a means shall be provided, while on the ground or during flight, for the aircraft identification to be displayed to the pilot, and, when containing variable data (3.1.2.10.5.1.3 d)), to be modified without the entry or modification of other flight data.

Note.— *Implementation of the pilot action for entry of data will be as simple and efficient as possible in order to minimize the time required and reduce the possibility of errors in the data entry.*

3.1.2.10.5.1.4.4 Interfaces shall be included to accept the pressure-altitude and on-the-ground coding.

Note.— *A specific interface design for the variable direct data is not prescribed.*

3.1.2.10.5.2 *Indirect data*

Note.— *Indirect data are those which pass through the transponder in either direction but which do not affect the surveillance function.*

If origins and/or destinations of indirect data are not within the transponder's enclosure, interfaces shall be used for the necessary connections.

3.1.2.10.5.2.1 *The function of interfaces*

Note.— *Indirect data interfaces for standard transactions serve interrogations which require a reply and the broadcast function. Indirect data interfaces for ELM serve that system and require buffering and protocol circuitry within the transponder. Interface ports can be separate for each direction and for each service or can be combined in any manner.*

3.1.2.10.5.2.1.1 *Uplink standard length transaction interface.* The uplink standard length transaction interface shall transfer all bits of accepted interrogations, (with the possible exception of the AP field), except for UF = 0, 11 or 16.

Note.— *AP can also be transferred to aid in integrity implementation.*

3.1.2.10.5.2.1.2 *Downlink standard length transaction interface.* A transponder which transmits information originating in a peripheral device shall be able to receive bits or bit patterns for insertion at appropriate locations within the transmission. These locations shall not include those into which bit patterns generated internally by the transponder are inserted, nor the AP field of the reply. A transponder which transmits information using the Comm-B format shall have immediate access to requested data in the sense that the transponder shall respond to an interrogation with data requested by that interrogation.

Note.— *This requirement may be met in two ways:*

- a) *the transponder may have provisions for internal data and protocol buffering;*
- b) *the transponder may employ a "real time" interface which operates such that uplink data leave the transponder before the corresponding reply is generated and downlink data enter the transponder in time to be incorporated in the reply.*

3.1.2.10.5.2.1.3 *Extended length message interface*

Note.— The ELM interface extracts from, and enters into, the transponder the data exchanged between air and ground by means of the ELM protocol (3.1.2.7).

3.1.2.10.5.2.2 *Indirect data transaction rates*

3.1.2.10.5.2.2.1 *Standard length transactions.* A transponder equipped for information transfer to and from external devices shall be capable of processing the data of at least as many replies as prescribed for minimum reply rates in 3.1.2.10.3.7.2 and uplink data from interrogations being delivered at a rate of at least:

- 50 long interrogations in any 1-second interval
- 18 long interrogations in a 100-millisecond interval
- 8 long interrogations in a 25-millisecond interval
- 4 long interrogations in a 1.6-millisecond interval.

Note 1.— A transponder capable of reply rates higher than the minimum of 3.1.2.10.3.7.2 need not accept long interrogations after reaching the uplink data processing limits above.

Note 2.— The Mode S reply is the sole means of acknowledging receipt of the data content of a Mode S interrogation. Thus, if the transponder is capable of replying to an interrogation, the Mode S installation must be capable of accepting the data contained in that interrogation regardless of the timing between it and other accepted interrogations. Overlapping Mode S beams from several interrogators could lead to the requirement for considerable data processing and buffering. The minimum described here reduces data processing to a realistic level and the non-acceptance provision provides for notification to the interrogator that data will temporarily not be accepted.

3.1.2.10.5.2.2.2 *Extended length transactions.* Level 3 (2.1.5.1.3) and level 4 (2.1.5.1.4) transponders shall be able to transfer data from at least four complete sixteen segment uplink ELMs (3.1.2.7.4) in any four second interval. A level 5 transponder (2.1.5.1.5) shall be able to transfer the data from at least four complete sixteen segment uplink ELMs in any one second interval and shall be capable of accepting at least two complete sixteen segment uplink ELMs with the same II code in a 250 millisecond interval. A level 4 transponder shall be able to transmit at least one four-segment downlink ELM (3.1.2.7.7 and 3.1.2.10.3.7.3) in any one second interval. A level 5 transponder shall be able to transmit at least one sixteen segment downlink ELM in any one second interval.

3.1.2.10.5.2.2.2.1 **Recommendation.**— Level 3 and level 4 transponders should be able to accept at least two complete sixteen segment uplink ELMs in a 250 millisecond interval.

3.1.2.10.5.2.3 *Data formats for standard length transactions and required downlink aircraft parameters (DAPs)*

3.1.2.10.5.2.3.1 All level 2 and above transponders shall support the following registers:

- the capability reports (3.1.2.6.10.2);
- the aircraft identification protocol register 20 {HEX} (3.1.2.9); and
- for ACAS-equipped aircraft, the active resolution advisory register 30 {HEX} (4.3.8.4.2.2).

3.1.2.10.5.2.3.2 Where required, DAPs shall be supported by the registers listed in Table 3-10. The formats and minimum update rates of transponder registers shall be implemented consistently to ensure interoperability.

3.1.2.10.5.2.3.3 The downlink standard length transaction interface shall deliver downlink aircraft parameters (DAPs) to the transponder which makes them available to the ground. Each DAP shall be packed into the Comm-B format ('MB' field) and can be extracted using either the ground-initiated Comm-B (GICB) protocol, or using MSP downlink channel 3 via the dataflash application.

Note.— *The formats and update rates of each register and the dataflash application are specified in the Technical Provisions for Mode S Services and Extended Squitter (Doc 9871).*

3.1.2.10.5.3 *Integrity of data content transfer.* A transponder which employs data interfaces shall include sufficient protection to ensure error rates of less than one error in 10^3 messages and less than one undetected error in 10^7 112-bit transmissions in both directions between the antenna and each interface port.

3.1.2.10.5.4 *Message cancellation.* The downlink standard length transaction interface and the extended length message interface shall include the capability to cancel a message sent to the transponder for delivery to the ground, but whose delivery cycle has not been completed (i.e. a closeout has not been accomplished by a ground interrogator).

Note.— *One example of the need for this capability is to cancel a message if delivery is attempted when the aircraft is not within coverage of a Mode S ground station. The message must then be cancelled to prevent it from being read and interpreted as a current message when the aircraft re-enters Mode S airspace.*

3.1.2.10.5.5 *Air-directed messages.* The transfer of this type of message requires all of the actions indicated in 3.1.2.10.5.4 plus the transfer to the transponder of the interrogator identifier of the site that is to receive the message.

3.1.2.11 ESSENTIAL SYSTEM CHARACTERISTICS OF THE GROUND INTERROGATOR

Note.— *To ensure that Mode S interrogator action is not detrimental to Mode A/C interrogators, performance limits exist for Mode S interrogators.*

3.1.2.11.1 *Interrogation repetition rates.* Mode S interrogators shall use the lowest practicable interrogation repetition rates for all interrogation modes.

Note.— *Accurate azimuth data at low interrogation rates can be obtained with monopulse techniques.*

3.1.2.11.1.1 *All-call interrogation repetition rate*

3.1.2.11.1.1.1 The interrogation repetition rate for the Mode A/C/S all-call, used for acquisition, shall be less than 250 per second. This rate shall also apply to the paired Mode S-only and Mode A/C-only all-call interrogations used for acquisition in the multisite mode.

3.1.2.11.1.1.2 *Maximum number of Mode S all-call replies triggered by an interrogator.* For aircraft that are not locked out, a Mode S interrogator shall not trigger, on average, more than 6 Mode S all-call replies per period of 200 ms and no more than 26 Mode S all-call replies counted over a period of 18 seconds.

3.1.2.11.1.2 *Interrogation repetition rate to a single aircraft*

3.1.2.11.1.2.1 *Interrogations requiring a reply.* Mode S interrogations requiring a reply shall not be transmitted to a single aircraft at intervals shorter than 400 microseconds.

3.1.2.11.1.2.2 *Uplink ELM interrogations.* The minimum time between the beginning of successive Comm-C interrogations shall be 50 microseconds.

3.1.2.11.1.3 *Transmission rate for selective interrogations*

3.1.2.11.1.3.1 For all Mode S interrogators, the transmission rate for selective interrogations shall be:

- a) less than 2 400 per second averaged over a 40-millisecond interval; and
- b) less than 480 into any 3-degree sector averaged over a 1-second interval.

3.1.2.11.1.3.2 Additionally, for a Mode S interrogator that has overlapping coverage with the sidelobes of any other Mode S interrogator, the transmission rate for selective interrogations shall be:

- a) less than 1 200 per second averaged over a 4-second interval; and
- b) less than 1 800 per second averaged over a 1-second interval.

Note.— Typical minimum distance to ensure sidelobe separation between interrogators is 35 km.

3.1.2.11.2 *INTERROGATOR-EFFECTIVE RADIATED POWER*

Recommendation.— *The effective radiated power of all interrogation pulses should be minimized as described in 3.1.1.8.2.*

3.1.2.11.3 *Inactive-state interrogator output power.* When the interrogator transmitter is not transmitting an interrogation, its output shall not exceed -5 dBm effective radiated power at any frequency between 960 MHz and 1 215 MHz.

Note.— *This constraint ensures that aircraft flying near the interrogator (as close as 1.85 km (1 NM)) will not receive interference that would prevent them from being tracked by another interrogator. In certain instances even smaller interrogator-to-aircraft distances are of significance, for example if Mode S surveillance on the airport surface is used. In such cases a further restraint on inactive state interrogator output power may be necessary.*

3.1.2.11.3.1 *Spurious emission radiation*

Recommendation.— *CW radiation should not exceed 76 dB below 1 watt.*

3.1.2.11.4 *Tolerances on transmitted signals.* In order that the signal-in-space be received by the transponder as described in 3.1.2.1, the tolerances on the transmitted signal shall be as summarized in Table 3-11.

3.1.2.11.5 *SPURIOUS RESPONSE*

Recommendation.— *The response to signals not within the passband should be at least 60 dB below normal sensitivity.*

3.1.2.11.6 *Lockout coordination.* A Mode S interrogator shall not be operated using all-call lockout until coordination has been achieved with all other operating Mode S interrogators having any overlapping coverage volume in order to ensure that no interrogator can be denied the acquisition of Mode S-equipped aircraft.

Note.— *This coordination may be via ground network or by the allocation of interrogator identifier (II) codes and will involve regional agreements where coverage overlaps international boundaries.*

3.1.2.11.7 MOBILE INTERROGATORS

Recommendation.— Mobile interrogators should acquire, whenever possible, Mode S aircraft through the reception of squitters.

Note.— Passive squitter acquisition reduces channel loading and can be accomplished without the need for coordination.

TABLES FOR CHAPTER 3

Table 3-1. Pulse shapes — Mode S and intermode interrogations

Pulse	Duration	Duration tolerance	(Rise time)		(Decay time)	
			Min.	Max.	Min.	Max.
P_1, P_2, P_3, P_5	0.8	±0.1	0.05	0.1	0.05	0.2
P_4 (short)	0.8	±0.1	0.05	0.1	0.05	0.2
P_4 (long)	1.6	±0.1	0.05	0.1	0.05	0.2
P_6 (short)	16.25	±0.25	0.05	0.1	0.05	0.2
P_6 (long)	30.25	±0.25	0.05	0.1	0.05	0.2
S_1	0.8	±0.1	0.05	0.1	0.05	0.2

Table 3-2. Pulse shapes — Mode S replies

Pulse duration	Duration tolerance	(Rise time)		(Decay time)	
		Min.	Max.	Min.	Max.
0.5	±0.05	0.05	0.1	0.05	0.2
1.0	±0.05	0.05	0.1	0.05	0.2

Table 3-3. Field definitions

Field		Format		Reference
Designator	Function	UF	DF	
AA	Address announced		11, 17, 18	3.1.2.5.2.2.2
AC	Altitude code		4, 20	3.1.2.6.5.4
AF	Application field		19	3.1.2.8.8.2
AP	Address/parity	All	0, 4, 5, 16, 20, 21, 24	3.1.2.3.2.1.3
AQ	Acquisition	0		3.1.2.8.1.1
CA	Capability		11, 17	3.1.2.5.2.2.1
CC	Cross-link capability		0	3.1.2.8.2.3
CF	Control field		18	3.1.2.8.7.2
CL	Code label	11		3.1.2.5.2.1.3
DF	Downlink format		All	3.1.2.3.2.1.2

<i>Field</i>		<i>Format</i>		<i>Reference</i>
<i>Designator</i>	<i>Function</i>	<i>UF</i>	<i>DF</i>	
DI	Designator identification	4, 5, 20, 21		3.1.2.6.1.3
DP	Data parity		20, 21	3.1.2.3.2.1.5
DR	Downlink request		4, 5, 20, 21	3.1.2.6.5.2
DS	Data selector	0		3.1.2.8.1.3
FS	Flight status		4, 5, 20, 21	3.1.2.6.5.1
IC	Interrogator code	11		3.1.2.5.2.1.2
ID	Identity		5, 21	3.1.2.6.7.1
KE	Control, ELM		24	3.1.2.7.3.1
MA	Message, Comm-A	20, 21		3.1.2.6.2.1
MB	Message, Comm-B		20, 21	3.1.2.6.6.1
MC	Message, Comm-C	24		3.1.2.7.1.3
MD	Message, Comm-D		24	3.1.2.7.3.3
ME	Message, extended squitter		17, 18	3.1.2.8.6.2
MU	Message, ACAS	16		4.3.8.4.2.3
MV	Message, ACAS		16	3.1.2.8.3.1, 4.3.8.4.2.4
NC	Number of C-segment	24		3.1.2.7.1.2
ND	Number of D-segment		24	3.1.2.7.3.2
PC	Protocol	4, 5, 20, 21		3.1.2.6.1.1
PI	Parity/interrogator identifier		11, 17, 18	3.1.2.3.2.1.4
PR	Probability of reply	11		3.1.2.5.2.1.1
RC	Reply control	24		3.1.2.7.1.1
RI	Reply information		0	3.1.2.8.2.2
RL	Reply length	0		3.1.2.8.1.2
RR	Reply request	4, 5, 20, 21		3.1.2.6.1.2
SD	Special designator	4, 5, 20, 21		3.1.2.6.1.4
SL	Sensitivity Level (ACAS)		0, 16	4.3.8.4.2.5
UF	Uplink format	All		3.1.2.3.2.1.1
UM	Utility message		4, 5, 20, 21	3.1.2.6.5.3
VS	Vertical status		0	3.1.2.8.2.1

Table 3-4. Subfield definitions

<i>Subfield</i>			
<i>Designator</i>	<i>Function</i>	<i>Field</i>	<i>Reference</i>
ACS	Altitude code subfield	ME	3.1.2.8.6.3.1.2
AIS	Aircraft identification subfield	MB	3.1.2.9.1.1
ATS	Altitude type subfield	MB	3.1.2.8.6.8.2
BDS 1	Comm-B data selector subfield 1	MB	3.1.2.6.11.2.1
BDS 2	Comm-B data selector subfield 2	MB	3.1.2.6.11.2.1
IDS	Identifier designator subfield	UM	3.1.2.6.5.3.1
IIS	Interrogator identifier subfield	SD	3.1.2.6.1.4.1 a)
		UM	3.1.2.6.5.3.1
LOS	Lockout subfield	SD	3.1.2.6.1.4.1 d)
LSS	Lockout surveillance subfield	SD	3.1.2.6.1.4.1 g)
MBS	Multisite Comm-B subfield	SD	3.1.2.6.1.4.1 c)
MES	Multisite ELM subfield	SD	3.1.2.6.1.4.1 c)
OVC	Overlay control	SD	3.1.2.6.1.4.1 i)
RCS	Rate control subfield	SD	3.1.2.6.1.4.1 f)
RRS	Reply request subfield	SD	3.1.2.6.1.4.1 e) and g)
RSS	Reservation status subfield	SD	3.1.2.6.1.4.1 c)
SAS	Surface antenna subfield	SD	3.1.2.6.1.4.1 f)
SCS	Squitter capability subfield	MB	3.1.2.6.10.2.2.1
SIC	Surveillance identifier capability	MB	3.1.2.6.10.2.2.1
SIS	Surveillance identifier subfield	SD	3.1.2.6.1.4.1 g)
SRS	Segment request subfield	MC	3.1.2.7.7.2.1
SSS	Surveillance status subfield	ME	3.1.2.8.6.3.1.1
TAS	Transmission acknowledgement subfield	MD	3.1.2.7.4.2.6
TCS	Type control subfield	SD	3.1.2.6.1.4.1 f)
TMS	Tactical message subfield	SD	3.1.2.6.1.4.1 d)
TRS	Transmission rate subfield	MB	3.1.2.8.6.8.1

Table 3-5. Interrogation — reply protocol summary

<i>Interrogation UF</i>	<i>Special conditions</i>	<i>Reply DF</i>
0	RL (3.1.2.8.1.2) equals 0 RL (3.1.2.8.1.2) equals 1	0 16
4	RR (3.1.2.6.1.2) less than 16 RR (3.1.2.6.1.2) equal to or greater than 16	4 20
5	RR (3.1.2.6.1.2) less than 16 RR (3.1.2.6.1.2) equal to or greater than 16	5 21
11	Transponder locked out to interrogator code, IC (3.1.2.5.2.1.2) Stochastic reply test fails (3.1.2.5.4) Otherwise	No reply No reply 11
20	RR (3.1.2.6.1.2) less than 16 RR (3.1.2.6.1.2) equal to or greater than 16 AP contains broadcast address (3.1.2.4.1.2.3.1.3)	4 20 No reply
21	RR (3.1.2.6.1.2) less than 16 RR (3.1.2.6.1.2) equal to or greater than 16 AP contains broadcast address (3.1.2.4.1.2.3.1.3)	5 21 No reply
24	RC (3.1.2.7.1.1) equals 0 or 1 RC (3.1.2.7.1.1) equals 2 or 3	No reply 24

Table 3-6. Table for register 10₁₆

<i>Subfields of register 10₁₆</i>	<i>MB bits</i>	<i>Comm-B bits</i>
Continuation flag	9	41
Overlay command capability	15	47
ACAS capability	16 and 37-40	48 and 69-72
Mode S subnetwork version number	17-23	49-55
Transponder enhanced protocol indicator	24	56
Specific services capability	25	57
Uplink ELM capability	26-28	58-60
Downlink ELM capability	29-32	61-64
Aircraft identification capability	33	65
Squitter capability subfield (SCS)	34	66
Surveillance identifier code capability (SIC)	35	67
Common usage GICB capability report	36	68
Status of DTE sub-addresses 0 to 15	41-56	73-88

Table 3-7. Surface format broadcast without an automatic means of on-the-ground determination

<i>ADS-B Emitter Category set "A"</i>						
<i>Coding</i>	<i>Meaning</i>	<i>Ground Speed</i>		<i>Airspeed</i>		<i>Radio Altitude</i>
0	No ADS-B emitter category information	Always report airborne position message (3.1.2.8.6.3.1)				
1	Light (<15 500 lbs or 7 031 kg)	Always report airborne position message (3.1.2.8.6.3.1)				
2	Small (15 500 to 75 000 lbs or 7 031 to 34 019 kg)	< 100 knots	and	<100 knots	and	<50 feet
3	Large (75 000 lbs to 300 000 lbs or 34 019 to 136 078 kg)	<100 knots	and	<100 knots	and	<50 feet
4	High-vortex aircraft	<100 knots	and	<100 knots	and	<50 feet
5	Heavy (> 300 000 lbs or 136 078 kg)	<100 knots	and	<100 knots	and	<50 feet
6	High performance (>5g acceleration and >400 knots)	<100 knots	and	<100 knots	and	<50 feet
7	Rotorcraft	Always report airborne position message (3.1.2.8.6.3.1)				
<i>ADS-B Emitter Category Set "B"</i>						
<i>Coding</i>	<i>Meaning</i>	<i>Ground Speed</i>		<i>Airspeed</i>		<i>Radio Altitude</i>
0	No ADS-B emitter category information	Always report airborne position message (3.1.2.8.6.3.1)				
1	Glider/sailplane	Always report airborne position message (3.1.2.8.6.3.1)				
2	Lighter-than-air	Always report airborne position message (3.1.2.8.6.3.1)				
3	Parachutist/skydiver	Always report airborne position message (3.1.2.8.6.3.1)				
4	Ultra-light/hang-glider/paraglider	Always report airborne position message (3.1.2.8.6.3.1)				
5	Reserved	Reserved				
6	Unmanned aerial vehicle	Always report airborne position message (3.1.2.8.6.3.1)				
7	Space/trans-atmospheric vehicle	<100 knots	and	<100 knots	and	<50 feet
<i>ADS-B Emitter Category Set "C"</i>						
<i>Coding</i>	<i>Meaning</i>					
0	No ADS-B emitter category information	Always report airborne position message (3.1.2.8.6.3.1)				
1	Surface vehicle – emergency vehicle	Always report surface position message (3.1.2.8.6.3.2)				
2	Surface vehicle - service vehicle	Always report surface position message (3.1.2.8.6.3.2)				
3	Fixed ground or tethered obstruction	Always report airborne position message (3.1.2.8.6.3.1)				
4 – 7	Reserved	Reserved				
<i>ADS-B Emitter Category Set "D"</i>						
<i>Coding</i>	<i>Meaning</i>					
0	No ADS-B emitter category information	Always report airborne position message (3.1.2.8.6.3.1)				
1 – 7	Reserved	Reserved				

Table 3-8. Character coding for transmission of aircraft identification by data link
 (subset of IA-5 — see 3.1.2.9.1.2)

				b_6	0	0	1	1
				b_5	0	1	0	1
b_4	b_3	b_2	b_1					
0	0	0	0			P	SP	0
0	0	0	1		A	Q		1
0	0	1	0		B	R		2
0	0	1	1		C	S		3
0	1	0	0		D	T		4
0	1	0	1		E	U		5
0	1	1	0		F	V		6
0	1	1	1		G	W		7
1	0	0	0		H	X		8
1	0	0	1		I	Y		9
1	0	1	0		J	Z		
1	0	1	1		K			
1	1	0	0		L			
1	1	0	1		M			
1	1	1	0		N			
1	1	1	1		O			

Table 3-9. Timer characteristics

<i>Timer</i>				<i>Duration</i>	<i>Tolerance</i>	
<i>Name</i>	<i>Number</i>	<i>Reference</i>	<i>Symbol</i>	<i>s</i>	<i>s</i>	<i>Resettable</i>
Non-selective lock-out	1	3.1.2.6.9.2	T_D	18	±1	no
Temporary alert	1	3.1.2.6.10.1.1.2	T_C	18	±1	no
SPI	1	3.1.2.6.10.1.3	T_I	18	±1	no
Reservations B, C, D	3*	3.1.2.6.11.3.1	T_R	18	±1	yes
Multisite lockout	78	3.1.2.6.9.1	T_L	18	±1	no

* As required

Table 3-10. DAPs registers

<i>Register</i>	<i>Name</i>	<i>Data content</i>	<i>Bits</i>
40 {HEX}	Selected vertical intention	MCP/FCU selected altitude	1-13
		FMS selected altitude	14-26
		Barometric pressure setting minus 800 mb	27-39
		MCP/FCU mode bits	48-51
		Target altitude source bits	54-56
50 {HEX}	Track and turn report	Roll angle	1-11
		True track angle	12-23
		Ground speed	24-34
		Track angle rate	35-45
		True airspeed	46-56
60 {HEX}	Heading and speed report	Magnetic heading	1-12
		Indicated airspeed	13-23
		Mach	24-34
		Barometric altitude rate	35-45
		Inertial vertical velocity	46-56

Table 3-11. Transmitted signal tolerances

<i>Reference</i>	<i>Function</i>	<i>Tolerance</i>
3.1.2.1.4.1	Pulse duration P_1, P_2, P_3, P_4, P_5 Pulse duration P_6	± 0.09 microsecond ± 0.20 microsecond
3.1.1.4	Pulse duration $P_1 - P_3$ Pulse duration $P_1 - P_2$	± 0.18 microsecond ± 0.10 microsecond
3.1.2.1.5.1.3	Pulse duration $P_3 - P_4$	± 0.04 microsecond
3.1.2.1.5.2.4	Pulse duration $P_1 - P_2$ Pulse duration P_2 — sync phase reversal Pulse duration P_6 — sync phase reversal Pulse duration P_5 — sync phase reversal	± 0.04 microsecond ± 0.04 microsecond ± 0.04 microsecond ± 0.05 microsecond
3.1.1.5	Pulse amplitude P_3	$P_1 \pm 0.5$ dB
3.1.2.1.5.1.4	Pulse amplitude P_4	$P_3 \pm 0.5$ dB
3.1.2.1.5.2.5	Pulse amplitude P_6	Equal to or greater than $P_2 - 0.25$ dB
3.1.2.1.4.1	Pulse rise times	0.05 microsecond minimum, 0.1 microsecond maximum
3.1.2.1.4.1	Pulse decay times	0.05 microsecond minimum, 0.2 microsecond maximum

FIGURES FOR CHAPTER 3

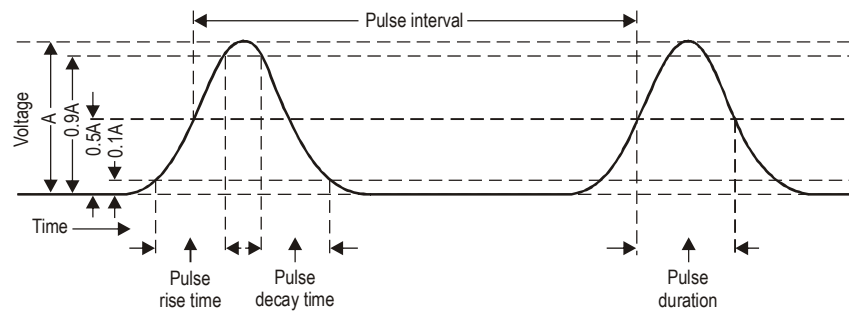

Definitions

Phase reversal. A 180-degree change in the phase of the radio frequency carrier.

Phase reversal duration. The time between the 10-degree and 170-degree points of a phase reversal.

Pulse amplitude A. The peak voltage amplitude of the pulse envelope.

Pulse decay time. The time between 0.9A and 0.1A on the trailing edge of the pulse envelope.

Pulse duration. The time interval between 0.5A points on leading and trailing edges of the pulse envelope.

Pulse interval. The time interval between the 0.5A point on the leading edge of the first pulse and the 0.5A point on the leading edge of the second pulse.

Pulse rise time. The time between 0.1A and 0.9A on the leading edge of the pulse envelope.

Time intervals. The intervals are referenced to:

- a) the 0.5A point on the leading edge of a pulse;
- b) the 0.5A point on the trailing edge of a pulse; or
- c) the 90-degree point of a phase reversal.

Transponder sensitivity and power reference point. The antenna end of the transmission line of the transponder.

Figure 3-1. Definitions of secondary surveillance radar waveform shapes, intervals and the reference point for sensitivity and power

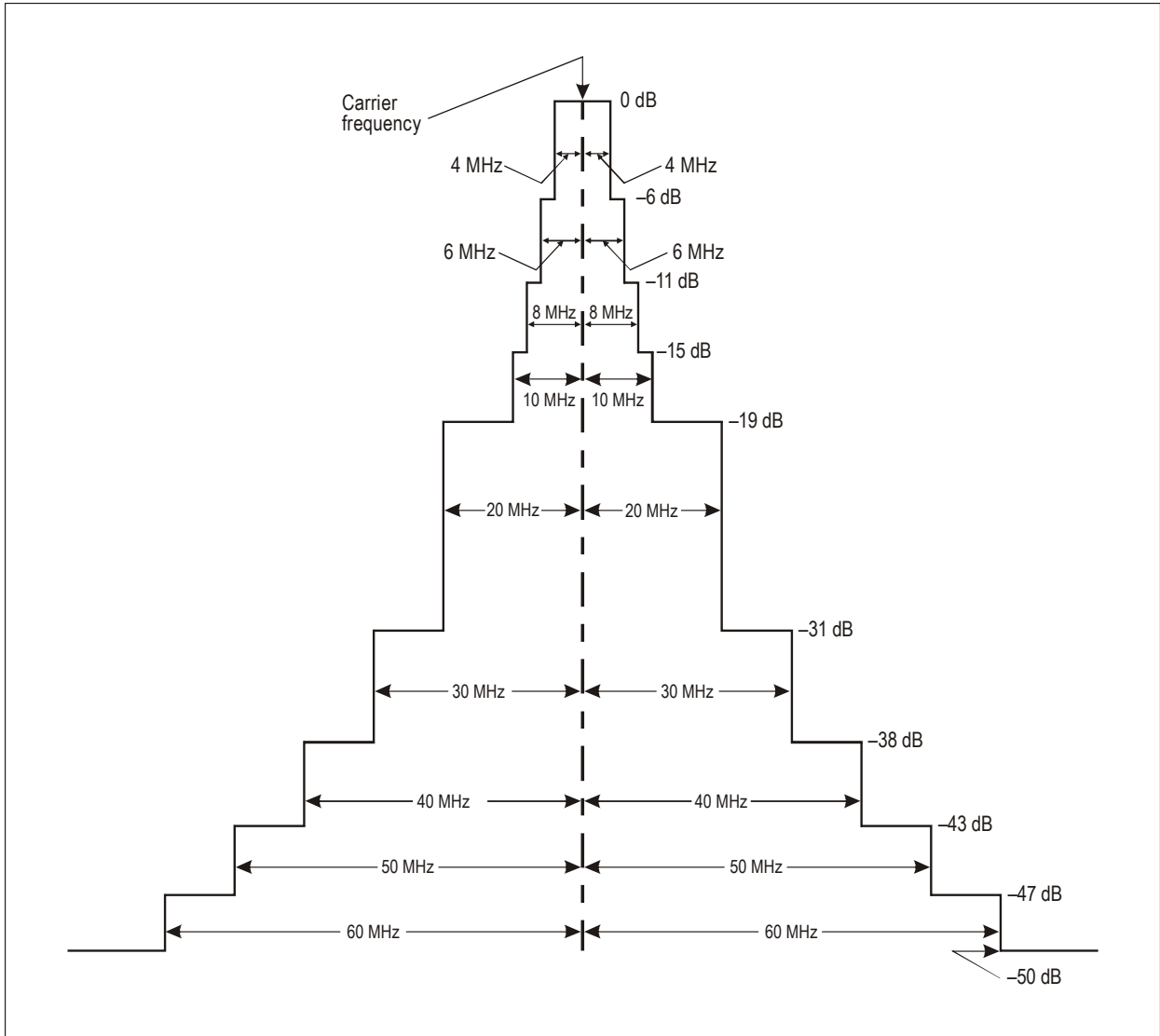

Figure 3-2. Required spectrum limits for interrogator transmitter

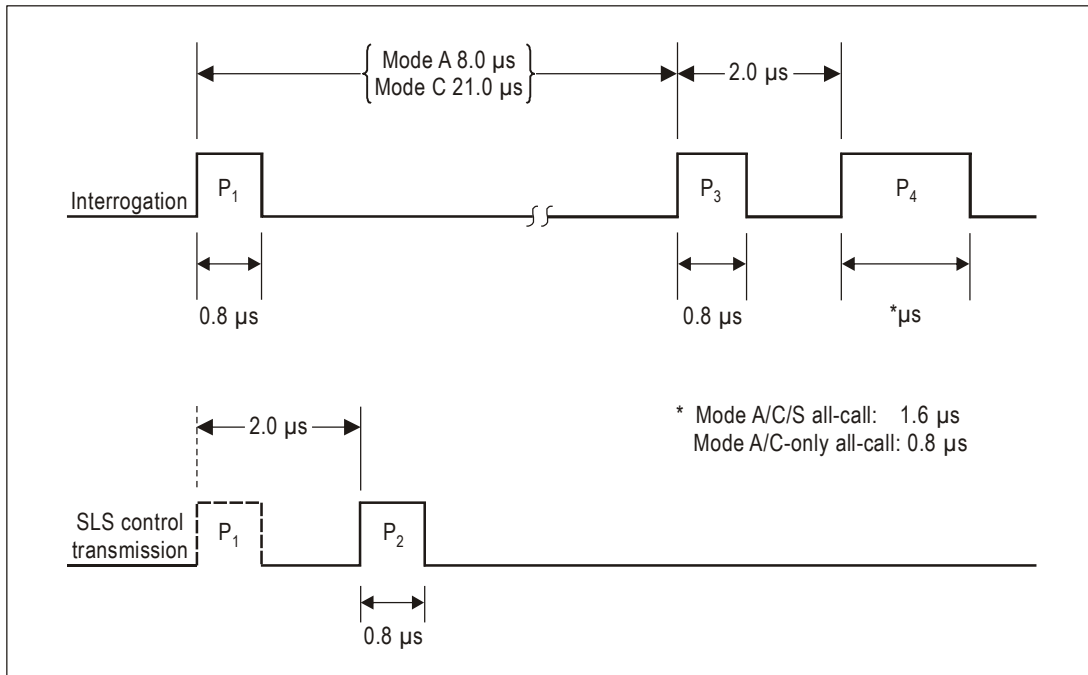

Figure 3-3. Intermode interrogation pulse sequence

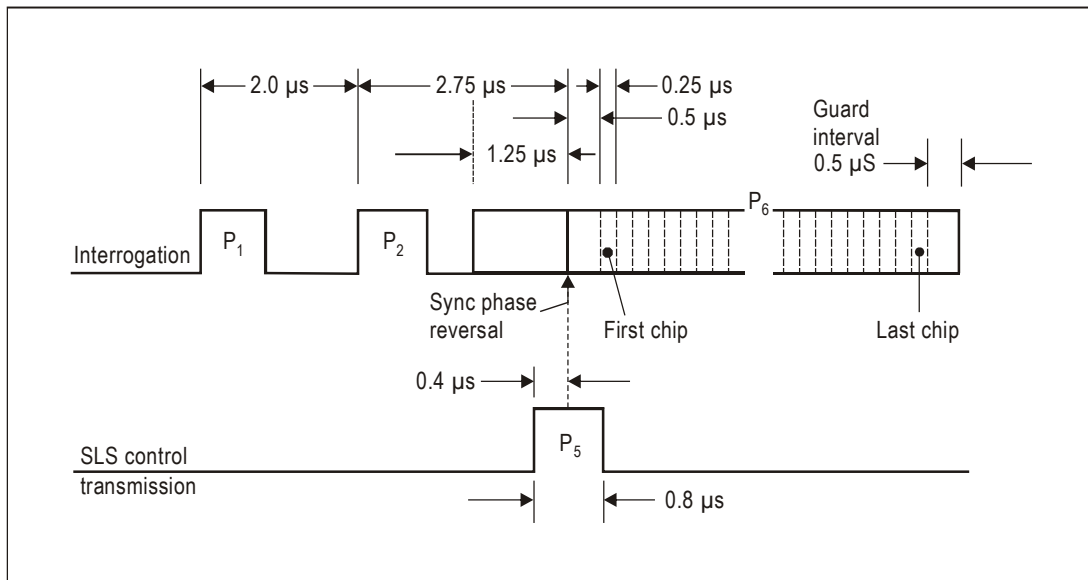

Figure 3-4. Mode S interrogation pulse sequence

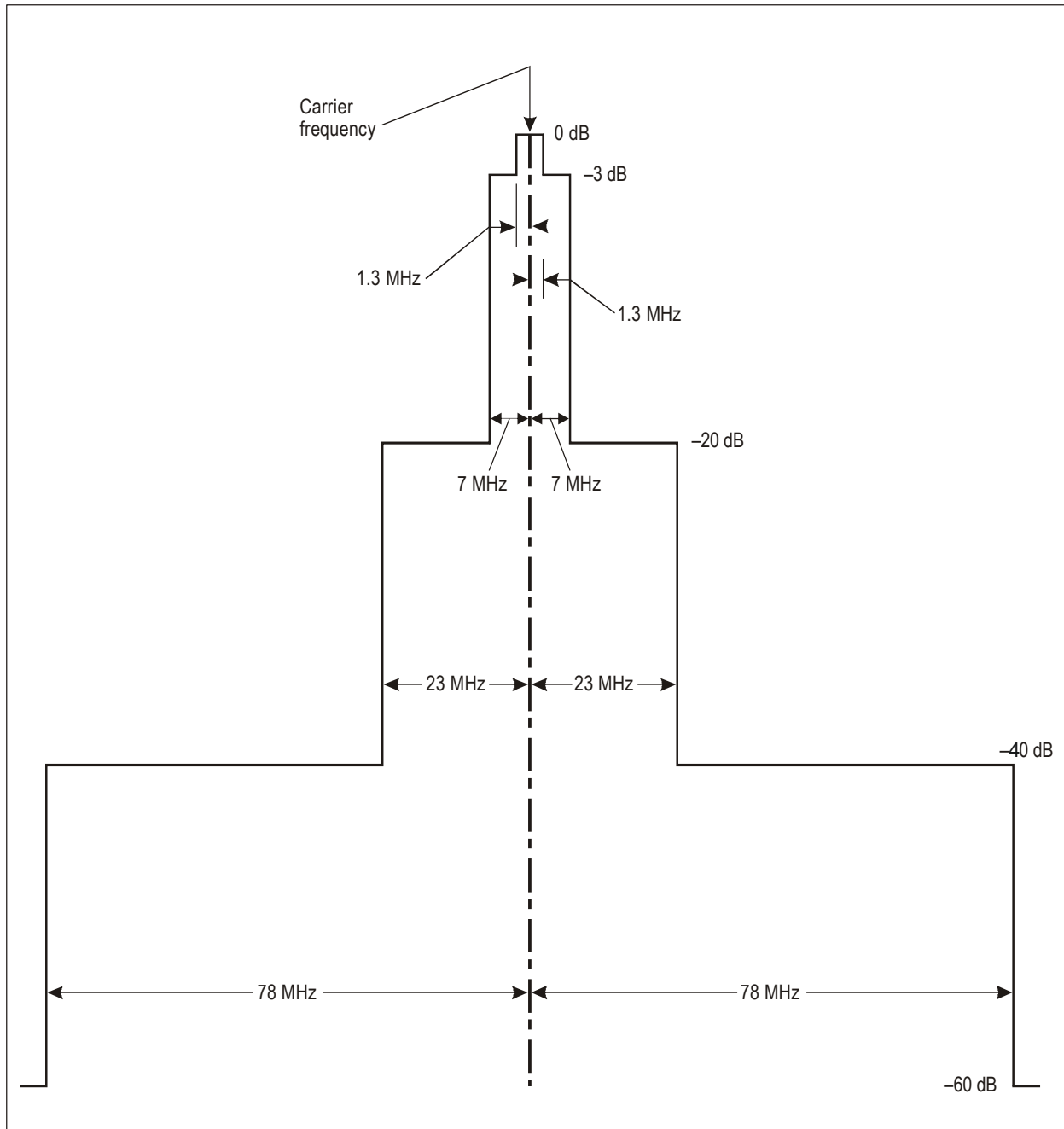

Figure 3-5. Required spectrum limits for transponder transmitter

Note.— This figure shows the spectrum centred on the carrier frequency and will therefore shift in its entirety plus or minus 1 MHz along with the carrier frequency.

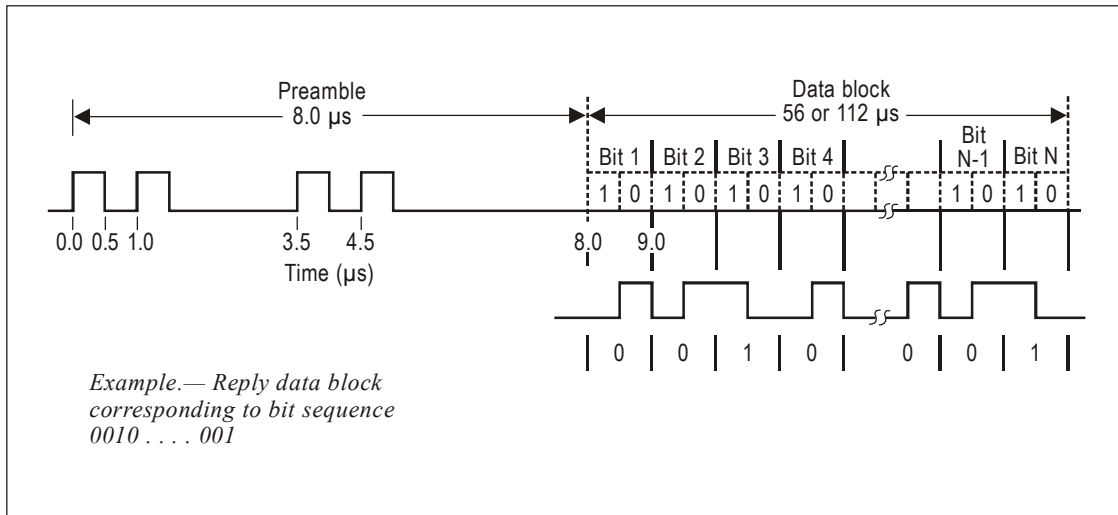

Figure 3-6. Mode S reply

Format No.	UF								
0	00000	3	RL:1	4	AQ:1	DS:8	10	AP:24	... Short air-air surveillance (ACAS)
1	00001	27 or 83					AP:24	...	Reserved
2	00010	27 or 83					AP:24	...	Reserved
3	00011	27 or 83					AP:24	...	Reserved
4	00100	PC:3	RR:5	DI:3	SD:16	AP:24	...	Surveillance, altitude request	
5	00101	PC:3	RR:5	DI:3	SD:16	AP:24	...	Surveillance, identify request	
6	00110	27 or 83					AP:24	...	Reserved
7	00111	27 or 83					AP:24	...	Reserved
8	01000	27 or 83					AP:24	...	Reserved
9	01001	27 or 83					AP:24	...	Reserved
10	01010	27 or 83					AP:24	...	Reserved
11	01011	PR:4	IC:4	CL:3	16	AP:24	...	Mode S only all-call	
12	01100	27 or 83					AP:24	...	Reserved
13	01101	27 or 83					AP:24	...	Reserved
14	01110	27 or 83					AP:24	...	Reserved
15	01111	27 or 83					AP:24	...	Reserved
16	10000	3	RL:1	4	AQ:1	18	MU:56	AP:24	... Long air-air surveillance (ACAS)
17	10001	27 or 83					AP:24	...	Reserved
18	10010	27 or 83					AP:24	...	Reserved
19	10011	27 or 83					AP:24	...	Reserved for military use
20	10100	PC:3	RR:5	DI:3	SD:16	MA:56	AP:24	...	Comm-A, altitude request
21	10101	PC:3	RR:5	DI:3	SD:16	MA:56	AP:24	...	Comm-A, identify request
22	10110	27 or 83					AP:24	...	Reserved for military use
23	10111	27 or 83					AP:24	...	Reserved
24	11	RC:2	NC:4	MC:80	AP:24	...	Comm-C (ELM)		

NOTES:

1.

XX:M

 denotes a field designated "XX" which is assigned M bits.
2.

N

 denotes unassigned coding space with N available bits. These shall be coded as ZEROs for transmission.
3. For uplink formats (UF) 0 to 23 the format number corresponds to the binary code in the first five bits of the interrogation. Format number 24 is defined as the format beginning with "11" in the first two bit positions while the following three bits vary with the interrogation content.
4. All formats are shown for completeness, although a number of them are unused. Those formats for which no application is presently defined remain undefined in length. Depending on future assignment they may be short (56 bits) or long (112 bits) formats. Specific formats associated with Mode S capability levels are described in later paragraphs.
5. The PC, RR, DI and SD fields do not apply to a Comm-A broadcast interrogation.

Figure 3-7. Summary of Mode S interrogation or uplink formats

Format No.	DF											
0	00000	VS:1	CC:1	1	SL:3	2	RI:4	2	AC:13	AP:24	... Short air-air surveillance (ACAS)	
1	00001	27 or 83									P:24	... Reserved
2	00010	27 or 83									P:24	... Reserved
3	00011	27 or 83									P:24	... Reserved
4	00100	FS:3		DR:5		UM:6		AC:13		AP:24	... Surveillance, altitude reply	
5	00101	FS:3		DR:5		UM:6		ID:13		AP:24	... Surveillance, identify reply	
6	00110	27 or 83									P:24	... Reserved
7	00111	27 or 83									P:24	... Reserved
8	01000	27 or 83									P:24	... Reserved
9	01001	27 or 83									P:24	... Reserved
10	01010	27 or 83									P:24	... Reserved
11	01011	CA:3			AA:24				PI:24		... All-call reply	
12	01100	27 or 83									P:24	... Reserved
13	01101	27 or 83									P:24	... Reserved
14	01110	27 or 83									P:24	... Reserved
15	01111	27 or 83									P:24	... Reserved
16	10000	VS:1	2	SL:3	2	RI:4	2	AC:13	MV:56	AP:24	... Long air-air surveillance (ACAS)	
17	10001	CA:3	AA:24			ME:56			PI:24		... Extended squitter	
18	10010	CF:3	AA:24		ME:56				PI:24		... Extended squitter/non transponder	
19	10011	AF:3	104									... Military extended squitter
20	10100	FS:3		DR:5		UM:6		AC:13	MB:56	AP:24 DP:24	... Comm-B, altitude reply ... (see Note 5)	
21	10101	FS:3		DR:5		UM:6		ID:13	MB:56	AP:24 DP:24	... Comm-B, identify reply ... (see Note 5)	
22	10110	27 or 83									P:24	... Reserved for military use
23	10111	27 or 83									P:24	... Reserved
24	11	1		KE:1		ND:4		MD:80	AP:24		... Comm-D (ELM)	

NOTES:

- | |
|------|
| XX:M |
|------|

 denotes a field designated "XX" which is assigned M bits.
- | |
|------|
| P:24 |
|------|

 denotes a 24-bit field reserved for parity information.
- | |
|---|
| N |
|---|

 denotes unassigned coding space with N available bits. These shall be coded as ZEROs for transmission.
- For downlink formats (DF) 0 to 23 the format number corresponds to the binary code in the first five bits of the reply. Format number 24 is defined as the format beginning with "11" in the first two bit positions while the following three bits may vary with the reply content.

- 4. All formats are shown for completeness, although a number of them are unused. Those formats for which no application is presently defined remain undefined in length. Depending on future assignment they may be short (56 bits) or long (112 bits) formats. Specific formats associated with Mode S capability levels are described in later paragraphs.
- 5. The Data parity (DP) (3.1.2.3.2.1.5) is used if it has been commanded by the OVC (3.1.2.6.1.4.1.i) in accordance with paragraph 3.1.2.6.11.2.5.

Figure 3-8. Summary of Mode S reply or downlink formats



APPENDIX TO CHAPTER 3

SSR AUTOMATIC PRESSURE-ALTITUDE TRANSMISSION CODE
(PULSE POSITION ASSIGNMENT)

RANGE	PULSE POSITIONS <i>(0 or 1 in a pulse position denotes absence or presence of a pulse, respectively)</i>													
	Increments <i>(Feet)</i>			D ₂	D ₄	A ₁	A ₂	A ₄	B ₁	B ₂	B ₄	C ₁	C ₂	C ₄
-1 000 to -950	0	0	0	0	0	0	0	0	0	0	0	0	1	0
-950 to -850	0	0	0	0	0	0	0	0	0	0	0	1	1	0
-850 to -750	0	0	0	0	0	0	0	0	0	0	0	1	0	0
-750 to -650	0	0	0	0	0	0	0	0	0	0	1	1	0	0
-650 to -550	0	0	0	0	0	0	0	0	0	0	1	1	1	0
-550 to -450	0	0	0	0	0	0	0	0	0	0	1	0	1	0
-450 to -350	0	0	0	0	0	0	0	0	0	0	1	0	1	1
-350 to -250	0	0	0	0	0	0	0	0	0	0	1	0	0	1
-250 to -150	0	0	0	0	0	0	0	0	0	1	1	0	0	1
-150 to -50	0	0	0	0	0	0	0	0	0	1	1	0	1	1
-50 to 50	0	0	0	0	0	0	0	0	0	1	1	0	1	0
50 to 150	0	0	0	0	0	0	0	0	0	1	1	1	1	0
150 to 250	0	0	0	0	0	0	0	0	0	1	1	1	0	0
250 to 350	0	0	0	0	0	0	0	0	0	1	0	1	0	0
350 to 450	0	0	0	0	0	0	0	0	0	1	0	1	1	0
450 to 550	0	0	0	0	0	0	0	0	0	1	0	0	1	0
550 to 650	0	0	0	0	0	0	0	0	0	1	0	0	1	1
650 to 750	0	0	0	0	0	0	0	0	0	1	0	0	0	1
750 to 850	0	0	0	0	0	0	0	0	1	1	0	0	0	1
850 to 950	0	0	0	0	0	0	0	0	1	1	0	0	1	1
950 to 1 050	0	0	0	0	0	0	0	0	1	1	0	0	1	0
1 050 to 1 150	0	0	0	0	0	0	0	0	1	1	0	1	1	0
1 150 to 1 250	0	0	0	0	0	0	0	0	1	1	0	1	0	0
1 250 to 1 350	0	0	0	0	0	0	0	0	1	1	1	1	0	0
1 350 to 1 450	0	0	0	0	0	0	0	0	1	1	1	1	1	0
1 450 to 1 550	0	0	0	0	0	0	0	0	1	1	1	0	1	0
1 550 to 1 650	0	0	0	0	0	0	0	0	1	1	1	0	1	1
1 650 to 1 750	0	0	0	0	0	0	0	0	1	1	1	0	0	1
1 750 to 1 850	0	0	0	0	0	0	0	0	1	0	1	0	0	1
1 850 to 1 950	0	0	0	0	0	0	0	0	1	0	1	0	1	1
1 950 to 2 050	0	0	0	0	0	0	0	0	1	0	1	0	1	0
2 050 to 2 150	0	0	0	0	0	0	0	0	1	0	1	1	1	0
2 150 to 2 250	0	0	0	0	0	0	0	0	1	0	1	1	0	0
2 250 to 2 350	0	0	0	0	0	0	0	0	1	0	0	1	0	0
2 350 to 2 450	0	0	0	0	0	0	0	0	1	0	0	1	1	0
2 450 to 2 550	0	0	0	0	0	0	0	0	1	0	0	0	1	0
2 550 to 2 650	0	0	0	0	0	0	0	0	1	0	0	0	1	1
2 650 to 2 750	0	0	0	0	0	0	0	0	1	0	0	0	0	1

RANGE	PULSE POSITIONS (0 or 1 in a pulse position denotes absence or presence of a pulse, respectively)												
	Increments (Feet)		D ₂	D ₄	A ₁	A ₂	A ₄	B ₁	B ₂	B ₄	C ₁	C ₂	C ₄
2 750	to	2 850	0	0	0	0	1	1	0	0	0	0	1
2 850	to	2 950	0	0	0	0	1	1	0	0	0	1	1
2 950	to	3 050	0	0	0	0	1	1	0	0	0	1	0
3 050	to	3 150	0	0	0	0	1	1	0	0	1	1	0
3 150	to	3 250	0	0	0	0	1	1	0	0	1	0	0
3 250	to	3 350	0	0	0	0	1	1	0	1	1	0	0
3 350	to	3 450	0	0	0	0	1	1	0	1	1	1	0
3 450	to	3 550	0	0	0	0	1	1	0	1	0	1	0
3 550	to	3 650	0	0	0	0	1	1	0	1	0	1	1
3 650	to	3 750	0	0	0	0	1	1	0	1	0	0	1
3 750	to	3 850	0	0	0	0	1	1	1	1	0	0	1
3 850	to	3 950	0	0	0	0	1	1	1	1	0	1	1
3 950	to	4 050	0	0	0	0	1	1	1	1	0	1	0
4 050	to	4 150	0	0	0	0	1	1	1	1	1	1	0
4 150	to	4 250	0	0	0	0	1	1	1	1	1	0	0
4 250	to	4 350	0	0	0	0	1	1	1	0	1	0	0
4 350	to	4 450	0	0	0	0	1	1	1	0	1	1	0
4 450	to	4 550	0	0	0	0	1	1	1	0	0	1	0
4 550	to	4 650	0	0	0	0	1	1	1	0	0	1	1
4 650	to	4 750	0	0	0	0	1	1	1	0	0	0	1
4 750	to	4 850	0	0	0	0	1	0	1	0	0	0	1
4 850	to	4 950	0	0	0	0	1	0	1	0	0	1	1
4 950	to	5 050	0	0	0	0	1	0	1	0	0	1	0
5 050	to	5 150	0	0	0	0	1	0	1	0	1	1	0
5 150	to	5 250	0	0	0	0	1	0	1	0	1	0	0
5 250	to	5 350	0	0	0	0	1	0	1	1	1	0	0
5 350	to	5 450	0	0	0	0	1	0	1	1	1	1	0
5 450	to	5 550	0	0	0	0	1	0	1	1	0	1	0
5 550	to	5 650	0	0	0	0	1	0	1	1	0	1	1
5 650	to	5 750	0	0	0	0	1	0	1	1	0	0	1
5 750	to	5 850	0	0	0	0	1	0	0	1	0	0	1
5 850	to	5 950	0	0	0	0	1	0	0	1	0	1	1
5 950	to	6 050	0	0	0	0	1	0	0	1	0	1	0
6 050	to	6 150	0	0	0	0	1	0	0	1	1	1	0
6 150	to	6 250	0	0	0	0	1	0	0	1	1	0	0
6 250	to	6 350	0	0	0	0	1	0	0	0	1	0	0
6 350	to	6 450	0	0	0	0	1	0	0	0	1	1	0
6 450	to	6 550	0	0	0	0	1	0	0	0	0	1	0
6 550	to	6 650	0	0	0	0	1	0	0	0	0	1	1
6 650	to	6 750	0	0	0	0	1	0	0	0	0	0	1
6 750	to	6 850	0	0	0	1	1	0	0	0	0	0	1
6 850	to	6 950	0	0	0	1	1	0	0	0	0	1	1
6 950	to	7 050	0	0	0	1	1	0	0	0	0	1	0
7 050	to	7 150	0	0	0	1	1	0	0	0	1	1	0
7 150	to	7 250	0	0	0	1	1	0	0	0	1	0	0

RANGE	PULSE POSITIONS (0 or 1 in a pulse position denotes absence or presence of a pulse, respectively)													
	Increments (Feet)			D ₂	D ₄	A ₁	A ₂	A ₄	B ₁	B ₂	B ₄	C ₁	C ₂	C ₄
7 250 to 7 350	0	0	0	1	1	0	0	1	1	0	0	1	0	0
7 350 to 7 450	0	0	0	1	1	0	0	1	1	0	0	1	1	0
7 450 to 7 550	0	0	0	1	1	0	0	1	1	0	0	1	1	0
7 550 to 7 650	0	0	0	1	1	0	0	1	1	0	0	1	1	1
7 650 to 7 750	0	0	0	1	1	0	0	1	1	0	0	1	0	1
7 750 to 7 850	0	0	0	1	1	0	1	1	1	0	1	1	0	1
7 850 to 7 950	0	0	0	1	1	0	1	1	1	0	1	1	1	1
7 950 to 8 050	0	0	0	1	1	0	1	1	1	0	1	1	0	0
8 050 to 8 150	0	0	0	1	1	0	1	1	1	0	1	1	1	0
8 150 to 8 250	0	0	0	1	1	0	1	1	1	0	1	1	0	0
8 250 to 8 350	0	0	0	1	1	0	1	0	1	0	1	0	0	0
8 350 to 8 450	0	0	0	1	1	0	1	0	1	0	1	1	1	0
8 450 to 8 550	0	0	0	1	1	0	1	0	1	0	0	1	0	0
8 550 to 8 650	0	0	0	1	1	0	1	0	1	0	0	1	1	1
8 650 to 8 750	0	0	0	1	1	0	1	0	1	0	0	0	0	1
8 750 to 8 850	0	0	0	1	1	1	1	1	1	0	0	0	0	1
8 850 to 8 950	0	0	0	1	1	1	1	1	1	0	0	1	1	1
8 950 to 9 050	0	0	0	1	1	1	1	1	1	0	0	1	0	0
9 050 to 9 150	0	0	0	1	1	1	1	1	1	0	1	1	1	0
9 150 to 9 250	0	0	0	1	1	1	1	1	1	0	1	0	0	0
9 250 to 9 350	0	0	0	1	1	1	1	1	1	1	1	0	0	0
9 350 to 9 450	0	0	0	1	1	1	1	1	1	1	1	1	1	0
9 450 to 9 550	0	0	0	1	1	1	1	1	1	1	0	1	0	0
9 550 to 9 650	0	0	0	1	1	1	1	1	1	1	0	1	1	1
9 650 to 9 750	0	0	0	1	1	1	1	1	1	1	0	0	0	1
9 750 to 9 850	0	0	0	1	1	1	0	1	0	1	0	0	0	1
9 850 to 9 950	0	0	0	1	1	1	0	1	0	1	0	1	1	1
9 950 to 10 050	0	0	0	1	1	1	0	1	0	1	0	1	0	0
10 050 to 10 150	0	0	0	1	1	1	0	1	0	1	1	1	1	0
10 150 to 10 250	0	0	0	1	1	1	0	1	0	1	1	0	0	0
10 250 to 10 350	0	0	0	1	1	1	0	0	0	0	1	0	0	0
10 350 to 10 450	0	0	0	1	1	1	0	0	0	0	1	1	1	0
10 450 to 10 550	0	0	0	1	1	1	0	0	0	0	0	1	0	0
10 550 to 10 650	0	0	0	1	1	1	0	0	0	0	0	1	1	1
10 650 to 10 750	0	0	0	1	1	1	0	0	0	0	0	0	0	1
10 750 to 10 850	0	0	0	1	0	1	0	0	0	0	0	0	0	1
10 850 to 10 950	0	0	0	1	0	1	0	0	0	0	0	1	1	1
10 950 to 11 050	0	0	0	1	0	1	0	0	0	0	0	1	0	0
11 050 to 11 150	0	0	0	1	0	1	0	0	0	0	1	1	1	0
11 150 to 11 250	0	0	0	1	0	1	0	0	0	0	1	0	0	0
11 250 to 11 350	0	0	0	1	0	1	0	1	0	1	1	0	0	0
11 350 to 11 450	0	0	0	1	0	1	0	1	0	1	1	1	1	0
11 450 to 11 550	0	0	0	1	0	1	0	1	0	1	0	1	0	0
11 550 to 11 650	0	0	0	1	0	1	0	1	0	1	0	1	1	1
11 650 to 11 750	0	0	0	1	0	1	0	1	0	1	0	0	0	1

RANGE	PULSE POSITIONS (0 or 1 in a pulse position denotes absence or presence of a pulse, respectively)												
	Increments (Feet)			D ₂	D ₄	A ₁	A ₂	A ₄	B ₁	B ₂	B ₄	C ₁	C ₂
11 750 to 11 850	0	0	0	1	0	1	1	1	0	0	0	1	
11 850 to 11 950	0	0	0	1	0	1	1	1	0	1	1	1	
11 950 to 12 050	0	0	0	1	0	1	1	1	0	1	1	0	
12 050 to 12 150	0	0	0	1	0	1	1	1	1	1	1	0	
12 150 to 12 250	0	0	0	1	0	1	1	1	1	1	0	0	
12 250 to 12 350	0	0	0	1	0	1	1	0	1	0	1	0	
12 350 to 12 450	0	0	0	1	0	1	1	0	1	1	1	0	
12 450 to 12 550	0	0	0	1	0	1	1	0	1	0	0	1	
12 550 to 12 650	0	0	0	1	0	1	1	0	1	1	0	1	
12 650 to 12 750	0	0	0	1	0	1	1	0	1	1	0	1	
12 750 to 12 850	0	0	0	1	0	0	1	0	0	1	0	1	
12 850 to 12 950	0	0	0	1	0	0	1	0	0	1	0	1	
12 950 to 13 050	0	0	0	1	0	0	1	0	0	1	0	0	
13 050 to 13 150	0	0	0	1	0	0	1	0	0	1	1	0	
13 150 to 13 250	0	0	0	1	0	0	1	0	0	1	0	0	
13 250 to 13 350	0	0	0	1	0	0	1	1	0	1	0	0	
13 350 to 13 450	0	0	0	1	0	0	1	1	0	1	1	0	
13 450 to 13 550	0	0	0	1	0	0	1	1	0	1	0	0	
13 550 to 13 650	0	0	0	1	0	0	1	1	0	1	1	1	
13 650 to 13 750	0	0	0	1	0	0	1	1	0	1	0	1	
13 750 to 13 850	0	0	0	1	0	0	0	1	0	0	0	1	
13 850 to 13 950	0	0	0	1	0	0	0	1	0	0	1	1	
13 950 to 14 050	0	0	0	1	0	0	0	1	0	0	1	0	
14 050 to 14 150	0	0	0	1	0	0	0	1	0	0	1	0	
14 150 to 14 250	0	0	0	1	0	0	0	1	0	0	1	0	
14 250 to 14 350	0	0	0	1	0	0	0	0	1	0	0	0	
14 350 to 14 450	0	0	0	1	0	0	0	0	1	1	1	0	
14 450 to 14 550	0	0	0	1	0	0	0	0	0	1	0	0	
14 550 to 14 650	0	0	0	1	0	0	0	0	0	1	1	1	
14 650 to 14 750	0	0	0	1	0	0	0	0	0	0	0	1	
14 750 to 14 850	0	0	1	1	0	0	0	0	0	0	0	1	
14 850 to 14 950	0	0	1	1	0	0	0	0	0	0	1	1	
14 950 to 15 050	0	0	1	1	0	0	0	0	0	0	1	0	
15 050 to 15 150	0	0	1	1	0	0	0	0	0	1	1	0	
15 150 to 15 250	0	0	1	1	0	0	0	0	0	1	0	0	
15 250 to 15 350	0	0	1	1	0	0	0	1	1	0	0	0	
15 350 to 15 450	0	0	1	1	0	0	0	1	1	1	1	0	
15 450 to 15 550	0	0	1	1	0	0	0	1	0	1	0	0	
15 550 to 15 650	0	0	1	1	0	0	0	1	0	1	1	1	
15 650 to 15 750	0	0	1	1	0	0	0	1	0	0	0	1	
15 750 to 15 850	0	0	1	1	0	0	1	1	0	0	0	1	
15 850 to 15 950	0	0	1	1	0	0	1	1	0	1	1	1	
15 950 to 16 050	0	0	1	1	0	0	1	1	0	1	0	0	
16 050 to 16 150	0	0	1	1	0	0	1	1	1	1	1	0	
16 150 to 16 250	0	0	1	1	0	0	1	1	1	0	0	0	

RANGE	PULSE POSITIONS (0 or 1 in a pulse position denotes absence or presence of a pulse, respectively)												
	Increments (Feet)			D ₂	D ₄	A ₁	A ₂	A ₄	B ₁	B ₂	B ₄	C ₁	C ₂
16 250 to 16 350	0	0	1	1	0	0	1	0	1	0	1	0	0
16 350 to 16 450	0	0	1	1	0	0	1	0	1	0	1	1	0
16 450 to 16 550	0	0	1	1	0	0	1	0	1	0	0	1	0
16 550 to 16 650	0	0	1	1	0	0	1	0	1	0	0	1	1
16 650 to 16 750	0	0	1	1	0	0	1	0	1	0	0	0	1
16 750 to 16 850	0	0	1	1	0	1	1	1	0	0	0	0	1
16 850 to 16 950	0	0	1	1	0	1	1	1	0	0	0	1	1
16 950 to 17 050	0	0	1	1	0	1	1	1	0	0	0	1	0
17 050 to 17 150	0	0	1	1	0	1	1	1	0	1	1	1	0
17 150 to 17 250	0	0	1	1	0	1	1	1	0	1	1	0	0
17 250 to 17 350	0	0	1	1	0	1	1	1	1	1	1	0	0
17 350 to 17 450	0	0	1	1	0	1	1	1	1	1	1	1	0
17 450 to 17 550	0	0	1	1	0	1	1	1	1	1	0	1	0
17 550 to 17 650	0	0	1	1	0	1	1	1	1	1	0	1	1
17 650 to 17 750	0	0	1	1	0	1	1	1	1	1	0	0	1
17 750 to 17 850	0	0	1	1	0	1	0	1	0	1	0	0	1
17 850 to 17 950	0	0	1	1	0	1	0	1	0	1	0	1	1
17 950 to 18 050	0	0	1	1	0	1	0	1	0	1	0	1	0
18 050 to 18 150	0	0	1	1	0	1	0	1	0	1	1	1	0
18 150 to 18 250	0	0	1	1	0	1	0	1	0	1	1	0	0
18 250 to 18 350	0	0	1	1	0	1	0	0	0	1	0	0	0
18 350 to 18 450	0	0	1	1	0	1	0	0	0	1	1	1	0
18 450 to 18 550	0	0	1	1	0	1	0	0	0	0	0	1	0
18 550 to 18 650	0	0	1	1	0	1	0	0	0	0	0	1	1
18 650 to 18 750	0	0	1	1	0	1	0	0	0	0	0	0	1
18 750 to 18 850	0	0	1	1	1	1	0	0	0	0	0	0	1
18 850 to 18 950	0	0	1	1	1	1	0	0	0	0	0	1	1
18 950 to 19 050	0	0	1	1	1	1	0	0	0	0	0	1	0
19 050 to 19 150	0	0	1	1	1	1	0	0	0	1	1	1	0
19 150 to 19 250	0	0	1	1	1	1	0	0	0	1	0	0	0
19 250 to 19 350	0	0	1	1	1	1	0	1	1	1	0	0	0
19 350 to 19 450	0	0	1	1	1	1	0	1	0	1	1	1	0
19 450 to 19 550	0	0	1	1	1	1	0	1	0	1	0	1	0
19 550 to 19 650	0	0	1	1	1	1	0	1	0	1	0	1	1
19 650 to 19 750	0	0	1	1	1	1	0	1	0	1	0	0	1
19 750 to 19 850	0	0	1	1	1	1	1	1	1	0	0	0	1
19 850 to 19 950	0	0	1	1	1	1	1	1	1	0	0	1	1
19 950 to 20 050	0	0	1	1	1	1	1	1	1	0	0	1	0
20 050 to 20 150	0	0	1	1	1	1	1	1	1	1	1	1	0
20 150 to 20 250	0	0	1	1	1	1	1	1	1	1	1	0	0
20 250 to 20 350	0	0	1	1	1	1	1	0	0	1	0	0	0
20 350 to 20 450	0	0	1	1	1	1	1	0	0	1	1	1	0
20 450 to 20 550	0	0	1	1	1	1	1	0	0	0	0	1	0
20 550 to 20 650	0	0	1	1	1	1	1	0	0	0	0	1	1
20 650 to 20 750	0	0	1	1	1	1	1	0	0	0	0	0	1

RANGE	PULSE POSITIONS (0 or 1 in a pulse position denotes absence or presence of a pulse, respectively)												
	Increments (Feet)			D ₂	D ₄	A ₁	A ₂	A ₄	B ₁	B ₂	B ₄	C ₁	C ₂
20 750 to 20 850	0	0	1	1	1	0	1	0	0	0	0	0	1
20 850 to 20 950	0	0	1	1	1	0	1	0	0	0	0	1	1
20 950 to 21 050	0	0	1	1	1	0	1	0	0	0	0	1	0
21 050 to 21 150	0	0	1	1	1	0	1	0	0	0	1	1	0
21 150 to 21 250	0	0	1	1	1	0	1	0	0	0	1	0	0
21 250 to 21 350	0	0	1	1	1	0	1	1	1	1	1	0	0
21 350 to 21 450	0	0	1	1	1	0	1	1	1	1	1	1	0
21 450 to 21 550	0	0	1	1	1	0	1	1	1	1	0	1	0
21 550 to 21 650	0	0	1	1	1	0	1	1	1	1	0	1	1
21 650 to 21 750	0	0	1	1	1	0	1	1	1	1	0	0	1
21 750 to 21 850	0	0	1	1	1	0	0	0	0	1	0	0	1
21 850 to 21 950	0	0	1	1	1	0	0	0	0	1	0	1	1
21 950 to 22 050	0	0	1	1	1	0	0	0	0	1	0	1	0
22 050 to 22 150	0	0	1	1	1	0	0	0	0	1	1	1	0
22 150 to 22 250	0	0	1	1	1	0	0	0	0	1	1	0	0
22 250 to 22 350	0	0	1	1	1	0	0	0	0	0	1	0	0
22 350 to 22 450	0	0	1	1	1	0	0	0	0	0	1	1	0
22 450 to 22 550	0	0	1	1	1	0	0	0	0	0	0	1	0
22 550 to 22 650	0	0	1	1	1	0	0	0	0	0	0	1	1
22 650 to 22 750	0	0	1	1	1	0	0	0	0	0	0	0	1
22 750 to 22 850	0	0	1	0	1	0	0	0	0	0	0	0	1
22 850 to 22 950	0	0	1	0	1	0	0	0	0	0	0	1	1
22 950 to 23 050	0	0	1	0	1	0	0	0	0	0	0	1	0
23 050 to 23 150	0	0	1	0	1	0	0	0	0	0	1	1	0
23 150 to 23 250	0	0	1	0	1	0	0	0	0	0	1	0	0
23 250 to 23 350	0	0	1	0	1	0	0	0	0	1	1	0	0
23 350 to 23 450	0	0	1	0	1	0	0	0	0	1	1	1	0
23 450 to 23 550	0	0	1	0	1	0	0	0	0	1	0	1	0
23 550 to 23 650	0	0	1	0	1	0	0	0	0	1	0	1	1
23 650 to 23 750	0	0	1	0	1	0	0	0	0	1	0	0	1
23 750 to 23 850	0	0	1	0	1	0	1	1	1	1	0	0	1
23 850 to 23 950	0	0	1	0	1	0	1	1	1	1	0	1	1
23 950 to 24 050	0	0	1	0	1	0	1	1	1	1	0	1	0
24 050 to 24 150	0	0	1	0	1	0	1	1	1	1	1	1	0
24 150 to 24 250	0	0	1	0	1	0	1	1	1	1	1	0	0
24 250 to 24 350	0	0	1	0	1	0	1	0	0	0	1	0	0
24 350 to 24 450	0	0	1	0	1	0	1	0	0	0	1	1	0
24 450 to 24 550	0	0	1	0	1	0	1	0	0	0	0	1	0
24 550 to 24 650	0	0	1	0	1	0	1	0	0	0	0	1	1
24 650 to 24 750	0	0	1	0	1	0	1	0	0	0	0	0	1
24 750 to 24 850	0	0	1	0	1	1	1	1	0	0	0	0	1
24 850 to 24 950	0	0	1	0	1	1	1	1	0	0	0	1	1
24 950 to 25 050	0	0	1	0	1	1	1	1	0	0	0	1	0
25 050 to 25 150	0	0	1	0	1	1	1	1	0	1	1	1	0
25 150 to 25 250	0	0	1	0	1	1	1	1	0	1	0	0	0

RANGE	PULSE POSITIONS (0 or 1 in a pulse position denotes absence or presence of a pulse, respectively)												
	Increments (Feet)			D ₂	D ₄	A ₁	A ₂	A ₄	B ₁	B ₂	B ₄	C ₁	C ₂
25 250 to 25 350	0	0	1	0	1	1	1	1	1	1	1	0	0
25 350 to 25 450	0	0	1	0	1	1	1	1	1	1	1	1	0
25 450 to 25 550	0	0	1	0	1	1	1	1	1	1	0	1	0
25 550 to 25 650	0	0	1	0	1	1	1	1	1	1	0	1	1
25 650 to 25 750	0	0	1	0	1	1	1	1	1	1	0	0	1
25 750 to 25 850	0	0	1	0	1	1	0	1	0	1	0	0	1
25 850 to 25 950	0	0	1	0	1	1	0	1	0	1	0	1	1
25 950 to 26 050	0	0	1	0	1	1	0	1	0	1	0	1	0
26 050 to 26 150	0	0	1	0	1	1	0	1	0	1	1	1	0
26 150 to 26 250	0	0	1	0	1	1	0	1	0	1	1	0	0
26 250 to 26 350	0	0	1	0	1	1	0	0	0	0	1	0	0
26 350 to 26 450	0	0	1	0	1	1	0	0	0	0	1	1	0
26 450 to 26 550	0	0	1	0	1	1	0	0	0	0	0	1	0
26 550 to 26 650	0	0	1	0	1	1	0	0	0	0	0	1	1
26 650 to 26 750	0	0	1	0	1	1	0	0	0	0	0	0	1
26 750 to 26 850	0	0	1	0	0	1	0	0	0	0	0	0	1
26 850 to 26 950	0	0	1	0	0	1	0	0	0	0	0	1	1
26 950 to 27 050	0	0	1	0	0	1	0	0	0	0	0	1	0
27 050 to 27 150	0	0	1	0	0	1	0	0	0	0	1	1	0
27 150 to 27 250	0	0	1	0	0	1	0	0	0	0	1	0	0
27 250 to 27 350	0	0	1	0	0	1	0	1	0	1	1	0	0
27 350 to 27 450	0	0	1	0	0	1	0	1	0	1	1	1	0
27 450 to 27 550	0	0	1	0	0	1	0	1	0	1	0	1	0
27 550 to 27 650	0	0	1	0	0	1	0	1	0	1	0	1	1
27 650 to 27 750	0	0	1	0	0	1	0	1	0	1	0	0	1
27 750 to 27 850	0	0	1	0	0	1	1	1	1	1	0	0	1
27 850 to 27 950	0	0	1	0	0	1	1	1	1	1	0	1	1
27 950 to 28 050	0	0	1	0	0	1	1	1	1	1	0	1	0
28 050 to 28 150	0	0	1	0	0	1	1	1	1	1	1	1	0
28 150 to 28 250	0	0	1	0	0	1	1	1	1	1	1	0	0
28 250 to 28 350	0	0	1	0	0	1	1	0	0	0	1	0	0
28 350 to 28 450	0	0	1	0	0	1	1	0	0	0	1	1	0
28 450 to 28 550	0	0	1	0	0	1	1	0	0	0	0	1	0
28 550 to 28 650	0	0	1	0	0	1	1	0	0	0	0	1	1
28 650 to 28 750	0	0	1	0	0	1	1	0	0	0	0	0	1
28 750 to 28 850	0	0	1	0	0	0	1	0	0	0	0	0	1
28 850 to 28 950	0	0	1	0	0	0	1	0	0	0	0	1	1
28 950 to 29 050	0	0	1	0	0	0	1	0	0	0	0	1	0
29 050 to 29 150	0	0	1	0	0	0	1	0	0	0	1	1	0
29 150 to 29 250	0	0	1	0	0	0	1	0	0	0	1	0	0
29 250 to 29 350	0	0	1	0	0	0	1	1	1	1	1	0	0
29 350 to 29 450	0	0	1	0	0	0	1	1	1	1	1	1	0
29 450 to 29 550	0	0	1	0	0	0	1	1	1	1	0	1	0
29 550 to 29 650	0	0	1	0	0	0	1	1	1	1	0	1	1
29 650 to 29 750	0	0	1	0	0	0	1	1	1	1	0	0	1

RANGE	PULSE POSITIONS (0 or 1 in a pulse position denotes absence or presence of a pulse, respectively)												
	Increments (Feet)			D ₂	D ₄	A ₁	A ₂	A ₄	B ₁	B ₂	B ₄	C ₁	C ₂
29 750 to 29 850	0	0	1	0	0	0	0	0	1	0	0	1	
29 850 to 29 950	0	0	1	0	0	0	0	0	1	0	1	1	
29 950 to 30 050	0	0	1	0	0	0	0	0	1	0	1	0	
30 050 to 30 150	0	0	1	0	0	0	0	0	1	1	1	0	
30 150 to 30 250	0	0	1	0	0	0	0	0	1	1	0	0	
30 250 to 30 350	0	0	1	0	0	0	0	0	0	1	0	0	
30 350 to 30 450	0	0	1	0	0	0	0	0	0	1	1	0	
30 450 to 30 550	0	0	1	0	0	0	0	0	0	0	1	0	
30 550 to 30 650	0	0	1	0	0	0	0	0	0	0	1	1	
30 650 to 30 750	0	0	1	0	0	0	0	0	0	0	0	1	
30 750 to 30 850	0	1	1	0	0	0	0	0	0	0	0	1	
30 850 to 30 950	0	1	1	0	0	0	0	0	0	0	1	1	
30 950 to 31 050	0	1	1	0	0	0	0	0	0	0	1	0	
31 050 to 31 150	0	1	1	0	0	0	0	0	0	1	1	0	
31 150 to 31 250	0	1	1	0	0	0	0	0	0	1	0	0	
31 250 to 31 350	0	1	1	0	0	0	0	0	1	1	0	0	
31 350 to 31 450	0	1	1	0	0	0	0	0	1	1	1	0	
31 450 to 31 550	0	1	1	0	0	0	0	0	1	0	1	0	
31 550 to 31 650	0	1	1	0	0	0	0	0	1	0	1	1	
31 650 to 31 750	0	1	1	0	0	0	0	0	1	0	0	1	
31 750 to 31 850	0	1	1	0	0	0	1	1	1	0	0	1	
31 850 to 31 950	0	1	1	0	0	0	1	1	1	0	1	1	
31 950 to 32 050	0	1	1	0	0	0	1	1	1	0	1	0	
32 050 to 32 150	0	1	1	0	0	0	1	1	1	1	1	0	
32 150 to 32 250	0	1	1	0	0	0	1	1	1	1	0	0	
32 250 to 32 350	0	1	1	0	0	0	1	0	0	1	0	0	
32 350 to 32 450	0	1	1	0	0	0	1	0	0	1	1	0	
32 450 to 32 550	0	1	1	0	0	0	1	0	0	0	1	0	
32 550 to 32 650	0	1	1	0	0	0	1	0	0	0	1	1	
32 650 to 32 750	0	1	1	0	0	0	1	0	0	0	0	1	
32 750 to 32 850	0	1	1	0	0	1	1	0	0	0	0	1	
32 850 to 32 950	0	1	1	0	0	1	1	0	0	0	1	1	
32 950 to 33 050	0	1	1	0	0	1	1	0	0	0	1	0	
33 050 to 33 150	0	1	1	0	0	1	1	0	1	1	1	0	
33 150 to 33 250	0	1	1	0	0	1	1	0	1	1	0	0	
33 250 to 33 350	0	1	1	0	0	1	1	1	1	1	0	0	
33 350 to 33 450	0	1	1	0	0	1	1	1	1	1	1	0	
33 450 to 33 550	0	1	1	0	0	1	1	1	0	0	1	0	
33 550 to 33 650	0	1	1	0	0	1	1	1	0	0	1	1	
33 650 to 33 750	0	1	1	0	0	1	1	1	0	0	0	1	
33 750 to 33 850	0	1	1	0	0	1	0	1	0	0	0	1	
33 850 to 33 950	0	1	1	0	0	1	0	1	0	0	1	1	
33 950 to 34 050	0	1	1	0	0	1	0	1	0	0	1	0	
34 050 to 34 150	0	1	1	0	0	1	0	1	1	1	1	0	
34 150 to 34 250	0	1	1	0	0	1	0	1	1	1	0	0	

RANGE	PULSE POSITIONS (0 or 1 in a pulse position denotes absence or presence of a pulse, respectively)													
	Increments (Feet)			D ₂	D ₄	A ₁	A ₂	A ₄	B ₁	B ₂	B ₄	C ₁	C ₂	C ₄
34 250 to 34 350	0	1	1	0	0	1	0	0	1	0	0	1	0	0
34 350 to 34 450	0	1	1	0	0	1	0	0	1	0	0	1	1	0
34 450 to 34 550	0	1	1	0	0	1	0	0	1	0	0	0	1	0
34 550 to 34 650	0	1	1	0	0	1	0	0	1	0	0	0	1	1
34 650 to 34 750	0	1	1	0	0	1	0	0	1	0	0	0	0	1
34 750 to 34 850	0	1	1	0	1	1	1	0	0	0	0	0	0	1
34 850 to 34 950	0	1	1	0	1	1	1	0	0	0	0	0	1	1
34 950 to 35 050	0	1	1	0	1	1	1	0	0	0	0	0	1	0
35 050 to 35 150	0	1	1	0	1	1	1	0	0	0	1	1	1	0
35 150 to 35 250	0	1	1	0	1	1	1	0	0	0	1	0	0	0
35 250 to 35 350	0	1	1	0	1	1	1	0	1	1	1	0	0	0
35 350 to 35 450	0	1	1	0	1	1	1	0	1	1	1	1	1	0
35 450 to 35 550	0	1	1	0	1	1	1	0	1	1	0	1	0	0
35 550 to 35 650	0	1	1	0	1	1	1	0	1	1	0	1	1	1
35 650 to 35 750	0	1	1	0	1	1	1	0	1	1	0	0	0	1
35 750 to 35 850	0	1	1	0	1	1	1	1	1	1	0	0	0	1
35 850 to 35 950	0	1	1	0	1	1	1	1	1	1	0	1	1	1
35 950 to 36 050	0	1	1	0	1	1	1	1	1	1	0	1	0	0
36 050 to 36 150	0	1	1	0	1	1	1	1	1	1	1	1	1	0
36 150 to 36 250	0	1	1	0	1	1	1	1	1	1	1	1	0	0
36 250 to 36 350	0	1	1	0	1	1	1	1	0	1	1	0	0	0
36 350 to 36 450	0	1	1	0	1	1	1	1	0	1	1	1	1	0
36 450 to 36 550	0	1	1	0	1	1	1	1	0	1	0	1	0	0
36 550 to 36 650	0	1	1	0	1	1	1	1	0	1	0	1	1	1
36 650 to 36 750	0	1	1	0	1	1	1	1	0	1	0	0	0	1
36 750 to 36 850	0	1	1	0	1	0	1	0	1	0	0	0	0	1
36 850 to 36 950	0	1	1	0	1	0	1	0	1	0	0	0	1	1
36 950 to 37 050	0	1	1	0	1	0	1	0	1	0	0	0	1	0
37 050 to 37 150	0	1	1	0	1	0	1	0	1	0	1	1	1	0
37 150 to 37 250	0	1	1	0	1	0	1	0	1	0	1	0	0	0
37 250 to 37 350	0	1	1	0	1	0	1	0	1	1	1	1	0	0
37 350 to 37 450	0	1	1	0	1	0	1	0	1	1	1	1	1	0
37 450 to 37 550	0	1	1	0	1	0	1	0	1	1	0	1	0	0
37 550 to 37 650	0	1	1	0	1	0	1	0	1	1	0	1	1	1
37 650 to 37 750	0	1	1	0	1	0	1	0	1	1	0	0	0	1
37 750 to 37 850	0	1	1	0	1	0	0	0	1	0	0	0	0	1
37 850 to 37 950	0	1	1	0	1	0	0	0	1	0	0	1	1	1
37 950 to 38 050	0	1	1	0	1	0	0	0	1	0	0	1	0	0
38 050 to 38 150	0	1	1	0	1	0	0	0	1	1	1	1	1	0
38 150 to 38 250	0	1	1	0	1	0	0	0	1	1	0	0	0	0
38 250 to 38 350	0	1	1	0	1	0	0	0	0	1	0	0	0	0
38 350 to 38 450	0	1	1	0	1	0	0	0	0	1	1	1	0	0
38 450 to 38 550	0	1	1	0	1	0	0	0	0	0	0	1	0	0
38 550 to 38 650	0	1	1	0	1	0	0	0	0	0	0	1	1	1
38 650 to 38 750	0	1	1	0	1	0	0	0	0	0	0	0	0	1

RANGE	PULSE POSITIONS (0 or 1 in a pulse position denotes absence or presence of a pulse, respectively)												
	Increments (Feet)			D ₂	D ₄	A ₁	A ₂	A ₄	B ₁	B ₂	B ₄	C ₁	C ₂
38 750 to 38 850	0	1	1	1	1	0	0	0	0	0	0	0	1
38 850 to 38 950	0	1	1	1	1	0	0	0	0	0	0	1	1
38 950 to 39 050	0	1	1	1	1	0	0	0	0	0	0	1	0
39 050 to 39 150	0	1	1	1	1	0	0	0	0	0	1	1	0
39 150 to 39 250	0	1	1	1	1	0	0	0	0	0	1	0	0
39 250 to 39 350	0	1	1	1	1	0	0	1	0	0	1	0	0
39 350 to 39 450	0	1	1	1	1	0	0	1	0	0	1	1	0
39 450 to 39 550	0	1	1	1	1	0	0	1	0	0	1	0	0
39 550 to 39 650	0	1	1	1	1	0	0	1	0	0	1	1	1
39 650 to 39 750	0	1	1	1	1	0	0	1	0	0	1	0	1
39 750 to 39 850	0	1	1	1	1	0	1	1	0	1	1	0	1
39 850 to 39 950	0	1	1	1	1	0	1	1	0	1	1	0	1
39 950 to 40 050	0	1	1	1	1	0	1	1	0	1	1	0	0
40 050 to 40 150	0	1	1	1	1	0	1	1	0	1	1	1	0
40 150 to 40 250	0	1	1	1	1	0	1	1	0	1	1	0	0
40 250 to 40 350	0	1	1	1	1	0	1	0	0	1	0	0	0
40 350 to 40 450	0	1	1	1	1	0	1	0	0	1	0	1	0
40 450 to 40 550	0	1	1	1	1	0	1	0	0	1	0	1	0
40 550 to 40 650	0	1	1	1	1	0	1	0	0	1	0	1	1
40 650 to 40 750	0	1	1	1	1	0	1	0	0	1	0	0	1
40 750 to 40 850	0	1	1	1	1	1	1	0	0	1	0	0	1
40 850 to 40 950	0	1	1	1	1	1	1	0	0	1	0	1	1
40 950 to 41 050	0	1	1	1	1	1	1	0	0	1	0	1	0
41 050 to 41 150	0	1	1	1	1	1	1	0	0	1	1	1	0
41 150 to 41 250	0	1	1	1	1	1	1	0	0	1	1	0	0
41 250 to 41 350	0	1	1	1	1	1	1	1	0	1	1	0	0
41 350 to 41 450	0	1	1	1	1	1	1	1	0	1	1	1	0
41 450 to 41 550	0	1	1	1	1	1	1	1	0	1	0	1	0
41 550 to 41 650	0	1	1	1	1	1	1	1	0	1	0	1	1
41 650 to 41 750	0	1	1	1	1	1	1	1	0	1	0	0	1
41 750 to 41 850	0	1	1	1	1	1	0	1	0	1	0	0	1
41 850 to 41 950	0	1	1	1	1	1	0	1	0	1	0	1	1
41 950 to 42 050	0	1	1	1	1	1	0	1	0	1	0	1	0
42 050 to 42 150	0	1	1	1	1	1	0	1	0	1	1	1	0
42 150 to 42 250	0	1	1	1	1	1	0	1	0	1	1	0	0
42 250 to 42 350	0	1	1	1	1	1	0	0	0	0	1	0	0
42 350 to 42 450	0	1	1	1	1	1	0	0	0	0	1	1	0
42 450 to 42 550	0	1	1	1	1	1	0	0	0	0	0	1	0
42 550 to 42 650	0	1	1	1	1	1	0	0	0	0	0	1	1
42 650 to 42 750	0	1	1	1	1	1	0	0	0	0	0	0	1
42 750 to 42 850	0	1	1	1	0	1	0	0	0	0	0	0	1
42 850 to 42 950	0	1	1	1	0	1	0	0	0	0	0	1	1
42 950 to 43 050	0	1	1	1	0	1	0	0	0	0	0	1	0
43 050 to 43 150	0	1	1	1	0	1	0	0	0	0	1	1	0
43 150 to 43 250	0	1	1	1	0	1	0	0	0	0	1	0	0

RANGE	PULSE POSITIONS (0 or 1 in a pulse position denotes absence or presence of a pulse, respectively)												
	Increments (Feet)			D ₂	D ₄	A ₁	A ₂	A ₄	B ₁	B ₂	B ₄	C ₁	C ₂
43 250 to 43 350	0	1	1	1	0	1	0	1	0	1	1	0	0
43 350 to 43 450	0	1	1	1	0	1	0	1	0	1	1	1	0
43 450 to 43 550	0	1	1	1	0	1	0	1	0	1	0	1	0
43 550 to 43 650	0	1	1	1	0	1	0	1	0	1	0	1	1
43 650 to 43 750	0	1	1	1	0	1	0	1	0	1	0	0	1
43 750 to 43 850	0	1	1	1	0	1	1	1	1	1	0	0	1
43 850 to 43 950	0	1	1	1	0	1	1	1	1	1	0	1	1
43 950 to 44 050	0	1	1	1	0	1	1	1	1	1	0	1	0
44 050 to 44 150	0	1	1	1	0	1	1	1	1	1	1	1	0
44 150 to 44 250	0	1	1	1	0	1	1	1	1	1	1	0	0
44 250 to 44 350	0	1	1	1	0	1	1	0	1	1	0	1	0
44 350 to 44 450	0	1	1	1	0	1	1	0	1	1	0	1	0
44 450 to 44 550	0	1	1	1	0	1	1	0	1	1	0	0	1
44 550 to 44 650	0	1	1	1	0	1	1	0	1	1	0	1	1
44 650 to 44 750	0	1	1	1	0	1	1	0	1	1	0	0	1
44 750 to 44 850	0	1	1	1	0	0	1	0	0	1	0	0	1
44 850 to 44 950	0	1	1	1	0	0	1	0	0	1	0	1	1
44 950 to 45 050	0	1	1	1	0	0	1	0	0	1	0	1	0
45 050 to 45 150	0	1	1	1	0	0	1	0	0	1	1	1	0
45 150 to 45 250	0	1	1	1	0	0	1	0	0	1	1	0	0
45 250 to 45 350	0	1	1	1	0	0	1	1	1	1	1	0	0
45 350 to 45 450	0	1	1	1	0	0	1	1	1	1	1	1	0
45 450 to 45 550	0	1	1	1	0	0	1	1	1	1	0	1	0
45 550 to 45 650	0	1	1	1	0	0	1	1	1	1	0	1	1
45 650 to 45 750	0	1	1	1	0	0	1	1	1	1	0	0	1
45 750 to 45 850	0	1	1	1	0	0	0	1	0	0	0	0	1
45 850 to 45 950	0	1	1	1	0	0	0	1	0	0	0	1	1
45 950 to 46 050	0	1	1	1	0	0	0	1	0	0	0	1	0
46 050 to 46 150	0	1	1	1	0	0	0	1	0	0	1	1	0
46 150 to 46 250	0	1	1	1	0	0	0	1	0	0	1	0	0
46 250 to 46 350	0	1	1	1	0	0	0	0	0	0	1	0	0
46 350 to 46 450	0	1	1	1	0	0	0	0	0	0	1	1	0
46 450 to 46 550	0	1	1	1	0	0	0	0	0	0	0	1	0
46 550 to 46 650	0	1	1	1	0	0	0	0	0	0	0	1	1
46 650 to 46 750	0	1	1	1	0	0	0	0	0	0	0	0	1
46 750 to 46 850	0	1	0	1	0	0	0	0	0	0	0	0	1
46 850 to 46 950	0	1	0	1	0	0	0	0	0	0	0	1	1
46 950 to 47 050	0	1	0	1	0	0	0	0	0	0	0	1	0
47 050 to 47 150	0	1	0	1	0	0	0	0	0	0	1	1	0
47 150 to 47 250	0	1	0	1	0	0	0	0	0	0	1	0	0
47 250 to 47 350	0	1	0	1	0	0	0	1	0	0	1	0	0
47 350 to 47 450	0	1	0	1	0	0	0	1	0	0	1	1	0
47 450 to 47 550	0	1	0	1	0	0	0	1	0	0	0	1	0
47 550 to 47 650	0	1	0	1	0	0	0	1	0	0	0	1	1
47 650 to 47 750	0	1	0	1	0	0	0	1	0	0	0	0	1

RANGE	PULSE POSITIONS (0 or 1 in a pulse position denotes absence or presence of a pulse, respectively)													
	Increments (Feet)			D ₂	D ₄	A ₁	A ₂	A ₄	B ₁	B ₂	B ₄	C ₁	C ₂	C ₄
47 750 to 47 850	0	1	0	1	0	0	1	1	0	0	1	0	0	1
47 850 to 47 950	0	1	0	1	0	0	1	1	0	0	1	0	1	1
47 950 to 48 050	0	1	0	1	0	0	1	1	0	0	1	0	1	0
48 050 to 48 150	0	1	0	1	0	0	1	1	0	0	1	1	1	0
48 150 to 48 250	0	1	0	1	0	0	1	1	0	0	1	1	0	0
48 250 to 48 350	0	1	0	1	0	0	1	0	0	1	0	1	0	0
48 350 to 48 450	0	1	0	1	0	0	1	0	0	1	0	1	1	0
48 450 to 48 550	0	1	0	1	0	0	1	0	0	1	0	0	1	0
48 550 to 48 650	0	1	0	1	0	0	1	0	0	1	0	0	1	1
48 650 to 48 750	0	1	0	1	0	0	1	0	0	1	0	0	0	1
48 750 to 48 850	0	1	0	1	0	1	1	1	0	1	1	0	0	1
48 850 to 48 950	0	1	0	1	0	1	1	1	0	1	1	0	1	1
48 950 to 49 050	0	1	0	1	0	1	1	1	0	1	1	0	1	0
49 050 to 49 150	0	1	0	1	0	1	1	1	0	1	1	1	1	0
49 150 to 49 250	0	1	0	1	0	1	1	1	0	1	1	1	0	0
49 250 to 49 350	0	1	0	1	0	1	1	1	1	1	1	1	0	0
49 350 to 49 450	0	1	0	1	0	1	1	1	1	1	1	1	1	0
49 450 to 49 550	0	1	0	1	0	1	1	1	1	1	1	0	1	0
49 550 to 49 650	0	1	0	1	0	1	1	1	1	1	1	0	1	1
49 650 to 49 750	0	1	0	1	0	1	1	1	1	1	1	0	0	1
49 750 to 49 850	0	1	0	1	0	1	0	1	0	1	0	0	0	1
49 850 to 49 950	0	1	0	1	0	1	0	1	0	1	0	0	1	1
49 950 to 50 050	0	1	0	1	0	1	0	1	0	1	0	0	1	0
50 050 to 50 150	0	1	0	1	0	1	0	1	0	1	1	1	1	0
50 150 to 50 250	0	1	0	1	0	1	0	1	0	1	1	1	0	0
50 250 to 50 350	0	1	0	1	0	1	0	1	0	0	1	0	0	0
50 350 to 50 450	0	1	0	1	0	1	0	1	0	0	1	1	1	0
50 450 to 50 550	0	1	0	1	0	1	0	1	0	0	0	1	1	0
50 550 to 50 650	0	1	0	1	0	1	0	1	0	0	0	1	1	1
50 650 to 50 750	0	1	0	1	0	1	0	1	0	0	0	0	0	1
50 750 to 50 850	0	1	0	1	1	1	1	0	0	0	0	0	0	1
50 850 to 50 950	0	1	0	1	1	1	1	0	0	0	0	0	1	1
50 950 to 51 050	0	1	0	1	1	1	1	0	0	0	0	0	1	0
51 050 to 51 150	0	1	0	1	1	1	1	0	0	0	1	1	1	0
51 150 to 51 250	0	1	0	1	1	1	1	0	0	0	1	0	0	0
51 250 to 51 350	0	1	0	1	1	1	1	0	1	1	1	0	0	0
51 350 to 51 450	0	1	0	1	1	1	1	0	1	1	1	1	1	0
51 450 to 51 550	0	1	0	1	1	1	1	0	1	0	0	1	1	0
51 550 to 51 650	0	1	0	1	1	1	1	0	1	0	0	1	1	1
51 650 to 51 750	0	1	0	1	1	1	1	0	1	0	0	0	0	1
51 750 to 51 850	0	1	0	1	1	1	1	1	1	1	0	0	0	1
51 850 to 51 950	0	1	0	1	1	1	1	1	1	1	0	1	1	1
51 950 to 52 050	0	1	0	1	1	1	1	1	1	1	0	1	1	0
52 050 to 52 150	0	1	0	1	1	1	1	1	1	1	1	1	1	0
52 150 to 52 250	0	1	0	1	1	1	1	1	1	1	1	1	0	0

RANGE	PULSE POSITIONS (0 or 1 in a pulse position denotes absence or presence of a pulse, respectively)												
	Increments (Feet)			D ₂	D ₄	A ₁	A ₂	A ₄	B ₁	B ₂	B ₄	C ₁	C ₂
52 250 to 52 350	0	1	0	1	1	1	1	1	0	1	0	0	0
52 350 to 52 450	0	1	0	1	1	1	1	1	0	1	1	0	0
52 450 to 52 550	0	1	0	1	1	1	1	1	0	0	1	0	0
52 550 to 52 650	0	1	0	1	1	1	1	1	0	0	1	1	1
52 650 to 52 750	0	1	0	1	1	1	1	1	0	0	0	1	1
52 750 to 52 850	0	1	0	1	1	0	1	0	1	0	0	0	1
52 850 to 52 950	0	1	0	1	1	0	1	0	1	0	0	1	1
52 950 to 53 050	0	1	0	1	1	0	1	0	1	0	0	1	0
53 050 to 53 150	0	1	0	1	1	0	1	0	1	0	1	1	0
53 150 to 53 250	0	1	0	1	1	0	1	0	1	0	1	0	0
53 250 to 53 350	0	1	0	1	1	0	1	1	1	1	1	0	0
53 350 to 53 450	0	1	0	1	1	0	1	1	1	1	1	1	0
53 450 to 53 550	0	1	0	1	1	0	1	1	1	0	1	0	0
53 550 to 53 650	0	1	0	1	1	0	1	1	1	0	1	1	1
53 650 to 53 750	0	1	0	1	1	0	1	1	1	0	0	0	1
53 750 to 53 850	0	1	0	1	1	0	0	0	1	0	0	0	1
53 850 to 53 950	0	1	0	1	1	0	0	0	1	0	1	1	1
53 950 to 54 050	0	1	0	1	1	0	0	0	1	0	1	0	0
54 050 to 54 150	0	1	0	1	1	0	0	0	1	1	1	0	0
54 150 to 54 250	0	1	0	1	1	0	0	0	1	1	0	0	0
54 250 to 54 350	0	1	0	1	1	0	0	0	0	1	0	0	0
54 350 to 54 450	0	1	0	1	1	0	0	0	0	1	1	0	0
54 450 to 54 550	0	1	0	1	1	0	0	0	0	0	1	0	0
54 550 to 54 650	0	1	0	1	1	0	0	0	0	0	1	1	1
54 650 to 54 750	0	1	0	1	1	0	0	0	0	0	0	0	1
54 750 to 54 850	0	1	0	0	1	0	0	0	0	0	0	0	1
54 850 to 54 950	0	1	0	0	1	0	0	0	0	0	1	1	1
54 950 to 55 050	0	1	0	0	1	0	0	0	0	0	1	0	0
55 050 to 55 150	0	1	0	0	1	0	0	0	0	1	1	0	0
55 150 to 55 250	0	1	0	0	1	0	0	0	0	1	0	0	0
55 250 to 55 350	0	1	0	0	1	0	0	0	1	1	0	0	0
55 350 to 55 450	0	1	0	0	1	0	0	0	1	1	1	0	0
55 450 to 55 550	0	1	0	0	1	0	0	0	1	0	1	0	0
55 550 to 55 650	0	1	0	0	1	0	0	0	1	0	1	1	1
55 650 to 55 750	0	1	0	0	1	0	0	0	1	0	0	0	1
55 750 to 55 850	0	1	0	0	1	0	1	1	1	0	0	0	1
55 850 to 55 950	0	1	0	0	1	0	1	1	1	0	1	1	1
55 950 to 56 050	0	1	0	0	1	0	1	1	1	0	1	0	0
56 050 to 56 150	0	1	0	0	1	0	1	1	1	1	1	0	0
56 150 to 56 250	0	1	0	0	1	0	1	1	1	1	0	0	0
56 250 to 56 350	0	1	0	0	1	0	1	0	0	1	0	0	0
56 350 to 56 450	0	1	0	0	1	0	1	0	0	1	1	0	0
56 450 to 56 550	0	1	0	0	1	0	1	0	0	0	1	0	0
56 550 to 56 650	0	1	0	0	1	0	1	0	0	0	1	1	1
56 650 to 56 750	0	1	0	0	1	0	1	0	0	0	0	0	1

RANGE	PULSE POSITIONS (0 or 1 in a pulse position denotes absence or presence of a pulse, respectively)												
	Increments (Feet)		D ₂	D ₄	A ₁	A ₂	A ₄	B ₁	B ₂	B ₄	C ₁	C ₂	C ₄
56 750	to	56 850	0	1	0	0	1	1	1	0	0	0	1
56 850	to	56 950	0	1	0	0	1	1	1	0	0	1	1
56 950	to	57 050	0	1	0	0	1	1	1	0	0	1	0
57 050	to	57 150	0	1	0	0	1	1	1	0	1	1	0
57 150	to	57 250	0	1	0	0	1	1	1	0	1	0	0
57 250	to	57 350	0	1	0	0	1	1	1	1	1	0	0
57 350	to	57 450	0	1	0	0	1	1	1	1	1	1	0
57 450	to	57 550	0	1	0	0	1	1	1	1	0	1	0
57 550	to	57 650	0	1	0	0	1	1	1	1	0	1	1
57 650	to	57 750	0	1	0	0	1	1	1	1	0	0	1
57 750	to	57 850	0	1	0	0	1	1	0	1	0	0	1
57 850	to	57 950	0	1	0	0	1	1	0	1	0	1	1
57 950	to	58 050	0	1	0	0	1	1	0	1	0	1	0
58 050	to	58 150	0	1	0	0	1	1	0	1	1	1	0
58 150	to	58 250	0	1	0	0	1	1	0	1	1	0	0
58 250	to	58 350	0	1	0	0	1	1	0	0	1	0	0
58 350	to	58 450	0	1	0	0	1	1	0	0	1	1	0
58 450	to	58 550	0	1	0	0	1	1	0	0	0	1	0
58 550	to	58 650	0	1	0	0	1	1	0	0	0	1	1
58 650	to	58 750	0	1	0	0	1	1	0	0	0	0	1
58 750	to	58 850	0	1	0	0	0	1	0	0	0	0	1
58 850	to	58 950	0	1	0	0	0	1	0	0	0	1	1
58 950	to	59 050	0	1	0	0	0	1	0	0	0	1	0
59 050	to	59 150	0	1	0	0	0	1	0	0	1	1	0
59 150	to	59 250	0	1	0	0	0	1	0	0	1	0	0
59 250	to	59 350	0	1	0	0	0	1	0	1	1	0	0
59 350	to	59 450	0	1	0	0	0	1	0	1	1	1	0
59 450	to	59 550	0	1	0	0	0	1	0	1	0	1	0
59 550	to	59 650	0	1	0	0	0	1	0	1	0	1	1
59 650	to	59 750	0	1	0	0	0	1	0	1	0	0	1
59 750	to	59 850	0	1	0	0	0	1	1	1	0	0	1
59 850	to	59 950	0	1	0	0	0	1	1	1	0	1	1
59 950	to	60 050	0	1	0	0	0	1	1	1	0	1	0
60 050	to	60 150	0	1	0	0	0	1	1	1	1	1	0
60 150	to	60 250	0	1	0	0	0	1	1	1	1	0	0
60 250	to	60 350	0	1	0	0	0	1	1	0	1	0	0
60 350	to	60 450	0	1	0	0	0	1	1	0	1	1	0
60 450	to	60 550	0	1	0	0	0	1	1	0	0	1	0
60 550	to	60 650	0	1	0	0	0	1	1	0	0	1	1
60 650	to	60 750	0	1	0	0	0	1	1	0	0	0	1
60 750	to	60 850	0	1	0	0	0	0	1	0	0	0	1
60 850	to	60 950	0	1	0	0	0	0	1	0	0	1	1
60 950	to	61 050	0	1	0	0	0	0	1	0	0	1	0
61 050	to	61 150	0	1	0	0	0	0	1	0	1	1	0
61 150	to	61 250	0	1	0	0	0	0	1	0	1	0	0

RANGE	PULSE POSITIONS (0 or 1 in a pulse position denotes absence or presence of a pulse, respectively)												
	Increments (Feet)			D ₂	D ₄	A ₁	A ₂	A ₄	B ₁	B ₂	B ₄	C ₁	C ₂
61 250 to 61 350	0	1	0	0	0	0	0	0	1	1	1	0	0
61 350 to 61 450	0	1	0	0	0	0	0	0	1	1	1	1	0
61 450 to 61 550	0	1	0	0	0	0	0	0	1	1	0	1	0
61 550 to 61 650	0	1	0	0	0	0	0	0	1	1	0	1	1
61 650 to 61 750	0	1	0	0	0	0	0	0	1	1	0	0	1
61 750 to 61 850	0	1	0	0	0	0	0	0	0	1	0	0	1
61 850 to 61 950	0	1	0	0	0	0	0	0	0	1	0	1	1
61 950 to 62 050	0	1	0	0	0	0	0	0	0	1	0	1	0
62 050 to 62 150	0	1	0	0	0	0	0	0	0	1	1	1	0
62 150 to 62 250	0	1	0	0	0	0	0	0	0	1	1	0	0
62 250 to 62 350	0	1	0	0	0	0	0	0	0	0	1	0	0
62 350 to 62 450	0	1	0	0	0	0	0	0	0	0	1	1	0
62 450 to 62 550	0	1	0	0	0	0	0	0	0	0	0	1	0
62 550 to 62 650	0	1	0	0	0	0	0	0	0	0	0	1	1
62 650 to 62 750	0	1	0	0	0	0	0	0	0	0	0	0	1
62 750 to 62 850	1	1	0	0	0	0	0	0	0	0	0	0	1
62 850 to 62 950	1	1	0	0	0	0	0	0	0	0	0	1	1
62 950 to 63 050	1	1	0	0	0	0	0	0	0	0	0	1	0
63 050 to 63 150	1	1	0	0	0	0	0	0	0	0	1	1	0
63 150 to 63 250	1	1	0	0	0	0	0	0	0	0	1	0	0
63 250 to 63 350	1	1	0	0	0	0	0	0	0	1	1	0	0
63 350 to 63 450	1	1	0	0	0	0	0	0	0	1	1	1	0
63 450 to 63 550	1	1	0	0	0	0	0	0	0	1	0	1	0
63 550 to 63 650	1	1	0	0	0	0	0	0	0	1	0	1	1
63 650 to 63 750	1	1	0	0	0	0	0	0	0	1	0	0	1
63 750 to 63 850	1	1	0	0	0	0	0	1	1	1	0	0	1
63 850 to 63 950	1	1	0	0	0	0	0	1	1	1	0	1	1
63 950 to 64 050	1	1	0	0	0	0	0	1	1	1	0	1	0
64 050 to 64 150	1	1	0	0	0	0	0	1	1	1	1	1	0
64 150 to 64 250	1	1	0	0	0	0	0	1	1	1	1	0	0
64 250 to 64 350	1	1	0	0	0	0	0	1	0	0	1	0	0
64 350 to 64 450	1	1	0	0	0	0	0	1	0	0	1	1	0
64 450 to 64 550	1	1	0	0	0	0	0	1	0	0	0	1	0
64 550 to 64 650	1	1	0	0	0	0	0	1	0	0	0	1	1
64 650 to 64 750	1	1	0	0	0	0	0	1	0	0	0	0	1
64 750 to 64 850	1	1	0	0	0	1	1	0	0	0	0	0	1
64 850 to 64 950	1	1	0	0	0	1	1	0	0	0	0	1	1
64 950 to 65 050	1	1	0	0	0	1	1	0	0	0	0	1	0
65 050 to 65 150	1	1	0	0	0	1	1	0	1	1	1	1	0
65 150 to 65 250	1	1	0	0	0	1	1	0	1	1	1	0	0
65 250 to 65 350	1	1	0	0	0	1	1	1	1	1	1	0	0
65 350 to 65 450	1	1	0	0	0	1	1	1	1	1	1	1	0
65 450 to 65 550	1	1	0	0	0	1	1	1	1	1	0	1	0
65 550 to 65 650	1	1	0	0	0	1	1	1	1	1	0	1	1
65 650 to 65 750	1	1	0	0	0	1	1	1	1	1	0	0	1

RANGE	PULSE POSITIONS (0 or 1 in a pulse position denotes absence or presence of a pulse, respectively)												
	Increments (Feet)			D ₂	D ₄	A ₁	A ₂	A ₄	B ₁	B ₂	B ₄	C ₁	C ₂
65 750 to 65 850	1	1	0	0	0	1	0	1	0	1	0	0	1
65 850 to 65 950	1	1	0	0	0	1	0	1	0	1	0	1	1
65 950 to 66 050	1	1	0	0	0	1	0	1	0	1	0	1	0
66 050 to 66 150	1	1	0	0	0	1	0	1	0	1	1	1	0
66 150 to 66 250	1	1	0	0	0	1	0	1	0	1	1	0	0
66 250 to 66 350	1	1	0	0	0	1	0	0	1	0	1	0	0
66 350 to 66 450	1	1	0	0	0	1	0	0	1	0	1	1	0
66 450 to 66 550	1	1	0	0	0	1	0	0	1	0	0	1	0
66 550 to 66 650	1	1	0	0	0	1	0	0	1	0	0	1	1
66 650 to 66 750	1	1	0	0	0	1	0	0	1	0	0	0	1
66 750 to 66 850	1	1	0	0	1	1	1	0	0	0	0	0	1
66 850 to 66 950	1	1	0	0	1	1	1	0	0	0	0	1	1
66 950 to 67 050	1	1	0	0	1	1	1	0	0	0	0	1	0
67 050 to 67 150	1	1	0	0	1	1	1	0	0	0	1	1	0
67 150 to 67 250	1	1	0	0	1	1	1	0	0	0	1	0	0
67 250 to 67 350	1	1	0	0	1	1	1	0	1	1	1	0	0
67 350 to 67 450	1	1	0	0	1	1	1	0	1	1	1	1	0
67 450 to 67 550	1	1	0	0	1	1	1	0	1	1	0	1	0
67 550 to 67 650	1	1	0	0	1	1	1	0	1	1	0	1	1
67 650 to 67 750	1	1	0	0	1	1	1	0	1	1	0	0	1
67 750 to 67 850	1	1	0	0	1	1	1	1	1	1	0	0	1
67 850 to 67 950	1	1	0	0	1	1	1	1	1	1	0	1	1
67 950 to 68 050	1	1	0	0	1	1	1	1	1	1	0	1	0
68 050 to 68 150	1	1	0	0	1	1	1	1	1	1	1	1	0
68 150 to 68 250	1	1	0	0	1	1	1	1	1	1	1	0	0
68 250 to 68 350	1	1	0	0	1	1	1	1	0	1	1	0	0
68 350 to 68 450	1	1	0	0	1	1	1	1	0	1	1	1	0
68 450 to 68 550	1	1	0	0	1	1	1	1	0	0	1	1	0
68 550 to 68 650	1	1	0	0	1	1	1	1	0	0	1	1	1
68 650 to 68 750	1	1	0	0	1	1	1	1	0	0	0	0	1
68 750 to 68 850	1	1	0	0	1	0	1	0	1	0	0	0	1
68 850 to 68 950	1	1	0	0	1	0	1	0	1	0	0	1	1
68 950 to 69 050	1	1	0	0	1	0	1	0	1	0	0	1	0
69 050 to 69 150	1	1	0	0	1	0	1	0	1	0	1	1	0
69 150 to 69 250	1	1	0	0	1	0	1	0	1	0	1	0	0
69 250 to 69 350	1	1	0	0	1	0	1	1	1	1	1	0	0
69 350 to 69 450	1	1	0	0	1	0	1	1	1	1	1	1	0
69 450 to 69 550	1	1	0	0	1	0	1	1	1	0	1	1	0
69 550 to 69 650	1	1	0	0	1	0	1	1	1	0	1	1	1
69 650 to 69 750	1	1	0	0	1	0	1	1	1	0	0	0	1
69 750 to 69 850	1	1	0	0	1	0	0	1	0	0	0	0	1
69 850 to 69 950	1	1	0	0	1	0	0	1	0	0	0	1	1
69 950 to 70 050	1	1	0	0	1	0	0	1	0	0	0	1	0
70 050 to 70 150	1	1	0	0	1	0	0	1	0	0	1	1	0
70 150 to 70 250	1	1	0	0	1	0	0	1	0	0	1	0	0

RANGE	PULSE POSITIONS (0 or 1 in a pulse position denotes absence or presence of a pulse, respectively)												
	Increments (Feet)			D ₂	D ₄	A ₁	A ₂	A ₄	B ₁	B ₂	B ₄	C ₁	C ₂
70 250 to 70 350	1	1	0	0	1	0	0	0	0	0	1	0	0
70 350 to 70 450	1	1	0	0	1	0	0	0	0	0	1	1	0
70 450 to 70 550	1	1	0	0	1	0	0	0	0	0	0	1	0
70 550 to 70 650	1	1	0	0	1	0	0	0	0	0	0	1	1
70 650 to 70 750	1	1	0	0	1	0	0	0	0	0	0	0	1
70 750 to 70 850	1	1	0	1	1	0	0	0	0	0	0	0	1
70 850 to 70 950	1	1	0	1	1	0	0	0	0	0	0	1	1
70 950 to 71 050	1	1	0	1	1	0	0	0	0	0	0	1	0
71 050 to 71 150	1	1	0	1	1	0	0	0	0	0	1	1	0
71 150 to 71 250	1	1	0	1	1	0	0	0	0	0	1	0	0
71 250 to 71 350	1	1	0	1	1	0	0	0	1	1	1	0	0
71 350 to 71 450	1	1	0	1	1	0	0	0	1	1	1	1	0
71 450 to 71 550	1	1	0	1	1	0	0	0	1	0	1	1	0
71 550 to 71 650	1	1	0	1	1	0	0	0	1	0	1	1	1
71 650 to 71 750	1	1	0	1	1	0	0	0	1	0	0	0	1
71 750 to 71 850	1	1	0	1	1	0	1	1	1	0	0	0	1
71 850 to 71 950	1	1	0	1	1	0	1	1	1	0	1	1	1
71 950 to 72 050	1	1	0	1	1	0	1	1	1	0	1	1	0
72 050 to 72 150	1	1	0	1	1	0	1	1	1	1	1	1	0
72 150 to 72 250	1	1	0	1	1	0	1	1	1	1	1	0	0
72 250 to 72 350	1	1	0	1	1	0	1	0	1	0	1	0	0
72 350 to 72 450	1	1	0	1	1	0	1	0	1	0	1	1	0
72 450 to 72 550	1	1	0	1	1	0	1	0	1	0	0	1	0
72 550 to 72 650	1	1	0	1	1	0	1	0	1	0	0	1	1
72 650 to 72 750	1	1	0	1	1	0	1	0	1	0	0	0	1
72 750 to 72 850	1	1	0	1	1	1	1	0	1	0	0	0	1
72 850 to 72 950	1	1	0	1	1	1	1	0	1	0	0	1	1
72 950 to 73 050	1	1	0	1	1	1	1	0	1	0	0	1	0
73 050 to 73 150	1	1	0	1	1	1	1	0	1	0	1	1	0
73 150 to 73 250	1	1	0	1	1	1	1	0	1	0	1	0	0
73 250 to 73 350	1	1	0	1	1	1	1	1	1	1	1	0	0
73 350 to 73 450	1	1	0	1	1	1	1	1	1	1	1	1	0
73 450 to 73 550	1	1	0	1	1	1	1	1	1	1	0	1	0
73 550 to 73 650	1	1	0	1	1	1	1	1	1	1	0	1	1
73 650 to 73 750	1	1	0	1	1	1	1	1	1	1	0	0	1
73 750 to 73 850	1	1	0	1	1	1	0	1	0	1	0	0	1
73 850 to 73 950	1	1	0	1	1	1	0	1	0	1	0	1	1
73 950 to 74 050	1	1	0	1	1	1	0	1	0	1	0	1	0
74 050 to 74 150	1	1	0	1	1	1	0	1	0	1	1	1	0
74 150 to 74 250	1	1	0	1	1	1	0	1	0	1	1	0	0
74 250 to 74 350	1	1	0	1	1	1	0	0	0	0	1	0	0
74 350 to 74 450	1	1	0	1	1	1	0	0	0	0	1	1	0
74 450 to 74 550	1	1	0	1	1	1	0	0	0	0	0	1	0
74 550 to 74 650	1	1	0	1	1	1	0	0	0	0	0	1	1
74 650 to 74 750	1	1	0	1	1	1	0	0	0	0	0	0	1

RANGE	PULSE POSITIONS (0 or 1 in a pulse position denotes absence or presence of a pulse, respectively)												
	Increments (Feet)			D ₂	D ₄	A ₁	A ₂	A ₄	B ₁	B ₂	B ₄	C ₁	C ₂
74 750 to 74 850	1	1	0	1	0	1	0	0	0	0	0	0	1
74 850 to 74 950	1	1	0	1	0	1	0	1	0	0	0	1	1
74 950 to 75 050	1	1	0	1	0	1	0	1	0	0	0	1	0
75 050 to 75 150	1	1	0	1	0	1	0	1	0	0	1	1	0
75 150 to 75 250	1	1	0	1	0	1	0	1	0	0	1	0	0
75 250 to 75 350	1	1	0	1	0	1	0	1	0	1	1	0	0
75 350 to 75 450	1	1	0	1	0	1	0	1	0	1	1	1	0
75 450 to 75 550	1	1	0	1	0	1	0	1	0	1	0	1	0
75 550 to 75 650	1	1	0	1	0	1	0	1	0	1	0	1	1
75 650 to 75 750	1	1	0	1	0	1	0	1	0	1	0	0	1
75 750 to 75 850	1	1	0	1	0	1	0	1	1	1	0	0	1
75 850 to 75 950	1	1	0	1	0	1	0	1	1	1	0	1	1
75 950 to 76 050	1	1	0	1	0	1	0	1	1	1	0	1	0
76 050 to 76 150	1	1	0	1	0	1	0	1	1	1	1	1	0
76 150 to 76 250	1	1	0	1	0	1	0	1	1	1	1	0	0
76 250 to 76 350	1	1	0	1	0	1	0	1	1	0	1	0	0
76 350 to 76 450	1	1	0	1	0	1	0	1	1	0	1	1	0
76 450 to 76 550	1	1	0	1	0	1	0	1	1	0	0	1	0
76 550 to 76 650	1	1	0	1	0	1	0	1	1	0	0	1	1
76 650 to 76 750	1	1	0	1	0	1	0	1	1	0	0	0	1
76 750 to 76 850	1	1	0	1	0	0	0	1	0	0	0	0	1
76 850 to 76 950	1	1	0	1	0	0	0	1	0	0	0	1	1
76 950 to 77 050	1	1	0	1	0	0	0	1	0	0	0	1	0
77 050 to 77 150	1	1	0	1	0	0	0	1	0	0	1	1	0
77 150 to 77 250	1	1	0	1	0	0	0	1	0	0	1	0	0
77 250 to 77 350	1	1	0	1	0	0	0	1	1	1	1	0	0
77 350 to 77 450	1	1	0	1	0	0	0	1	1	1	1	1	0
77 450 to 77 550	1	1	0	1	0	0	0	1	1	1	0	1	0
77 550 to 77 650	1	1	0	1	0	0	0	1	1	1	0	1	1
77 650 to 77 750	1	1	0	1	0	0	0	1	1	1	0	0	1
77 750 to 77 850	1	1	0	1	0	0	0	0	1	1	0	0	1
77 850 to 77 950	1	1	0	1	0	0	0	0	1	1	0	1	1
77 950 to 78 050	1	1	0	1	0	0	0	0	1	1	0	1	0
78 050 to 78 150	1	1	0	1	0	0	0	0	1	1	1	1	0
78 150 to 78 250	1	1	0	1	0	0	0	0	1	1	1	0	0
78 250 to 78 350	1	1	0	1	0	0	0	0	0	1	0	0	0
78 350 to 78 450	1	1	0	1	0	0	0	0	0	1	1	1	0
78 450 to 78 550	1	1	0	1	0	0	0	0	0	0	0	1	0
78 550 to 78 650	1	1	0	1	0	0	0	0	0	0	0	1	1
78 650 to 78 750	1	1	0	1	0	0	0	0	0	0	0	0	1
78 750 to 78 850	1	1	1	1	0	0	0	0	0	0	0	0	1
78 850 to 78 950	1	1	1	1	0	0	0	0	0	0	0	1	1
78 950 to 79 050	1	1	1	1	0	0	0	0	0	0	0	1	0
79 050 to 79 150	1	1	1	1	0	0	0	0	0	0	1	1	0
79 150 to 79 250	1	1	1	1	0	0	0	0	0	0	1	0	0

RANGE	PULSE POSITIONS (0 or 1 in a pulse position denotes absence or presence of a pulse, respectively)												
	Increments (Feet)			D ₂	D ₄	A ₁	A ₂	A ₄	B ₁	B ₂	B ₄	C ₁	C ₂
79 250 to 79 350	1	1	1	1	0	0	0	1	1	0	0	0	0
79 350 to 79 450	1	1	1	1	0	0	0	1	1	0	1	1	0
79 450 to 79 550	1	1	1	1	0	0	0	1	1	0	1	0	0
79 550 to 79 650	1	1	1	1	0	0	0	1	1	0	1	1	1
79 650 to 79 750	1	1	1	1	0	0	0	1	1	0	0	0	1
79 750 to 79 850	1	1	1	1	0	0	1	1	1	0	0	0	1
79 850 to 79 950	1	1	1	1	0	0	1	1	1	0	1	1	1
79 950 to 80 050	1	1	1	1	0	0	1	1	1	0	1	0	0
80 050 to 80 150	1	1	1	1	0	0	1	1	1	1	1	1	0
80 150 to 80 250	1	1	1	1	0	0	1	1	1	1	0	0	0
80 250 to 80 350	1	1	1	1	0	0	1	0	1	0	1	0	0
80 350 to 80 450	1	1	1	1	0	0	1	0	1	0	1	1	0
80 450 to 80 550	1	1	1	1	0	0	1	0	1	0	0	1	0
80 550 to 80 650	1	1	1	1	0	0	1	0	1	0	0	1	1
80 650 to 80 750	1	1	1	1	0	0	1	0	1	0	0	0	1
80 750 to 80 850	1	1	1	1	0	1	1	0	1	0	0	0	1
80 850 to 80 950	1	1	1	1	0	1	1	0	1	0	0	1	1
80 950 to 81 050	1	1	1	1	0	1	1	0	1	0	0	1	0
81 050 to 81 150	1	1	1	1	0	1	1	0	1	0	1	1	0
81 150 to 81 250	1	1	1	1	0	1	1	0	1	0	1	0	0
81 250 to 81 350	1	1	1	1	0	1	1	1	1	1	1	0	0
81 350 to 81 450	1	1	1	1	0	1	1	1	1	1	1	1	0
81 450 to 81 550	1	1	1	1	0	1	1	1	1	1	0	1	0
81 550 to 81 650	1	1	1	1	0	1	1	1	1	1	0	1	1
81 650 to 81 750	1	1	1	1	0	1	1	1	1	1	0	0	1
81 750 to 81 850	1	1	1	1	0	1	0	1	0	1	0	0	1
81 850 to 81 950	1	1	1	1	0	1	0	1	0	1	0	1	1
81 950 to 82 050	1	1	1	1	0	1	0	1	0	1	0	1	0
82 050 to 82 150	1	1	1	1	0	1	0	1	0	1	1	1	0
82 150 to 82 250	1	1	1	1	0	1	0	1	0	1	1	0	0
82 250 to 82 350	1	1	1	1	0	1	0	0	0	1	0	0	0
82 350 to 82 450	1	1	1	1	0	1	0	0	0	1	1	1	0
82 450 to 82 550	1	1	1	1	0	1	0	0	0	0	1	0	0
82 550 to 82 650	1	1	1	1	0	1	0	0	0	0	1	1	1
82 650 to 82 750	1	1	1	1	0	1	0	0	0	0	0	0	1
82 750 to 82 850	1	1	1	1	1	1	0	0	0	0	0	0	1
82 850 to 82 950	1	1	1	1	1	1	0	0	0	0	1	1	1
82 950 to 83 050	1	1	1	1	1	1	0	0	0	0	1	0	0
83 050 to 83 150	1	1	1	1	1	1	0	0	0	1	1	1	0
83 150 to 83 250	1	1	1	1	1	1	0	0	0	1	0	0	0
83 250 to 83 350	1	1	1	1	1	1	0	1	1	1	0	0	0
83 350 to 83 450	1	1	1	1	1	1	0	1	1	1	1	1	0
83 450 to 83 550	1	1	1	1	1	1	0	1	1	0	1	0	0
83 550 to 83 650	1	1	1	1	1	1	0	1	1	0	1	1	1
83 650 to 83 750	1	1	1	1	1	1	0	1	1	0	0	0	1

RANGE	PULSE POSITIONS (0 or 1 in a pulse position denotes absence or presence of a pulse, respectively)												
	Increments (Feet)			D ₂	D ₄	A ₁	A ₂	A ₄	B ₁	B ₂	B ₄	C ₁	C ₂
83 750 to 83 850	1	1	1	1	1	1	1	1	1	1	0	0	1
83 850 to 83 950	1	1	1	1	1	1	1	1	1	1	0	1	1
83 950 to 84 050	1	1	1	1	1	1	1	1	1	1	0	1	0
84 050 to 84 150	1	1	1	1	1	1	1	1	1	1	1	1	0
84 150 to 84 250	1	1	1	1	1	1	1	1	1	1	1	0	0
84 250 to 84 350	1	1	1	1	1	1	1	1	1	0	1	0	0
84 350 to 84 450	1	1	1	1	1	1	1	1	1	0	1	1	0
84 450 to 84 550	1	1	1	1	1	1	1	1	1	0	0	1	0
84 550 to 84 650	1	1	1	1	1	1	1	1	1	0	0	1	1
84 650 to 84 750	1	1	1	1	1	1	1	1	1	0	0	0	1
84 750 to 84 850	1	1	1	1	1	1	0	1	0	0	0	0	1
84 850 to 84 950	1	1	1	1	1	1	0	1	0	0	0	1	1
84 950 to 85 050	1	1	1	1	1	1	0	1	0	0	0	1	0
85 050 to 85 150	1	1	1	1	1	1	0	1	0	0	1	1	0
85 150 to 85 250	1	1	1	1	1	1	0	1	0	0	1	0	0
85 250 to 85 350	1	1	1	1	1	1	0	1	1	1	1	0	0
85 350 to 85 450	1	1	1	1	1	1	0	1	1	1	1	1	0
85 450 to 85 550	1	1	1	1	1	1	0	1	1	1	0	1	0
85 550 to 85 650	1	1	1	1	1	1	0	1	1	1	0	1	1
85 650 to 85 750	1	1	1	1	1	1	0	1	1	1	0	0	1
85 750 to 85 850	1	1	1	1	1	1	0	0	1	0	0	0	1
85 850 to 85 950	1	1	1	1	1	1	0	0	1	0	0	1	1
85 950 to 86 050	1	1	1	1	1	1	0	0	1	0	0	1	0
86 050 to 86 150	1	1	1	1	1	1	0	0	1	0	0	1	0
86 150 to 86 250	1	1	1	1	1	1	0	0	1	0	0	1	0
86 250 to 86 350	1	1	1	1	1	1	0	0	0	0	1	0	0
86 350 to 86 450	1	1	1	1	1	1	0	0	0	0	1	1	0
86 450 to 86 550	1	1	1	1	1	1	0	0	0	0	0	1	0
86 550 to 86 650	1	1	1	1	1	1	0	0	0	0	0	1	1
86 650 to 86 750	1	1	1	1	1	1	0	0	0	0	0	0	1
86 750 to 86 850	1	1	1	0	1	0	0	0	0	0	0	0	1
86 850 to 86 950	1	1	1	0	1	0	0	0	0	0	0	1	1
86 950 to 87 050	1	1	1	0	1	0	0	0	0	0	0	1	0
87 050 to 87 150	1	1	1	0	1	0	0	0	0	0	1	1	0
87 150 to 87 250	1	1	1	0	1	0	0	0	0	0	1	0	0
87 250 to 87 350	1	1	1	0	1	0	0	1	0	0	1	0	0
87 350 to 87 450	1	1	1	0	1	0	0	1	0	0	1	1	0
87 450 to 87 550	1	1	1	0	1	0	0	1	0	0	0	1	0
87 550 to 87 650	1	1	1	0	1	0	0	1	0	0	0	1	1
87 650 to 87 750	1	1	1	0	1	0	0	1	0	0	0	0	1
87 750 to 87 850	1	1	1	0	1	0	1	1	0	0	0	0	1
87 850 to 87 950	1	1	1	0	1	0	1	1	0	1	0	1	1
87 950 to 88 050	1	1	1	0	1	0	1	1	0	1	0	1	0
88 050 to 88 150	1	1	1	0	1	0	1	1	0	1	1	1	0
88 150 to 88 250	1	1	1	0	1	0	1	1	0	1	1	0	0

RANGE	PULSE POSITIONS (0 or 1 in a pulse position denotes absence or presence of a pulse, respectively)												
	Increments (Feet)			D ₂	D ₄	A ₁	A ₂	A ₄	B ₁	B ₂	B ₄	C ₁	C ₂
88 250 to 88 350	1	1	1	0	1	0	1	0	1	0	1	0	0
88 350 to 88 450	1	1	1	0	1	0	1	0	1	0	1	1	0
88 450 to 88 550	1	1	1	0	1	0	1	0	1	0	0	1	0
88 550 to 88 650	1	1	1	0	1	0	1	0	1	0	0	1	1
88 650 to 88 750	1	1	1	0	1	0	1	0	1	0	0	0	1
88 750 to 88 850	1	1	1	0	1	1	1	1	0	0	0	0	1
88 850 to 88 950	1	1	1	0	1	1	1	1	0	0	0	1	1
88 950 to 89 050	1	1	1	0	1	1	1	1	0	0	0	1	0
89 050 to 89 150	1	1	1	0	1	1	1	1	0	1	1	1	0
89 150 to 89 250	1	1	1	0	1	1	1	1	0	1	1	0	0
89 250 to 89 350	1	1	1	0	1	1	1	1	1	1	1	0	0
89 350 to 89 450	1	1	1	0	1	1	1	1	1	1	1	1	0
89 450 to 89 550	1	1	1	0	1	1	1	1	1	0	1	1	0
89 550 to 89 650	1	1	1	0	1	1	1	1	1	0	0	1	1
89 650 to 89 750	1	1	1	0	1	1	1	1	1	0	0	0	1
89 750 to 89 850	1	1	1	0	1	1	0	1	0	1	0	0	1
89 850 to 89 950	1	1	1	0	1	1	0	1	0	1	0	1	1
89 950 to 90 050	1	1	1	0	1	1	0	1	0	1	0	1	0
90 050 to 90 150	1	1	1	0	1	1	0	1	0	1	1	1	0
90 150 to 90 250	1	1	1	0	1	1	0	1	0	1	1	0	0
90 250 to 90 350	1	1	1	0	1	1	0	0	0	1	0	0	0
90 350 to 90 450	1	1	1	0	1	1	0	0	0	1	1	1	0
90 450 to 90 550	1	1	1	0	1	1	0	0	0	0	1	1	0
90 550 to 90 650	1	1	1	0	1	1	0	0	0	0	1	1	1
90 650 to 90 750	1	1	1	0	1	1	0	0	0	0	0	0	1
90 750 to 90 850	1	1	1	0	0	1	0	0	0	0	0	0	1
90 850 to 90 950	1	1	1	0	0	1	0	0	0	0	0	1	1
90 950 to 91 050	1	1	1	0	0	1	0	0	0	0	0	1	0
91 050 to 91 150	1	1	1	0	0	1	0	0	0	1	1	1	0
91 150 to 91 250	1	1	1	0	0	1	0	0	0	1	0	0	0
91 250 to 91 350	1	1	1	0	0	1	0	1	0	1	1	0	0
91 350 to 91 450	1	1	1	0	0	1	0	1	0	1	1	1	0
91 450 to 91 550	1	1	1	0	0	1	0	1	0	1	0	1	0
91 550 to 91 650	1	1	1	0	0	1	0	1	0	1	0	1	1
91 650 to 91 750	1	1	1	0	0	1	0	1	0	1	0	0	1
91 750 to 91 850	1	1	1	0	0	1	1	1	1	0	0	0	1
91 850 to 91 950	1	1	1	0	0	1	1	1	1	0	0	1	1
91 950 to 92 050	1	1	1	0	0	1	1	1	1	0	0	1	0
92 050 to 92 150	1	1	1	0	0	1	1	1	1	1	1	1	0
92 150 to 92 250	1	1	1	0	0	1	1	1	1	1	1	0	0
92 250 to 92 350	1	1	1	0	0	1	1	0	0	1	0	0	0
92 350 to 92 450	1	1	1	0	0	1	1	0	0	1	1	1	0
92 450 to 92 550	1	1	1	0	0	1	1	0	0	0	1	1	0
92 550 to 92 650	1	1	1	0	0	1	1	0	0	0	1	1	1
92 650 to 92 750	1	1	1	0	0	1	1	0	0	0	0	0	1

RANGE	PULSE POSITIONS (0 or 1 in a pulse position denotes absence or presence of a pulse, respectively)												
	Increments (Feet)			D ₂	D ₄	A ₁	A ₂	A ₄	B ₁	B ₂	B ₄	C ₁	C ₂
92 750 to 92 850	1	1	1	0	0	0	0	1	0	0	0	1	1
92 850 to 92 950	1	1	1	0	0	0	0	1	0	0	1	1	1
92 950 to 93 050	1	1	1	0	0	0	0	1	0	0	1	1	0
93 050 to 93 150	1	1	1	0	0	0	0	1	0	0	1	1	0
93 150 to 93 250	1	1	1	0	0	0	0	1	0	0	1	0	0
93 250 to 93 350	1	1	1	0	0	0	0	1	1	1	1	0	0
93 350 to 93 450	1	1	1	0	0	0	0	1	1	1	1	1	0
93 450 to 93 550	1	1	1	0	0	0	0	1	1	1	0	1	0
93 550 to 93 650	1	1	1	0	0	0	0	1	1	1	0	1	1
93 650 to 93 750	1	1	1	0	0	0	0	1	1	1	0	0	1
93 750 to 93 850	1	1	1	0	0	0	0	0	1	1	0	0	1
93 850 to 93 950	1	1	1	0	0	0	0	0	1	1	0	1	1
93 950 to 94 050	1	1	1	0	0	0	0	0	1	1	0	1	0
94 050 to 94 150	1	1	1	0	0	0	0	0	1	1	1	1	0
94 150 to 94 250	1	1	1	0	0	0	0	0	1	1	1	0	0
94 250 to 94 350	1	1	1	0	0	0	0	0	0	0	1	0	0
94 350 to 94 450	1	1	1	0	0	0	0	0	0	0	1	1	0
94 450 to 94 550	1	1	1	0	0	0	0	0	0	0	0	1	0
94 550 to 94 650	1	1	1	0	0	0	0	0	0	0	0	1	1
94 650 to 94 750	1	1	1	0	0	0	0	0	0	0	0	0	1
94 750 to 94 850	1	0	1	0	0	0	0	0	0	0	0	0	1
94 850 to 94 950	1	0	1	0	0	0	0	0	0	0	0	1	1
94 950 to 95 050	1	0	1	0	0	0	0	0	0	0	0	1	0
95 050 to 95 150	1	0	1	0	0	0	0	0	0	0	1	1	0
95 150 to 95 250	1	0	1	0	0	0	0	0	0	0	1	0	0
95 250 to 95 350	1	0	1	0	0	0	0	0	1	1	1	0	0
95 350 to 95 450	1	0	1	0	0	0	0	0	1	1	1	1	0
95 450 to 95 550	1	0	1	0	0	0	0	0	1	1	0	1	0
95 550 to 95 650	1	0	1	0	0	0	0	0	1	1	0	1	1
95 650 to 95 750	1	0	1	0	0	0	0	0	1	1	0	0	1
95 750 to 95 850	1	0	1	0	0	0	0	1	1	1	0	0	1
95 850 to 95 950	1	0	1	0	0	0	0	1	1	1	0	1	1
95 950 to 96 050	1	0	1	0	0	0	0	1	1	1	0	1	0
96 050 to 96 150	1	0	1	0	0	0	0	1	1	1	1	1	0
96 150 to 96 250	1	0	1	0	0	0	0	1	1	1	1	0	0
96 250 to 96 350	1	0	1	0	0	0	0	1	0	0	1	0	0
96 350 to 96 450	1	0	1	0	0	0	0	1	0	0	1	1	0
96 450 to 96 550	1	0	1	0	0	0	0	1	0	0	0	1	0
96 550 to 96 650	1	0	1	0	0	0	0	1	0	0	0	1	1
96 650 to 96 750	1	0	1	0	0	0	0	1	0	0	0	0	1
96 750 to 96 850	1	0	1	0	0	1	1	0	0	0	0	0	1
96 850 to 96 950	1	0	1	0	0	1	1	0	0	0	0	1	1
96 950 to 97 050	1	0	1	0	0	1	1	0	0	0	0	1	0
97 050 to 97 150	1	0	1	0	0	1	1	0	0	0	1	1	0
97 150 to 97 250	1	0	1	0	0	1	1	0	0	0	1	0	0

RANGE	PULSE POSITIONS (0 or 1 in a pulse position denotes absence or presence of a pulse, respectively)												
	Increments (Feet)			D ₂	D ₄	A ₁	A ₂	A ₄	B ₁	B ₂	B ₄	C ₁	C ₂
97 250 to 97 350	1	0	1	0	0	1	1	1	1	1	0	0	0
97 350 to 97 450	1	0	1	0	0	1	1	1	1	1	1	1	0
97 450 to 97 550	1	0	1	0	0	1	1	1	1	1	0	1	0
97 550 to 97 650	1	0	1	0	0	1	1	1	1	1	0	1	1
97 650 to 97 750	1	0	1	0	0	1	1	1	1	1	0	0	1
97 750 to 97 850	1	0	1	0	0	1	0	1	0	1	0	0	1
97 850 to 97 950	1	0	1	0	0	1	0	1	0	1	0	1	1
97 950 to 98 050	1	0	1	0	0	1	0	1	0	1	0	1	0
98 050 to 98 150	1	0	1	0	0	1	0	1	0	1	1	1	0
98 150 to 98 250	1	0	1	0	0	1	0	1	0	1	1	0	0
98 250 to 98 350	1	0	1	0	0	1	0	0	0	0	1	0	0
98 350 to 98 450	1	0	1	0	0	1	0	0	0	0	1	1	0
98 450 to 98 550	1	0	1	0	0	1	0	0	0	0	0	1	0
98 550 to 98 650	1	0	1	0	0	1	0	0	0	0	0	1	1
98 650 to 98 750	1	0	1	0	0	1	0	0	0	0	0	0	1
98 750 to 98 850	1	0	1	0	1	1	1	0	0	0	0	0	1
98 850 to 98 950	1	0	1	0	1	1	1	0	0	0	0	1	1
98 950 to 99 050	1	0	1	0	1	1	1	0	0	0	0	1	0
99 050 to 99 150	1	0	1	0	1	1	1	0	0	0	1	1	0
99 150 to 99 250	1	0	1	0	1	1	1	0	0	0	1	0	0
99 250 to 99 350	1	0	1	0	1	1	0	1	0	1	1	0	0
99 350 to 99 450	1	0	1	0	1	1	1	0	1	1	1	1	0
99 450 to 99 550	1	0	1	0	1	1	1	0	1	1	0	1	0
99 550 to 99 650	1	0	1	0	1	1	1	0	1	1	0	1	1
99 650 to 99 750	1	0	1	0	1	1	1	0	1	1	0	0	1
99 750 to 99 850	1	0	1	0	1	1	1	1	1	1	0	0	1
99 850 to 99 950	1	0	1	0	1	1	1	1	1	1	0	1	1
99 950 to 100 050	1	0	1	0	1	1	1	1	1	1	0	1	0
100 050 to 100 150	1	0	1	0	1	1	1	1	1	1	1	1	0
100 150 to 100 250	1	0	1	0	1	1	1	1	1	1	1	0	0
100 250 to 100 350	1	0	1	0	1	1	1	1	0	0	1	0	0
100 350 to 100 450	1	0	1	0	1	1	1	1	0	0	1	1	0
100 450 to 100 550	1	0	1	0	1	1	1	1	0	0	0	1	0
100 550 to 100 650	1	0	1	0	1	1	1	1	0	0	0	1	1
100 650 to 100 750	1	0	1	0	1	1	1	1	0	0	0	0	1
100 750 to 100 850	1	0	1	0	1	0	1	0	0	0	0	0	1
100 850 to 100 950	1	0	1	0	1	0	1	0	0	0	0	1	1
100 950 to 101 050	1	0	1	0	1	0	1	0	0	0	0	1	0
101 050 to 101 150	1	0	1	0	1	0	1	0	0	1	1	1	0
101 150 to 101 250	1	0	1	0	1	0	1	0	0	1	1	0	0
101 250 to 101 350	1	0	1	0	1	0	1	1	1	1	1	0	0
101 350 to 101 450	1	0	1	0	1	0	1	0	1	1	1	1	0
101 450 to 101 550	1	0	1	0	1	0	1	0	1	1	0	1	0
101 550 to 101 650	1	0	1	0	1	0	1	0	1	1	0	1	1
101 650 to 101 750	1	0	1	0	1	0	1	0	1	1	0	0	1

RANGE	PULSE POSITIONS (0 or 1 in a pulse position denotes absence or presence of a pulse, respectively)													
	Increments (Feet)			D ₂	D ₄	A ₁	A ₂	A ₄	B ₁	B ₂	B ₄	C ₁	C ₂	C ₄
101 750 to 101 850	1	0	1	0	1	0	0	1	0	0	1	0	0	1
101 850 to 101 950	1	0	1	0	1	0	0	1	0	0	1	0	1	1
101 950 to 102 050	1	0	1	0	1	0	0	1	0	0	1	0	1	0
102 050 to 102 150	1	0	1	0	1	0	0	1	0	0	1	1	1	0
102 150 to 102 250	1	0	1	0	1	0	0	1	0	0	1	1	0	0
102 250 to 102 350	1	0	1	0	1	0	0	0	0	0	1	0	0	0
102 350 to 102 450	1	0	1	0	1	0	0	0	0	0	1	1	1	0
102 450 to 102 550	1	0	1	0	1	0	0	0	0	0	0	0	1	0
102 550 to 102 650	1	0	1	0	1	0	0	0	0	0	0	0	1	1
102 650 to 102 750	1	0	1	0	1	0	0	0	0	0	0	0	0	1
102 750 to 102 850	1	0	1	1	1	1	0	0	0	0	0	0	0	1
102 850 to 102 950	1	0	1	1	1	1	0	0	0	0	0	0	1	1
102 950 to 103 050	1	0	1	1	1	1	0	0	0	0	0	0	1	0
103 050 to 103 150	1	0	1	1	1	1	0	0	0	0	1	1	1	0
103 150 to 103 250	1	0	1	1	1	1	0	0	0	0	1	0	0	0
103 250 to 103 350	1	0	1	1	1	1	0	0	1	1	1	0	0	0
103 350 to 103 450	1	0	1	1	1	1	0	0	1	1	1	1	1	0
103 450 to 103 550	1	0	1	1	1	1	0	0	1	1	0	0	1	0
103 550 to 103 650	1	0	1	1	1	1	0	0	1	1	0	0	1	1
103 650 to 103 750	1	0	1	1	1	1	0	0	1	1	0	0	0	1
103 750 to 103 850	1	0	1	1	1	1	0	1	1	1	0	0	0	1
103 850 to 103 950	1	0	1	1	1	1	0	1	1	1	0	0	1	1
103 950 to 104 050	1	0	1	1	1	1	0	1	1	1	0	0	1	0
104 050 to 104 150	1	0	1	1	1	1	0	1	1	1	1	1	1	0
104 150 to 104 250	1	0	1	1	1	1	0	1	1	1	1	1	0	0
104 250 to 104 350	1	0	1	1	1	1	0	1	0	0	1	0	0	0
104 350 to 104 450	1	0	1	1	1	1	0	1	0	0	1	1	1	0
104 450 to 104 550	1	0	1	1	1	1	0	1	0	0	0	0	1	0
104 550 to 104 650	1	0	1	1	1	1	0	1	0	0	0	0	1	1
104 650 to 104 750	1	0	1	1	1	1	0	1	0	0	0	0	0	1
104 750 to 104 850	1	0	1	1	1	1	1	1	0	0	0	0	0	1
104 850 to 104 950	1	0	1	1	1	1	1	1	0	0	0	0	1	1
104 950 to 105 050	1	0	1	1	1	1	1	1	0	0	0	0	1	0
105 050 to 105 150	1	0	1	1	1	1	1	1	0	1	1	1	1	0
105 150 to 105 250	1	0	1	1	1	1	1	1	0	1	1	0	0	0
105 250 to 105 350	1	0	1	1	1	1	1	1	1	1	1	1	0	0
105 350 to 105 450	1	0	1	1	1	1	1	1	1	1	1	1	1	0
105 450 to 105 550	1	0	1	1	1	1	1	1	1	1	0	0	1	0
105 550 to 105 650	1	0	1	1	1	1	1	1	1	1	0	0	1	1
105 650 to 105 750	1	0	1	1	1	1	1	1	1	1	0	0	0	1
105 750 to 105 850	1	0	1	1	1	1	1	0	1	0	0	0	0	1
105 850 to 105 950	1	0	1	1	1	1	1	0	1	0	0	0	1	1
105 950 to 106 050	1	0	1	1	1	1	1	0	1	0	0	0	1	0
106 050 to 106 150	1	0	1	1	1	1	1	0	1	0	1	1	1	0
106 150 to 106 250	1	0	1	1	1	1	1	0	1	0	1	1	0	0

RANGE	PULSE POSITIONS (0 or 1 in a pulse position denotes absence or presence of a pulse, respectively)												
	Increments (Feet)			D ₂	D ₄	A ₁	A ₂	A ₄	B ₁	B ₂	B ₄	C ₁	C ₂
106 250 to 106 350	1	0	1	1	1	1	1	0	0	1	0	0	
106 350 to 106 450	1	0	1	1	1	1	1	0	0	1	1	0	
106 450 to 106 550	1	0	1	1	1	1	1	0	0	0	1	0	
106 550 to 106 650	1	0	1	1	1	1	1	0	0	0	1	1	
106 650 to 106 750	1	0	1	1	1	1	1	0	0	0	0	1	
106 750 to 106 850	1	0	1	1	0	1	0	0	0	0	0	1	
106 850 to 106 950	1	0	1	1	0	1	0	0	0	0	1	1	
106 950 to 107 050	1	0	1	1	0	1	0	0	0	0	1	0	
107 050 to 107 150	1	0	1	1	0	1	0	0	0	1	1	0	
107 150 to 107 250	1	0	1	1	0	1	0	0	0	1	0	0	
107 250 to 107 350	1	0	1	1	0	1	0	1	0	1	0	0	
107 350 to 107 450	1	0	1	1	0	1	0	1	0	1	1	0	
107 450 to 107 550	1	0	1	1	0	1	0	1	0	1	0	0	
107 550 to 107 650	1	0	1	1	0	1	0	1	0	1	1	1	
107 650 to 107 750	1	0	1	1	0	1	0	1	0	1	0	1	
107 750 to 107 850	1	0	1	1	0	1	1	1	1	0	0	1	
107 850 to 107 950	1	0	1	1	0	1	1	1	1	0	1	1	
107 950 to 108 050	1	0	1	1	0	1	1	1	1	0	1	0	
108 050 to 108 150	1	0	1	1	0	1	1	1	1	1	1	0	
108 150 to 108 250	1	0	1	1	0	1	1	1	1	1	0	0	
108 250 to 108 350	1	0	1	1	0	1	1	0	0	1	0	0	
108 350 to 108 450	1	0	1	1	0	1	1	0	0	1	1	0	
108 450 to 108 550	1	0	1	1	0	1	1	0	0	0	1	0	
108 550 to 108 650	1	0	1	1	0	1	1	0	0	0	1	1	
108 650 to 108 750	1	0	1	1	0	1	1	0	0	0	0	1	
108 750 to 108 850	1	0	1	1	0	0	1	0	0	0	0	1	
108 850 to 108 950	1	0	1	1	0	0	1	0	0	0	1	1	
108 950 to 109 050	1	0	1	1	0	0	1	0	0	0	1	0	
109 050 to 109 150	1	0	1	1	0	0	1	0	0	1	1	0	
109 150 to 109 250	1	0	1	1	0	0	1	0	0	1	0	0	
109 250 to 109 350	1	0	1	1	0	0	1	1	1	1	0	0	
109 350 to 109 450	1	0	1	1	0	0	1	1	1	1	1	0	
109 450 to 109 550	1	0	1	1	0	0	1	1	1	0	1	0	
109 550 to 109 650	1	0	1	1	0	0	1	1	1	0	1	1	
109 650 to 109 750	1	0	1	1	0	0	1	1	1	0	0	1	
109 750 to 109 850	1	0	1	1	0	0	0	0	1	0	0	1	
109 850 to 109 950	1	0	1	1	0	0	0	0	1	0	1	1	
109 950 to 110 050	1	0	1	1	0	0	0	0	1	0	1	0	
110 050 to 110 150	1	0	1	1	0	0	0	0	1	1	1	0	
110 150 to 110 250	1	0	1	1	0	0	0	0	1	1	0	0	
110 250 to 110 350	1	0	1	1	0	0	0	0	0	1	0	0	
110 350 to 110 450	1	0	1	1	0	0	0	0	0	1	1	0	
110 450 to 110 550	1	0	1	1	0	0	0	0	0	0	1	0	
110 550 to 110 650	1	0	1	1	0	0	0	0	0	0	1	1	
110 650 to 110 750	1	0	1	1	0	0	0	0	0	0	0	1	

RANGE	PULSE POSITIONS (0 or 1 in a pulse position denotes absence or presence of a pulse, respectively)													
	Increments (Feet)			D ₂	D ₄	A ₁	A ₂	A ₄	B ₁	B ₂	B ₄	C ₁	C ₂	C ₄
110 750 to 110 850	1	0	0	1	0	0	0	0	0	0	0	0	0	1
110 850 to 110 950	1	0	0	1	0	0	0	0	0	0	0	0	1	1
110 950 to 111 050	1	0	0	1	0	0	0	0	0	0	0	0	1	0
111 050 to 111 150	1	0	0	1	0	0	0	0	0	0	0	1	1	0
111 150 to 111 250	1	0	0	1	0	0	0	0	0	0	0	1	0	0
111 250 to 111 350	1	0	0	1	0	0	0	0	0	1	1	0	0	0
111 350 to 111 450	1	0	0	1	0	0	0	0	0	1	1	1	1	0
111 450 to 111 550	1	0	0	1	0	0	0	0	0	1	0	1	0	0
111 550 to 111 650	1	0	0	1	0	0	0	0	0	1	0	1	1	1
111 650 to 111 750	1	0	0	1	0	0	0	0	0	1	0	0	0	1
111 750 to 111 850	1	0	0	1	0	0	0	1	1	1	0	0	0	1
111 850 to 111 950	1	0	0	1	0	0	0	1	1	1	0	0	1	1
111 950 to 112 050	1	0	0	1	0	0	0	1	1	1	0	0	1	0
112 050 to 112 150	1	0	0	1	0	0	0	1	1	1	1	1	1	0
112 150 to 112 250	1	0	0	1	0	0	0	1	1	1	1	0	0	0
112 250 to 112 350	1	0	0	1	0	0	0	1	0	0	1	0	0	0
112 350 to 112 450	1	0	0	1	0	0	0	1	0	0	1	1	1	0
112 450 to 112 550	1	0	0	1	0	0	0	1	0	0	0	1	0	0
112 550 to 112 650	1	0	0	1	0	0	0	1	0	0	0	1	1	1
112 650 to 112 750	1	0	0	1	0	0	0	1	0	0	0	0	0	1
112 750 to 112 850	1	0	0	1	0	1	1	1	0	0	0	0	0	1
112 850 to 112 950	1	0	0	1	0	1	1	1	0	0	0	0	1	1
112 950 to 113 050	1	0	0	1	0	1	1	1	0	0	0	0	1	0
113 050 to 113 150	1	0	0	1	0	1	1	1	0	0	1	1	1	0
113 150 to 113 250	1	0	0	1	0	1	1	1	0	0	1	0	0	0
113 250 to 113 350	1	0	0	1	0	1	1	1	1	1	1	0	0	0
113 350 to 113 450	1	0	0	1	0	1	1	1	1	1	1	1	1	0
113 450 to 113 550	1	0	0	1	0	1	1	1	1	1	0	1	0	0
113 550 to 113 650	1	0	0	1	0	1	1	1	1	1	0	1	1	1
113 650 to 113 750	1	0	0	1	0	1	1	1	1	1	0	0	0	1
113 750 to 113 850	1	0	0	1	0	1	0	1	0	1	0	0	0	1
113 850 to 113 950	1	0	0	1	0	1	0	1	0	1	0	0	1	1
113 950 to 114 050	1	0	0	1	0	1	0	1	0	1	0	0	1	0
114 050 to 114 150	1	0	0	1	0	1	0	1	0	1	1	1	1	0
114 150 to 114 250	1	0	0	1	0	1	0	1	0	1	1	0	0	0
114 250 to 114 350	1	0	0	1	0	1	0	0	0	0	1	0	0	0
114 350 to 114 450	1	0	0	1	0	1	0	0	0	0	1	1	1	0
114 450 to 114 550	1	0	0	1	0	1	0	0	0	0	0	1	0	0
114 550 to 114 650	1	0	0	1	0	1	0	0	0	0	0	1	1	1
114 650 to 114 750	1	0	0	1	0	1	0	0	0	0	0	0	0	1
114 750 to 114 850	1	0	0	1	1	1	1	0	0	0	0	0	0	1
114 850 to 114 950	1	0	0	1	1	1	1	0	0	0	0	0	1	1
114 950 to 115 050	1	0	0	1	1	1	1	0	0	0	0	0	1	0
115 050 to 115 150	1	0	0	1	1	1	1	0	0	0	1	1	1	0
115 150 to 115 250	1	0	0	1	1	1	1	0	0	0	1	0	0	0

RANGE	PULSE POSITIONS (0 or 1 in a pulse position denotes absence or presence of a pulse, respectively)													
	Increments (Feet)			D ₂	D ₄	A ₁	A ₂	A ₄	B ₁	B ₂	B ₄	C ₁	C ₂	C ₄
115 250 to 115 350	1	0	0	1	1	1	0	1	1	0	1	1	0	0
115 350 to 115 450	1	0	0	1	1	1	0	1	1	0	1	1	1	0
115 450 to 115 550	1	0	0	1	1	1	0	1	1	0	1	0	1	0
115 550 to 115 650	1	0	0	1	1	1	0	1	1	0	1	0	1	1
115 650 to 115 750	1	0	0	1	1	1	0	1	1	0	1	0	0	1
115 750 to 115 850	1	0	0	1	1	1	1	1	1	1	1	0	0	1
115 850 to 115 950	1	0	0	1	1	1	1	1	1	1	1	0	1	1
115 950 to 116 050	1	0	0	1	1	1	1	1	1	1	1	0	1	0
116 050 to 116 150	1	0	0	1	1	1	1	1	1	1	1	1	1	0
116 150 to 116 250	1	0	0	1	1	1	1	1	1	1	1	1	0	0
116 250 to 116 350	1	0	0	1	1	1	1	1	0	1	0	1	0	0
116 350 to 116 450	1	0	0	1	1	1	1	1	0	1	0	1	1	0
116 450 to 116 550	1	0	0	1	1	1	1	1	0	1	0	0	1	0
116 550 to 116 650	1	0	0	1	1	1	1	1	0	1	0	0	1	1
116 650 to 116 750	1	0	0	1	1	1	1	1	0	1	0	0	0	1
116 750 to 116 850	1	0	0	1	1	0	1	0	1	0	0	0	0	1
116 850 to 116 950	1	0	0	1	1	0	1	0	1	0	0	0	1	1
116 950 to 117 050	1	0	0	1	1	0	1	0	1	0	0	0	1	0
117 050 to 117 150	1	0	0	1	1	0	1	0	1	0	0	1	1	0
117 150 to 117 250	1	0	0	1	1	0	1	0	1	0	0	1	0	0
117 250 to 117 350	1	0	0	1	1	0	1	1	1	1	1	1	0	0
117 350 to 117 450	1	0	0	1	1	0	1	1	1	1	1	1	1	0
117 450 to 117 550	1	0	0	1	1	0	1	1	1	1	1	0	1	0
117 550 to 117 650	1	0	0	1	1	0	1	1	1	1	1	0	1	1
117 650 to 117 750	1	0	0	1	1	0	1	1	1	1	1	0	0	1
117 750 to 117 850	1	0	0	1	1	0	0	0	1	0	0	0	0	1
117 850 to 117 950	1	0	0	1	1	0	0	0	1	0	0	0	1	1
117 950 to 118 050	1	0	0	1	1	0	0	0	1	0	0	0	1	0
118 050 to 118 150	1	0	0	1	1	0	0	0	1	0	0	1	1	0
118 150 to 118 250	1	0	0	1	1	0	0	0	1	0	0	1	0	0
118 250 to 118 350	1	0	0	1	1	0	0	0	0	0	0	1	0	0
118 350 to 118 450	1	0	0	1	1	0	0	0	0	0	0	1	1	0
118 450 to 118 550	1	0	0	1	1	0	0	0	0	0	0	0	1	0
118 550 to 118 650	1	0	0	1	1	0	0	0	0	0	0	0	1	1
118 650 to 118 750	1	0	0	1	1	0	0	0	0	0	0	0	0	1
118 750 to 118 850	1	0	0	0	1	0	0	0	0	0	0	0	0	1
118 850 to 118 950	1	0	0	0	1	0	0	0	0	0	0	0	1	1
118 950 to 119 050	1	0	0	0	1	0	0	0	0	0	0	0	1	0
119 050 to 119 150	1	0	0	0	1	0	0	0	0	0	0	1	1	0
119 150 to 119 250	1	0	0	0	1	0	0	0	0	0	0	1	0	0
119 250 to 119 350	1	0	0	0	1	0	0	1	0	0	1	1	0	0
119 350 to 119 450	1	0	0	0	1	0	0	1	0	0	1	1	1	0
119 450 to 119 550	1	0	0	0	1	0	0	1	0	0	1	0	1	0
119 550 to 119 650	1	0	0	0	1	0	0	1	0	0	1	0	1	1
119 650 to 119 750	1	0	0	0	1	0	0	1	0	0	1	0	0	1

RANGE	PULSE POSITIONS (0 or 1 in a pulse position denotes absence or presence of a pulse, respectively)													
	Increments (Feet)			D ₂	D ₄	A ₁	A ₂	A ₄	B ₁	B ₂	B ₄	C ₁	C ₂	C ₄
119 750 to 119 850	1	0	0	0	1	0	1	1	0	0	1	0	0	1
119 850 to 119 950	1	0	0	0	1	0	1	1	0	1	1	0	1	1
119 950 to 120 050	1	0	0	0	1	0	1	1	0	1	1	0	1	0
120 050 to 120 150	1	0	0	0	1	0	1	1	0	1	1	1	1	0
120 150 to 120 250	1	0	0	0	1	0	1	1	0	1	1	1	0	0
120 250 to 120 350	1	0	0	0	1	0	1	0	1	0	1	1	0	0
120 350 to 120 450	1	0	0	0	1	0	1	0	1	0	1	1	1	0
120 450 to 120 550	1	0	0	0	1	0	1	0	1	0	1	0	1	0
120 550 to 120 650	1	0	0	0	1	0	1	0	1	0	1	0	1	1
120 650 to 120 750	1	0	0	0	1	0	1	0	1	0	1	0	0	1
120 750 to 120 850	1	0	0	0	1	1	1	1	0	1	0	0	0	1
120 850 to 120 950	1	0	0	0	1	1	1	1	0	1	0	0	1	1
120 950 to 121 050	1	0	0	0	1	1	1	1	0	1	0	0	1	0
121 050 to 121 150	1	0	0	0	1	1	1	1	0	1	0	1	1	0
121 150 to 121 250	1	0	0	0	1	1	1	1	0	1	0	1	0	0
121 250 to 121 350	1	0	0	0	1	1	1	1	1	1	1	1	0	0
121 350 to 121 450	1	0	0	0	1	1	1	1	1	1	1	1	1	0
121 450 to 121 550	1	0	0	0	1	1	1	1	1	1	1	0	1	0
121 550 to 121 650	1	0	0	0	1	1	1	1	1	1	1	0	1	1
121 650 to 121 750	1	0	0	0	1	1	1	1	1	1	1	0	0	1
121 750 to 121 850	1	0	0	0	1	1	0	1	1	0	1	0	0	1
121 850 to 121 950	1	0	0	0	1	1	0	1	1	0	1	0	1	1
121 950 to 122 050	1	0	0	0	1	1	0	1	1	0	1	0	1	0
122 050 to 122 150	1	0	0	0	1	1	0	1	1	0	1	1	1	0
122 150 to 122 250	1	0	0	0	1	1	0	1	1	0	1	1	0	0
122 250 to 122 350	1	0	0	0	1	1	0	0	1	0	0	1	0	0
122 350 to 122 450	1	0	0	0	1	1	0	0	1	0	0	1	1	0
122 450 to 122 550	1	0	0	0	1	1	0	0	1	0	0	0	1	0
122 550 to 122 650	1	0	0	0	1	1	0	0	1	0	0	0	1	1
122 650 to 122 750	1	0	0	0	1	1	0	0	1	0	0	0	0	1
122 750 to 122 850	1	0	0	0	0	1	0	0	1	0	0	0	0	1
122 850 to 122 950	1	0	0	0	0	1	0	0	1	0	0	0	1	1
122 950 to 123 050	1	0	0	0	0	1	0	0	1	0	0	0	1	0
123 050 to 123 150	1	0	0	0	0	1	0	0	1	0	0	1	1	0
123 150 to 123 250	1	0	0	0	0	1	0	0	1	0	0	1	0	0
123 250 to 123 350	1	0	0	0	0	1	0	1	1	0	1	1	0	0
123 350 to 123 450	1	0	0	0	0	1	0	1	1	0	1	1	1	0
123 450 to 123 550	1	0	0	0	0	1	0	1	1	0	1	0	1	0
123 550 to 123 650	1	0	0	0	0	1	0	1	1	0	1	0	1	1
123 650 to 123 750	1	0	0	0	0	1	0	1	1	0	1	0	0	1
123 750 to 123 850	1	0	0	0	0	1	1	1	1	0	0	0	0	1
123 850 to 123 950	1	0	0	0	0	1	1	1	1	0	0	0	1	1
123 950 to 124 050	1	0	0	0	0	1	1	1	1	0	0	0	1	0
124 050 to 124 150	1	0	0	0	0	1	1	1	1	1	1	1	1	0
124 150 to 124 250	1	0	0	0	0	1	1	1	1	1	1	1	0	0

RANGE	PULSE POSITIONS (0 or 1 in a pulse position denotes absence or presence of a pulse, respectively)													
	Increments (Feet)			D ₂	D ₄	A ₁	A ₂	A ₄	B ₁	B ₂	B ₄	C ₁	C ₂	C ₄
124 250	to	124 350	1	0	0	0	0	0	1	1	0	1	0	0
124 350	to	124 450	1	0	0	0	0	0	1	1	0	1	1	0
124 450	to	124 550	1	0	0	0	0	0	1	1	0	0	1	0
124 550	to	124 650	1	0	0	0	0	0	1	1	0	0	1	1
124 650	to	124 750	1	0	0	0	0	0	1	1	0	0	0	1
124 750	to	124 850	1	0	0	0	0	0	0	1	0	0	0	1
124 850	to	124 950	1	0	0	0	0	0	0	1	0	0	1	1
124 950	to	125 050	1	0	0	0	0	0	0	1	0	0	1	0
125 050	to	125 150	1	0	0	0	0	0	0	1	0	1	1	0
125 150	to	125 250	1	0	0	0	0	0	0	1	0	1	0	0
125 250	to	125 350	1	0	0	0	0	0	0	1	1	1	0	0
125 350	to	125 450	1	0	0	0	0	0	0	1	1	1	1	0
125 450	to	125 550	1	0	0	0	0	0	0	1	1	0	1	0
125 550	to	125 650	1	0	0	0	0	0	0	1	1	0	1	1
125 650	to	125 750	1	0	0	0	0	0	0	1	1	0	0	1
125 750	to	125 850	1	0	0	0	0	0	0	0	1	0	0	1
125 850	to	125 950	1	0	0	0	0	0	0	0	1	0	1	1
125 950	to	126 050	1	0	0	0	0	0	0	0	1	0	1	0
126 050	to	126 150	1	0	0	0	0	0	0	0	1	1	1	0
126 150	to	126 250	1	0	0	0	0	0	0	0	1	1	0	0
126 250	to	126 350	1	0	0	0	0	0	0	0	0	1	0	0
126 350	to	126 450	1	0	0	0	0	0	0	0	0	1	1	0
126 450	to	126 550	1	0	0	0	0	0	0	0	0	0	1	0
126 550	to	126 650	1	0	0	0	0	0	0	0	0	0	1	1
126 650	to	126 750	1	0	0	0	0	0	0	0	0	0	0	1

CHAPTER 4. AIRBORNE COLLISION AVOIDANCE SYSTEM

Introductory Note.— This chapter contains SARPs on ACAS I, ACAS II and ACAS III. The focus is especially on ACAS II, which provides vertical resolution advisories (RAs) in addition to traffic advisories (TAs). The related provisions are detailed in the following sections:

- 4.3 GENERAL PROVISIONS RELATING TO ACAS II AND ACAS III
- 4.4 PERFORMANCE OF THE ACAS II COLLISION AVOIDANCE LOGIC; and
- 4.5 ACAS USE OF EXTENDED SQUITTER

ACAS X and traffic alert and collision avoidance system (TCAS) Version 7.1 are considered as ACAS II systems. The provisions for ACAS X-compliant systems in this chapter cover ACAS Xa (a stands for “active surveillance”, which is its main surveillance source) and ACAS Xo (o stands for “operation specific”). ACAS Xa is developed for large commercial aircraft. ACAS Xo is a specific variation of ACAS X that adds special modes to ACAS Xa.

ACAS X is an alternative to, and interoperable with, TCAS Version 7.1-compliant systems. However, there are differences between ACAS X and TCAS Version 7.1, mainly in two areas: the collision avoidance logic and the sources of surveillance data. With these differences, technical requirements which are specific to either ACAS X or TCAS version 7.1 are identified within this Annex as “For ACAS X-compliant systems” or “For TCAS 7.1-compliant systems”.

Guidance material related to both ACAS X-compliant systems and TCAS 7.1-compliant systems including similarities and differences (e.g. monitoring and training) are contained in the Airborne Collision Avoidance System (ACAS) Manual (Doc 9863).

It is to be noted that hybrid and extended hybrid surveillance provisions contained in section 4.5 describe functionalities which are optional for TCAS version 7.1-compliant systems. However, their use is encouraged in order to minimize the risk of ACAS RF spectrum congestion, as proper and efficient utilization of available bandwidth and capacity at 1 030 MHz and 1 090 MHz is a key element to ensuring the safe operation of not only ACAS but also several surveillance systems such as secondary surveillance radar (SSR) and automatic dependent surveillance broadcast (ADS-B). These functionalities are included in ACAS X-compliant systems.

Non-SI alternative units are used as permitted by Annex 5, Chapter 3, 3.2.2. In limited cases, to ensure consistency at the level of the logic calculations, units such as ft/s, NM/s and kt/s are used.

For more details of TCAS Version 7.1-compliant systems, refer to the RTCA/DO-185B or EUROCAE/ED-143 specifications, i.e. equipment that incorporates the TCAS Version 7.1. For ACAS X-compliant systems, refer to the RTCA/DO-385 or EUROCAE/ED-256 specifications, i.e. equipment that incorporates the airborne collision avoidance system X (ACAS X). Equipment meeting the ACAS X or TCAS Version 7.1 specifications listed above are compliant with the ACAS II requirements listed in Chapter 4. Equipment meeting the RTCA/DO-185A specifications (also known as TCAS Version 7.0) are not compliant with the ACAS II requirements listed in Chapter 4.

4.1 DEFINITIONS RELATING TO AIRBORNE COLLISION AVOIDANCE SYSTEM

ACAS I. An ACAS which provides information as an aid to “see and avoid” action but does not include the capability for generating resolution advisories (RAs).

Note.— ACAS I is not intended for international implementation and standardization by ICAO. Therefore, only ACAS I characteristics required to ensure compatible operation with other ACAS configurations and interference limiting are defined in 4.2.

ACAS II. An ACAS which provides vertical resolution advisories (RAs) in addition to traffic advisories (TAs).

ACAS III. An ACAS which provides vertical and horizontal resolution advisories (RAs) in addition to traffic advisories (TAs).

ACAS broadcast. A long Mode S air-air surveillance interrogation (UF = 16) with the broadcast address.

Active RAC. An RAC is active if it currently constrains the selection of the RA. RACs that have been received within the last six seconds and have not been explicitly cancelled are active.

Altitude crossing RA. A resolution advisory is altitude crossing if own ACAS aircraft is currently at least 30 m (100 ft) below or above the threat aircraft for upward or downward sense advisories, respectively.

Climb RA. A positive RA recommending a climb but not an increased climb.

Closest approach. The occurrence of minimum range between own ACAS aircraft and the intruder. Thus range at closest approach is the smallest range between the two aircraft and time of closest approach is the time at which this occurs.

Coordination. The process by which two ACAS-equipped aircraft select compatible resolution advisories (RAs) by the exchange of resolution advisory complements (RACs).

Coordination interrogation. A Mode S interrogation (uplink transmission) radiated by ACAS II or III and containing a resolution message.

Coordination reply. A Mode S reply (downlink transmission) acknowledging the receipt of a coordination interrogation by the Mode S transponder that is part of an ACAS II or III installation.

Corrective RA. A resolution advisory that advises the pilot to deviate from the current flight path.

Cycle. The term “cycle” used in this chapter refers to one complete pass through the sequence of functions executed by ACAS II or ACAS III, nominally once a second.

Descend RA. A positive RA recommending a descent but not an increased descent.

Established track. A track generated by ACAS air-air surveillance that is treated as the track of an actual aircraft.

Increased rate RA. A resolution advisory with a strength that recommends increasing the altitude rate to a value exceeding that recommended by a previous climb or descend RA.

Intruder. An aircraft for which ACAS has an established track.

Own aircraft. The aircraft fitted with the ACAS that is the subject of the discourse, which ACAS is to protect against possible collisions, and which may enter a manoeuvre in response to an ACAS indication.

Positive RA. A resolution advisory that advises the pilot either to climb or to descend (applies to ACAS II).

Potential threat. An intruder deserving special attention either because of its close proximity to own aircraft or because successive range and altitude measurements indicate that it could be on a collision or near-collision course with own aircraft. The warning time provided against a potential threat is sufficiently small that a traffic advisory (TA) is justified but not so small that a resolution advisory (RA) would be justified.

Preventive RA. A resolution advisory that advises the pilot to avoid certain deviations from the current flight path but does not require any change in the current flight path.

RA sense. The sense of an ACAS II RA is “upward” if it requires climb or limitation of descent rate and “downward” if it requires descent or limitation of climb rate. It can be both upward and downward simultaneously if it requires limitation of the vertical rate to a specified range.

Note.— The RA sense may be both upward and downward when, having several simultaneous threats, ACAS generates an RA aimed at ensuring adequate separation below some threat(s) and above some other threat(s).

Resolution advisory (RA). An indication given to the flight crew recommending:

- a) a manoeuvre intended to provide separation from all threats; or
- b) a manoeuvre restriction intended to maintain existing separation.

Resolution advisory complement (RAC). Information provided by one ACAS to another via a Mode S interrogation in order to ensure complementary manoeuvres by restricting the choice of manoeuvres available to the ACAS receiving the RAC.

Resolution advisory complements record (RAC record). A composite of all currently active vertical RACs (VRCs) and horizontal RACs (HRCs) that have been received by ACAS. This information is provided by one ACAS to another ACAS or to a Mode S ground station via a Mode S reply.

Resolution advisory strength. The magnitude of the manoeuvre indicated by the RA. An RA may take on several successive strengths before being cancelled. Once a new RA strength is issued, the previous one automatically becomes void.

Resolution message. The message containing the resolution advisory complement (RAC).

Reversed sense RA. A resolution advisory that has had its sense reversed.

Sensitivity level (S). An integer defining a set of parameters used by the traffic advisory (TA) and collision avoidance algorithms to control the warning time provided by the potential threat and threat detection logic, as well as the values of parameters relevant to the RA selection logic.

Note.— For TA and RA selection, sensitivity level is not used in ACAS X-compliant systems.

Threat. An intruder deserving special attention either because of its close proximity to own aircraft or because successive range and altitude measurements indicate that it could be on a collision or near-collision course with own aircraft. The warning time provided against a threat is sufficiently small that an RA is justified.

Track. A sequence of measurements representing positions that could reasonably have been occupied by an aircraft.

Traffic advisory (TA). An indication given to the flight crew that a certain intruder is a potential threat.

Vertical speed limit (VSL) RA. A resolution advisory advising the pilot to avoid a given range of altitude rates. A VSL RA can be either corrective or preventive.

Warning time. The time interval between potential threat or threat detection and closest approach when neither aircraft accelerates.

4.2 ACAS I GENERAL PROVISIONS AND CHARACTERISTICS

4.2.1 *Functional requirements.* ACAS I shall perform the following functions:

- a) surveillance of nearby SSR transponder-equipped aircraft; and
- b) provide indications to the flight crew identifying the approximate position of nearby aircraft as an aid to visual acquisition.

Note.— ACAS I is intended to operate using Mode A/C interrogations only. Furthermore, it does not coordinate with other ACAS. Therefore, a Mode S transponder is not required as a part of an ACAS I installation.

4.2.2 *Signal format.* The RF characteristics of all ACAS I signals shall conform to the provisions of Chapter 3, 3.1.1.1 through 3.1.1.6 and 3.1.2.1 through 3.1.2.4.

4.2.3 Interference control

4.2.3.1 *Maximum radiated RF power.* The effective radiated power of an ACAS I transmission at 0 degree elevation relative to the longitudinal axis of the aircraft shall not exceed 24 dBW.

4.2.3.2 *Unwanted radiated power.* When ACAS I is not transmitting an interrogation, the effective radiated power in any direction shall not exceed -70 dBm.

Note.— This requirement is to ensure that, when not transmitting an interrogation, ACAS I does not radiate RF energy that could interfere with, or reduce the sensitivity of, the SSR transponder or radio equipment in other nearby aircraft or ground facilities.

4.2.3.3 *Interference limiting.* Each ACAS I interrogator shall control its interrogation rate or power or both in all SSR modes to minimize interference effects (4.2.3.3.3 and 4.2.3.3.4).

Note.— These limits are a means of ensuring that all interference effects resulting from these interrogations, together with the interrogations from all other ACAS I, ACAS II and ACAS III interrogators in the vicinity are kept to a low level.

4.2.3.3.1 *Determination of own transponder reply rate.* ACAS I shall monitor the rate that own transponder replies to interrogations to ensure that the provisions in 4.2.3.3.3 are met.

4.2.3.3.2 *Determination of the number of ACAS II and ACAS III interrogators.* ACAS I shall count the number of ACAS II and ACAS III interrogators in the vicinity to ensure that the provisions in 4.2.3.3.3 or 4.2.3.3.4 are met. This count shall be obtained by monitoring ACAS broadcasts (UF = 16), (4.3.7.1.2.4) and shall be updated as the number of distinct ACAS aircraft addresses received within the previous 20-s period at a nominal frequency of at least 1 Hz.

4.2.3.3.3 *Mode A/C ACAS I interference limits.* The interrogator power shall not exceed the following limits:

n_a	Upper limit for $\left\{ \sum_{k=1}^{k_t} P_a(k) \right\}$	
	If $f_r \leq 240$	If $f_r > 240$
0	250	118
1	250	113
2	250	108
3	250	103
4	250	98
5	250	94
6	250	89
7	250	84
8	250	79
9	250	74
10	245	70
11	228	65
12	210	60
13	193	55
14	175	50
15	158	45
16	144	41
17	126	36
18	109	31
19	91	26
20	74	21
21	60	17
≥ 22	42	12

where:

n_a = number of operating ACAS II and ACAS III equipped aircraft near own (based on ACAS broadcasts received with a transponder receiver threshold of -74 dBm);

{ } = average value of the expression within the brackets over last 8 interrogation cycles;

- $P_a(k)$ = peak power radiated from the antenna in all directions of the pulse having the largest amplitude in the group of pulses comprising a single interrogation during the k th Mode A/C interrogation in a 1 s interrogation cycle, W ;
- k = index number for Mode A/C interrogations, $k = 1, 2, \dots, k_i$;
- k_i = number of Mode A/C interrogations transmitted in a 1 s interrogation cycle;
- f_r = Mode A/C reply rate of own transponder.

4.2.3.3.4 *Mode S ACAS I interference limits.* An ACAS I that uses Mode S interrogations shall not cause greater interference effects than an ACAS I using Mode A/C interrogations only.

4.3 GENERAL PROVISIONS RELATING TO ACAS II AND ACAS III

Note 1.— The acronym ACAS is used in this section to indicate either ACAS II or ACAS III.

Note 2.— Carriage requirements for ACAS equipment are addressed in Annex 6.

Note 3.— The term “equipped threat” is used in this section to indicate a threat fitted with ACAS II or ACAS III.

4.3.1 Functional requirements

4.3.1.1 *ACAS functions.* ACAS shall perform the following functions:

- a) surveillance;
- b) generation of TAs;
- c) threat detection;
- d) generation of RAs;
- e) coordination; and
- f) communication with ground stations.

The equipment shall execute functions b) through e) on each cycle of operation.

Note.— Certain features of these functions must be standardized to ensure that ACAS units cooperate satisfactorily with other ACAS units, with Mode S ground stations and with the ATC system. Each of the features that are standardized is discussed below. Certain other features are given herein as recommendations.

4.3.1.1.1 The duration of a cycle shall not exceed 1.2 s.

4.3.2 Surveillance performance requirements

4.3.2.1 *General surveillance requirements.* ACAS shall interrogate SSR Mode A/C and Mode S transponders in other aircraft and detect the transponder replies. ACAS shall measure the range and relative bearing of responding aircraft. For ACAS X-compliant systems, in addition to information from other sources described above, ACAS shall be able to receive other aircraft’s ADS-B position, velocity and status information. Using these measurements and information conveyed by transponder replies and for ACAS X-compliant systems also by ADS-B messages, ACAS shall estimate the relative positions

of each responding aircraft. ACAS shall include provisions for achieving such position determination in the presence of ground reflections, interference and variations in signal strength.

4.3.2.1.1 *Track establishment probability.* ACAS shall generate an established track, with at least a 0.90 probability that the track is established 30 s before closest approach, on aircraft equipped with transponders when all of the following conditions are satisfied:

- a) the elevation angles of these aircraft are within ± 10 degrees relative to the ACAS aircraft pitch plane;
- b) the magnitudes of these aircraft's rates of change of altitude are less than or equal to 51 m/s (10 000 ft/min);
- c) the transponders and antennas of these aircraft meet the Standards of Chapter 3, 3.1.1 and 3.1.2;
- d) the closing speeds and directions of these aircraft, the local density of SSR transponder-equipped aircraft and the number of other ACAS interrogators in the vicinity (as determined by monitoring ACAS broadcasts, 4.3.7.1.2.4) satisfy the conditions specified in Table 4-1; and
- e) the minimum slant range is equal to or greater than 300 m (1 000 ft).

Table 4-1. ACAS design assumptions

Conditions								Performance		
Quadrant						Maximum traffic density		Maximum number of other ACAS within 56 km (30 NM)		Probability of success
Forward		Side		Back						
Maximum closing speed						aircraft/ km ²	aircraft/ NM ²			
m/s	kt	m/s	kt	m/s	kt					
260	500	150	300	93	180	0.087	0.30	30		0.90
620	1 200	390	750	220	430	0.017	0.06	30		0.90

Note.— Table 4-1 shows the design assumption upon which the development of ACAS was based. Operational experience and simulation show that ACAS provides adequate surveillance for collision avoidance even when the maximum number of other ACAS within 56 km (30 NM) is somewhat higher than that shown in Table 4-1. Future ACAS designs will take account of current and expected ACAS densities.

4.3.2.1.1.1 ACAS shall continue to provide surveillance with no abrupt degradation in track establishment probability as any one of the condition bounds defined in 4.3.2.1.1 is exceeded.

4.3.2.1.1.2 ACAS shall not track Mode S aircraft that report that they are on the ground.

Note.— A Mode S aircraft may report that it is on the ground by coding in the capability (CA) field in a DF = 11 or DF = 17 transmission (Chapter 3, 3.1.2.5.2.2.1) or by coding in the vertical status (VS) field in a DF = 0 transmission (Chapter 3, 3.1.2.8.2.1). Alternatively, if the aircraft is under Mode S ground surveillance, ground status may be determined by monitoring the flight status (FS) field in downlink formats DF = 4, 5, 20 or 21 (Chapter 3, 3.1.2.6.5.1).

4.3.2.1.1.3 **Recommendation.**— *ACAS should achieve the required tracking performance when the average SSR Mode A/C asynchronous reply rate from transponders in the vicinity of the ACAS aircraft is 240 replies per second and when the peak interrogation rate received by the individual transponders under surveillance is 500 per second.*

Note.— *The peak interrogation rate mentioned above includes interrogations from all sources.*

4.3.2.1.2 *False track probability.* The probability that an established Mode A/C track does not correspond in range and altitude, if reported, to an actual aircraft shall be less than 1.2 per cent. For an established Mode S track this probability shall be less than 0.1 per cent. These limits shall not be exceeded in any traffic environment.

4.3.2.1.3 RANGE AND BEARING ACCURACY

4.3.2.1.3.1 Range shall be measured with a resolution of 14.5 m (1/128 NM) or better.

4.3.2.1.3.2 **Recommendation.**— *The errors in the relative bearings of the estimated positions of intruders should not exceed 10 degrees rms.*

Note.— *This accuracy in the relative bearing of intruders is practicable and sufficient as an aid to the visual acquisition of potential threats. In addition, such relative bearing information has been found useful in threat detection, where it can indicate that an intruder is a threat. However, this accuracy is not sufficient as a basis for horizontal RAs, nor is it sufficient for reliable predictions of horizontal miss distance.*

4.3.2.2 INTERFERENCE CONTROL

4.3.2.2.1 *Maximum radiated RF power.* The effective radiated power of an ACAS transmission at 0 degree elevation relative to the longitudinal axis of the aircraft shall not exceed 27 dBW.

4.3.2.2.1.1 *Unwanted radiated power.* When ACAS is not transmitting an interrogation, the effective radiated power in any direction shall not exceed -70 dBm.

4.3.2.2.2 *Interference limiting.* Each ACAS interrogator operating below a pressure-altitude of 5 490 m (18 000 ft) shall control its interrogation rate or power or both so as to conform with specific inequalities (4.3.2.2.2.2).

4.3.2.2.2.1 *Determination of the number of other ACAS.* ACAS shall count the number of other ACAS II and III interrogators in the vicinity to ensure that the interference limits are met. This count shall be obtained by monitoring ACAS broadcasts (UF = 16), (4.3.7.1.2.4). Each ACAS shall monitor such broadcast interrogations to determine the number of other ACAS within detection range.

4.3.2.2.2.2 *ACAS interference limiting inequalities.* ACAS shall adjust its interrogation rate and interrogation power such that the following three inequalities remain true, except as provided in 4.3.2.2.2.2.1.

$$\left\{ \sum_{i=1}^{i_t} \left[\frac{p(i)}{250} \right]^\alpha \right\} < \text{minimum} \left[\frac{280}{1+n_a}, \frac{11}{\alpha^2} \right] \quad (1)$$

$$\left\{ \sum_{i=1}^{i_t} m(i) \right\} < 0.01 \quad (2)$$

$$\left\{ \frac{1}{B} \sum_{k=1}^{k_i} \frac{P_a(k)}{250} \right\} < \text{minimum} \left[\frac{80}{1+n_a}, 3 \right] \quad (3)$$

The variables in these inequalities shall be defined as follows:

i_t = number of interrogations (Mode A/C and Mode S) transmitted in a 1 s interrogation cycle. This shall include all Mode S interrogations used by the ACAS functions, including those in addition to UF = 0 and UF = 16 interrogations, except as provided in 4.3.2.2.2.1;

Note. — UF = 19 interrogations are included in i_t as specified in 3.1.2.8.9.4.

i = index number for Mode A/C and Mode S interrogations, $i = 1, 2, \dots, i_i$;

α = the minimum of α_1 calculated as $1/4 [n_b/n_c]$ subject to the special conditions given below and α_2 calculated as $\text{Log}_{10} [n_a/n_b] / \text{Log}_{10} 25$, where n_b and n_c are defined as the number of operating ACAS II and ACAS III equipped aircraft (airborne or on the ground) within 11.2 km (6 NM) and 5.6 km (3 NM) respectively, of own ACAS (based on ACAS surveillance). ACAS aircraft operating on the ground or at or below a radio altitude of 610 m (2 000 ft) AGL shall include both airborne and on-ground ACAS II and ACAS III aircraft in the value for n_b and n_c . Otherwise, ACAS shall include only airborne ACAS II and ACAS III aircraft in the value for n_b and n_c . The values of α , α_1 and α_2 are further constrained to a minimum of 0.5 and a maximum of 1.0.

In addition;

IF $[(n_b \leq 1) \text{ OR } (n_b \leq 4 \text{ AND } n_c \leq 2 \text{ AND } n_a > 25)]$ THEN $\alpha_1 = 1.0$,

IF $[(n_c > 2) \text{ AND } (n_b > 2 n_c) \text{ AND } (n_a < 40)]$ THEN $\alpha_1 = 0.5$;

$p(i)$ = peak power radiated from the antenna in all directions of the pulse having the largest amplitude in the group of pulses comprising a single interrogation during the i th interrogation in a 1 s interrogation cycle, W;

$m(i)$ = duration of the mutual suppression interval for own transponder associated with the i th interrogation in a 1 s interrogation cycle, s;

B = beam sharpening factor (ratio of 3 dB beam width to beamwidth resulting from interrogation side-lobe suppression). For ACAS interrogators that employ transmitter side-lobe suppression (SLS), the appropriate beamwidth shall be the extent in azimuth angle of the Mode A/C replies from one transponder as limited by SLS, averaged over the transponder population;

{ } see 4.2.3.3.3

$P_a(k)$ "
 k "
 k_i "
 n_a "

Note. — RA and ACAS broadcasts (4.3.6.2.1 and 4.3.7.1.2.4) are interrogations.

4.3.2.2.2.2.1 *Transmissions during RAs.* All air-to-air coordination interrogations shall be transmitted at full power and these interrogations shall be excluded from the summations of Mode S interrogations in the left-hand terms of inequalities (1) and (2) in 4.3.2.2.2.2 for the duration of the RA.

4.3.2.2.2.2 *Transmissions from ACAS units on the ground.* Whenever the ACAS aircraft indicates that it is on the ground, ACAS interrogations shall be limited by setting the number of other ACAS II and III aircraft (n_a) count in the interference limiting inequalities to a value that is three times the value obtained based on ACAS broadcasts received with a transponder receiver threshold of -74 dBm. Whenever Mode A/C interrogation power is reduced because of interference limiting, the Mode A/C interrogation power in the forward beam shall be reduced first until the forward sequence matches the right and left sequences. The forward, right and left interrogation powers shall then sequentially be reduced until they match the rear interrogation power. Further reduction of Mode A/C power shall be accomplished by sequentially reducing the forward, side and rear interrogation powers.

4.3.2.2.2.3 *Transmissions from ACAS units above 5 490 m (18 000 ft) altitude.* Each ACAS interrogator operating above a pressure-altitude of 5 490 m (18 000 ft) shall control its interrogation rate or power or both such that inequalities (1) and (3) in 4.3.2.2.2 remain true when n_a and α are equal to 1, except as provided in 4.3.2.2.2.1.

4.3.3 Traffic advisories (TAs)

4.3.3.1 *TA function.* ACAS shall provide TAs to alert the flight crew to potential threats. Such TAs shall be accompanied by an indication of the approximate relative position of potential threats to facilitate visual acquisition.

4.3.3.1.1 *Display of potential threats.* If potential threats are shown on a traffic display, they shall be displayed in amber or yellow.

Note 1.— These colours are generally considered suitable for indicating a cautionary condition.

Note 2.— Additional information assisting in the visual acquisition such as vertical trend and relative altitude may be displayed as well.

Note 3.— Traffic situational awareness is improved when tracks can be supplemented by display of heading information (e.g. as extracted from received ADS-B messages).

4.3.3.2 PROXIMATE TRAFFIC DISPLAY

4.3.3.2.1 **Recommendation.**— *While any RA and/or TA are displayed, proximate traffic within 11 km (6 NM) range and, if altitude reporting, ± 370 m (1 200 ft) altitude should be displayed. This proximate traffic should be distinguished (e.g. by colour or symbol type) from threats and potential threats, which should be more prominently displayed.*

4.3.3.2.2 **Recommendation.**— *While any RA and/or TA are displayed, visual acquisition of the threats and/or potential threat should not be adversely affected by the display of proximate traffic or other data unrelated to collision avoidance.*

4.3.3.3 *TAs as RA precursors.* The criteria for TAs shall be such that they are satisfied before those for an RA.

Note. — Ideally, RAs would always be preceded by a TA but this is not always possible, e.g. the RA criteria might be already satisfied when a track is first established, or a sudden and sharp manoeuvre by the intruder could cause the TA lead time to be less than a cycle.

4.3.3.3.1 *TA warning time.*

4.3.3.3.1.1 For TCAS Version 7.1-compliant systems, the nominal TA warning time for intruders reporting altitude shall not be greater than $(T+20)$ s where T is the nominal warning time for the generation of the resolution advisory.

4.3.3.3.1.2 For ACAS X-compliant systems, the TA warning time shall be sufficient to allow the flight crew to take actions described in PANS-OPS, Volume III and prepare for a potential resolution advisory.

Note.— The nominal TA warning time is 20 s or less before the generation of the resolution advisory.

4.3.4 Threat detection

4.3.4.1 *Declaration of threat.* ACAS shall evaluate appropriate characteristics of each intruder to determine whether or not it is a threat.

4.3.4.1.1 *Intruder characteristics.* As a minimum, the characteristics of an intruder that are used to identify a threat shall include:

- a) tracked altitude;
- b) tracked rate of change of altitude;
- c) tracked slant range;
- d) tracked rate of change of slant range; and
- e) for TCAS Version 7.1-compliant systems: sensitivity level of intruder's ACAS, S_i .

For an intruder not equipped with ACAS II or ACAS III, S_i shall be set to 1.

4.3.4.1.2 *Own aircraft characteristics.* As a minimum, the characteristics of own aircraft that are used to identify a threat shall include:

- a) altitude;
- b) rate of change of altitude; and
- c) sensitivity level of own ACAS (4.3.4.3).

4.3.4.2 *Sensitivity levels.* ACAS shall be capable of operating at any of a number of sensitivity levels. These shall include:

- a) $S = 1$, a “standby” mode in which the interrogation of other aircraft and all advisories are inhibited;
- b) $S = 2$, a “TA only” mode in which RAs are inhibited;
- c) for TCAS Version 7.1-compliant systems: $S = 3-7$, further levels that enable the issue of RAs that provide the warning times indicated in Table 4-2 as well as TAs; and
- d) for ACAS X-compliant systems: $S = 3$, a “TA/RA” mode in which RAs and TAs can be issued.

4.3.4.3 *Selection of own sensitivity level (S_o).* The selection of own ACAS sensitivity level shall be determined by sensitivity level control (SLC) commands which shall be accepted from a number of sources as follows:

- a) SLC command generated automatically by ACAS based on altitude band or other external factors;
- b) SLC command from pilot input; and
- c) for TCAS Version 7.1-compliant systems: SLC command from Mode S ground stations.

Note. — ACAS X-compliant systems acknowledge SLC commands from ground stations so that the ground stations do not need to be modified for these commands. However, the sensitivity level value is not used in ACAS X-compliant systems.

Table 4-2

For TCAS Version 7.1-compliant systems:

<i>Sensitivity level</i>	2	3	4	5	6	7
Nominal warning time	no RAs	15s	20s	25s	30s	35s

4.3.4.3.1 *Permitted SLC command codes.* As a minimum, the acceptable SLC command codes shall include:

		<i>Coding</i>
for SLC based on altitude band	2-7	(for TCAS Version 7.1-compliant systems)
	2-3	(for ACAS X-compliant systems)
for SLC from pilot input	0,1,2	
for SLC from Mode S ground stations	0,2-6	(for TCAS Version 7.1-compliant systems)

4.3.4.3.2 *Altitude-band SLC command.* Where ACAS selects an SLC command based on altitude, hysteresis shall be applied to the nominal altitude thresholds at which SLC command value changes are required as follows: for a climbing ACAS aircraft the SLC command shall be increased at the appropriate altitude threshold plus the hysteresis value; for a descending ACAS aircraft the SLC command shall be decreased at the appropriate altitude threshold minus the hysteresis value.

4.3.4.3.3 *Pilot SLC command.* For the SLC command set by the pilot the value 0 shall indicate the selection of the “automatic” mode for which the sensitivity level selection shall be based on the other commands.

4.3.4.3.4 *Mode S ground station SLC command.*

4.3.4.3.4.1 For TCAS Version 7.1-compliant systems: For SLC commands transmitted via Mode S ground stations (4.3.8.4.2.1.1), the value 0 shall indicate that the station concerned is not issuing an SLC command and that sensitivity level selection shall be based on the other commands, including non-0 commands from other Mode S ground stations. ACAS shall not process an uplinked SLC value of 1.

4.3.4.3.4.2 For ACAS X-compliant systems: ACAS shall receive any SLC commands from Mode S ground stations but shall not use their sensitivity level values.

4.3.4.3.4.3 *ATS selection of SLC command code.* ATS authorities shall ensure that procedures are in place to inform pilots of any ATS selected SLC command code other than 0 (4.3.4.3.1).

4.3.4.3.5 *Selection rule.* Own ACAS sensitivity level shall be set to the smallest non-0 SLC command received from any of the sources listed in 4.3.4.3.

4.3.4.4 *Selection of parameter values for RA generation.* For TCAS Version 7.1-compliant systems: When the sensitivity level of own ACAS is 3 or greater, the parameter values used for RA generation that depend on sensitivity level shall be based on the greater of the sensitivity level of own ACAS, S_o , and the sensitivity level of the intruder’s ACAS, S_i .

4.3.4.5 *Selection of parameter values for TA generation.* For TCAS Version 7.1-compliant systems: The parameter values used for TA generation that depend on sensitivity level shall be selected on the same basis as those for RAs (4.3.4.4) except when an SLC command with a value of 2 (“TA only” mode) has been received from either the pilot or a Mode S ground station. In this case, the parameter values for TA generation shall retain the values they would have had in the absence of the SLC command from the pilot or Mode S ground station.

4.3.4.6 *Validation of ADS-B tracks for RA generation.* For ACAS X-compliant systems: If ADS-B tracks fail validation via active interrogation and reply, ACAS shall revert back to using active surveillance for threat resolution logic.

Note.— Only validated ADS-B is used in the generation of RAs.

4.3.4.7 *Designation of aircraft for do not alert (DNA).* For ACAS X-compliant systems with Xo functionality: If an intruder aircraft is designated as do not alert (DNA), no alerts for the intruder aircraft shall be issued to the flight crew of the own aircraft.

Note. — ACAS Xo provides additional modes with modified threat detection criteria in respect of designated intruders. For more details on ACAS Xo, refer to RTCA/DO-385 or EUROCAE/ED-256.

4.3.5 Resolution advisories (RAs)

4.3.5.1 *RA generation.* For all threats, ACAS shall generate an RA except where it is not possible to select an RA that can be predicted to provide adequate separation either because of uncertainty in the diagnosis of the intruder's flight path or because there is a high risk that a manoeuvre by the threat will negate the RA.

4.3.5.1.1 *Display of threats.* If threats are shown on a traffic display, they shall be displayed in red.

Note.— This colour is generally considered suitable for indicating a warning condition.

4.3.5.1.2 *RA cancellation.*

4.3.5.1.2.1 For TCAS 7.1-compliant systems: Once an RA has been generated against a threat or threats it shall be maintained or modified until tests that are less stringent than those for threat detection indicate on two consecutive cycles that the RA may be cancelled, at which time it shall be cancelled.

4.3.5.1.2.2 For ACAS X-compliant systems: Once an RA has been generated against a threat or threats it shall be maintained until the intruder or intruders of the RA cease to be a threat.

4.3.5.2 *RA selection.* ACAS shall generate the RA that is predicted to provide adequate separation from all threats and that has the least effect on the current flight path of the ACAS aircraft consistent with the other provisions in this chapter.

4.3.5.3 *RA effectiveness.* The RA shall not recommend or continue to recommend a manoeuvre or manoeuvre restriction that, considering the range of probable threat trajectories, is more likely to reduce separation than increase it, subject to the provisions in 4.3.5.5.1.1 and 4.3.5.6.

Note.— See also 4.3.5.8.

4.3.5.3.1 New ACAS installations after 1 January 2014 shall monitor own aircraft's vertical rate to verify compliance with the RA sense. If non-compliance is detected, ACAS shall stop assuming compliance, and instead shall assume the observed vertical rate.

Note 1.— This overcomes the retention of an RA sense that would work only if followed. The revised vertical rate assumption is more likely to allow the logic to select the opposite sense when it is consistent with the non-complying aircraft's vertical rate.

Note 2.— Equipment complying with RTCA/DO-185 or DO-185A standards (also known as TCAS Version 6.04A or TCAS Version 7.0) do not comply with this requirement.

Note 3.— Compliance with this requirement can be achieved through the implementation of traffic alert and collision avoidance system (TCAS) Version 7.1 as specified in RTCA/DO-185B, EUROCAE/ED-143 or airborne collision avoidance system X (ACAS Xa and Xo) as specified in RTCA/DO 385 or EUROCAE/ED-256.

4.3.5.3.2 **Recommendation.**— All ACAS should be compliant with the requirement in 4.3.5.3.1.

4.3.5.3.3 After 1 January 2017, all ACAS units shall comply with the requirements stated in 4.3.5.3.1.

4.3.5.4 *Aircraft capability.* The RA generated by ACAS shall be consistent with the performance capability of the aircraft.

4.3.5.4.1 *Proximity to the ground.* Descend RAs shall not be generated or maintained when own aircraft is below 300 m (1 000 ft) AGL nominal value with hysteresis applied

4.3.5.4.2 ACAS shall operate in TA-only mode when own aircraft is below 300 m (1 000 ft) AGL nominal value with hysteresis applied.

4.3.5.5 *Reversals of sense.* ACAS shall not reverse the sense of an RA from one cycle to the next, except as permitted in 4.3.5.5.1 to ensure coordination or when the predicted separation at closest approach for the existing sense is inadequate.

4.3.5.5.1 *Sense reversals against equipped threats.* If an RAC received from an equipped threat is incompatible with the current RA sense, ACAS shall modify the RA sense to conform with the received RAC if own aircraft address is higher in value than that of the threat.

Note.— 4.3.6.1.3 requires that the own ACAS RAC for the threat is also reversed.

4.3.5.5.1.1 ACAS shall not modify an RA sense in a way that makes it incompatible with an RAC received from an equipped threat if own aircraft address is higher in value than that of the threat.

4.3.5.5.2 *Sense reversals due to inadequate predicted separation.* ACAS shall initiate not more than one reversal per threat per encounter due to inadequate predicted separation.

Note 1.— For TCAS Version 7.1-compliant systems: The aircraft with the lower 24-bit aircraft address can initiate this type of reversal at any time during the encounter; the aircraft with the higher 24-bit aircraft address performs this type of reversal only to comply with an RAC received from the aircraft with a lower 24-bit aircraft address.

Note 2.— For ACAS X-compliant systems: In a coordinated encounter as described in section 4.3.6.1, the aircraft with the lower 24-bit aircraft address can initiate this type of reversal at any time during the encounter; the aircraft with the higher 24-bit aircraft address can initiate this type of reversal only before it has received an RAC from the threat or after receiving cancellation of any remaining RAC from the threat.

4.3.5.6 *RA strength retention.* Subject to the requirement that a descend RA is not generated at low altitude (4.3.5.4.1), an RA shall not be modified if the time to closest approach is too short to achieve a significant response or if the threat is diverging in range.

4.3.5.7 *Weakening an RA.* An RA shall not be weakened if it is likely that it would subsequently need to be strengthened.

4.3.5.8 *ACAS-equipped threats.* The RA shall be compatible with all the RACs transmitted to threats (4.3.6.1.3). If an RAC is received from a threat before own ACAS generates an RAC for that threat, the RA generated shall be compatible with the RAC received unless such an RA is more likely to reduce separation than increase it and own aircraft address is lower in value than that of the threat.

Note.— In encounters with more than one threat where it is necessary to pass above some threats and below other threats, this standard can be interpreted as referring to the whole duration of the RA. Specifically, it is permissible to retain an RA to climb (descend) towards a threat that is above (below) own aircraft provided there is a calculated intention to provide adequate separation from all threats by subsequently levelling-off.

4.3.5.9 *Encoding of ARA subfield.* On each cycle of an RA, the RA sense, strength and attributes shall be encoded in the active RA (ARA) subfield (4.3.8.4.2.2.1.1).

4.3.5.10 *System response time.* The system delay from receipt of the relevant SSR reply to presentation of an RA sense and strength to the pilot shall be as short as possible and shall not exceed 1.5 s.

4.3.6 Coordination and communication

4.3.6.1 PROVISIONS FOR COORDINATION WITH ACAS-EQUIPPED THREATS

Note 1.— The provisions in this section apply to aircraft that coordinate with ACAS-equipped aircraft via 1 030/1 090 MHz discrete Mode S interrogations/replies.

Note 2.— ACAS equipment not capable of utilizing 1 030/1 090 MHz discrete Mode S interrogations/replies and that will use ADS-B to convey the applicable coordination scheme is under development. ACAS X-compliant systems incorporate the ability to coordinate with threats using such ACAS equipment. For more details, refer to Section 2.2.3.9.3.1 of RTCA/DO-385 or EUROCAE/ED-256.

4.3.6.1.1 *Multi-aircraft coordination.* In a multi-aircraft situation, ACAS shall coordinate with each equipped threat individually.

4.3.6.1.2 *Data protection during coordination.* ACAS shall prevent simultaneous access to stored data by concurrent processes, in particular, during resolution message processing.

4.3.6.1.3 *Coordination interrogation.* Each cycle ACAS shall transmit a coordination interrogation to each equipped threat, unless generation of an RA is delayed because it is not possible to select an RA that can be predicted to provide adequate separation (4.3.5.1). The resolution message transmitted to a threat shall include an RAC selected for that threat. If an RAC has been received from the threat before ACAS selects an RAC for that threat, the selected RAC shall be compatible with the received RAC unless no more than three cycles have elapsed since the RAC was received, the RAC is altitude-crossing, and own aircraft address is lower in value than that of the threat in which case ACAS shall select its RA independently. If an RAC received from an equipped threat is incompatible with the RAC own ACAS has selected for that threat, ACAS shall modify the selected RAC to be compatible with the received RAC if own aircraft address is higher in value than that of the threat.

Note.— The RAC included in the resolution message is in the form of a vertical RAC (VRC) for ACAS II (4.3.8.4.2.3.2.2) and a vertical RAC (VRC) and/or horizontal RAC (HRC) for ACAS III.

4.3.6.1.3.1 *Coordination termination.* Within the cycle during which an intruder ceases to be a reason for maintaining the RA, ACAS shall send a resolution message to that intruder by means of a coordination interrogation. The resolution message shall include the cancellation code for the last RAC sent to that intruder while it was a reason for maintaining the RA.

Note.— During an encounter with a single threat, the threat ceases to be a reason for the RA when the conditions for cancelling the RA are met. During an encounter with multiple threats, a threat ceases to be a reason for the RA when the conditions for cancelling the RA are met in respect of that threat, even though the RA may have to be maintained because of other threats.

4.3.6.1.3.2 ACAS coordination interrogations shall be transmitted until a coordination reply is received from the threat, up to a maximum of not less than six and not more than twelve attempts. The successive interrogations shall be nominally equally spaced over a period of 100 ± 5 ms. If the maximum number of attempts is made and no reply is received, ACAS shall continue its regular processing sequence.

4.3.6.1.3.3 ACAS shall provide parity protection (4.3.8.4.2.3.2.6 and 4.3.8.4.2.3.2.7) for all fields in the coordination interrogation that convey RAC information.

Note.— This includes the vertical RAC (VRC), the cancel vertical RAC (CVC), the horizontal RAC (HRC) and the cancel horizontal RAC (CHC).

4.3.6.1.3.4 Whenever own ACAS reverses its sense against an equipped threat, the resolution message that is sent on the current and subsequent cycles to that threat shall contain both the newly selected RAC and the cancellation code for the RAC sent before the reversal.

4.3.6.1.3.5 When a vertical RA is selected, the vertical RAC (VRC) (4.3.8.4.2.3.2.2) that own ACAS includes in a resolution message to the threat shall be as follows:

- a) “do not pass above” when the RA is intended to provide separation above the threat;
- b) “do not pass below” when the RA is intended to provide separation below the threat.

4.3.6.1.4 *Resolution message processing.* Resolution messages shall be processed in the order in which they are received and with delay limited to that required to prevent possible concurrent access to stored data and delays due to the processing of previously received resolution messages. Resolution messages that are being delayed shall be temporarily queued to prevent possible loss of messages. Processing a resolution message shall include decoding the message and updating the appropriate data structures with the information extracted from the message.

Note 1.— For TCAS Version 7.1-compliant systems: According to 4.3.6.1.2, resolution message processing must not access any data whose usage is not protected by the coordination lock state.

Note 2.— For ACAS X-compliant systems: Simultaneous data access may exist because incoming resolution messages are received asynchronously to ACAS X processing, effectively interrupting this processing. Simultaneous reading and writing by concurrent processes are to be prevented.

4.3.6.1.4.1 An RAC or an RAC cancellation received from another ACAS shall be rejected if the encoded sense bits indicate the existence of a parity error or if undefined value(s) are detected in the resolution message. An RAC or an RAC cancellation received without parity errors and without undefined resolution message values shall be considered valid.

4.3.6.1.4.2 *RAC storage.* A valid RAC received from another ACAS shall be stored or shall be used to update the previously stored RAC corresponding to that ACAS. A valid RAC cancellation shall cause the previously stored RAC to be deleted. A stored RAC that has not been updated for an interval of 6 s shall be deleted.

4.3.6.1.4.3 *RAC record update.* A valid RAC or RAC cancellation received from another ACAS shall be used to update the RAC record. If a bit in the RAC record has not been refreshed for an interval of 6 s by any threat, that bit shall be set to 0.

4.3.6.2 PROVISIONS FOR ACAS COMMUNICATION WITH GROUND STATIONS

4.3.6.2.1 *Air-initiated downlink of ACAS RAs.* When an ACAS RA exists, ACAS shall:

- a) transfer to its Mode S transponder an RA report for transmission to the ground in a Comm-B reply (4.3.11.4.1); and
- b) transmit periodic RA broadcasts (4.3.7.3.2).

4.3.6.2.2 *Sensitivity level control (SLC) command.* For TCAS Version 7.1-compliant systems: ACAS shall store SLC commands from Mode S ground stations. An SLC command received from a Mode S ground station shall remain effective until replaced by an SLC command from the same ground station as indicated by the site number contained in the IIS subfield of the interrogation. If an existing stored command from a Mode S ground station is not refreshed within 4 minutes, or if the SLC command received has the value 15 (4.3.8.4.2.1.1), the stored SLC command for that Mode S ground station shall be set to 0.

Note.— ACAS X-compliant systems do not use the sensitivity level value obtained from an SLC command to modify the sensitivity level value of own aircraft.

4.3.6.3 PROVISIONS FOR DATA TRANSFER BETWEEN ACAS AND ITS MODE S TRANSPONDER

4.3.6.3.1 Data transfer from ACAS to its Mode S transponder:

- a) ACAS shall transfer RA information to its Mode S transponder for transmission in an RA report (4.3.8.4.2.2.1) and in a coordination reply (4.3.8.4.2.4.2);

- b) ACAS shall transfer current sensitivity level to its Mode S transponder for transmission in a sensitivity level report (4.3.8.4.2.5); and
- c) ACAS shall transfer capability information to its Mode S transponder for transmission in a data link capability report (4.3.8.4.2.2.3).

Note.— For ACAS X-compliant systems: ACAS will not transfer a sensitivity level value greater than 3 as part of the capability information to its Mode S transponder.

4.3.6.3.2 Data transfer from Mode S transponder to its ACAS:

- a) ACAS shall receive from its Mode S transponder sensitivity level control commands (4.3.8.4.2.1.1) transmitted by Mode S ground stations;

Note.— For ACAS X-compliant systems: It is necessary to receive SLC commands from the transponder to be compliant with the interface protocols between the Mode S transponder and the ACAS unit; however, the sensitivity level values are not used (refer to 4.3.4.3.4).

- b) ACAS shall receive from its Mode S transponder ACAS broadcast messages (4.3.8.4.2.3.3) transmitted by other ACAS; and
- c) ACAS shall receive from its Mode S transponder resolution messages (4.3.8.4.2.3.2) transmitted by other ACAS for air-air coordination purposes.

4.3.7 ACAS protocols

4.3.7.1 SURVEILLANCE PROTOCOLS

4.3.7.1.1 SURVEILLANCE OF MODE A/C TRANSPONDERS

4.3.7.1.1.1 ACAS shall use the Mode C-only all-call interrogation (Chapter 3, 3.1.2.1.5.1.2) for surveillance of aircraft equipped with Mode A/C transponders.

4.3.7.1.1.2 Using a sequence of interrogations with increasing power, surveillance interrogations shall be preceded by an S_1 -pulse (Chapter 3, 3.1.1.7.4.3) to reduce interference and improve Mode A/C target detection.

4.3.7.1.2 SURVEILLANCE OF MODE S TRANSPONDERS

4.3.7.1.2.1 *Detection.* ACAS shall monitor 1 090 MHz for Mode S acquisition squitters (DF = 11). ACAS shall detect the presence and determine the address of Mode S-equipped aircraft using their Mode S acquisition squitters (DF = 11) or extended squitters (DF = 17).

Note 1.— It is acceptable to acquire individual aircraft using either acquisition or extended squitters (DF = 11 or DF = 17), and to monitor for both squitters. However, ACAS must monitor for acquisition squitters because, at any time, not all aircraft will transmit the extended squitter.

Note 2.— If, in the future, it becomes permitted for aircraft not to transmit the acquisition squitter, relying instead on continual transmission of the extended squitter, it would become essential for all ACAS units to monitor for both the acquisition and the extended squitters.

4.3.7.1.2.2 *Surveillance interrogations.* On first receipt of a 24-bit aircraft address from an aircraft that is determined to be within the reliable surveillance range of ACAS based on reception reliability and that is within an altitude band 3 050 m

(10 000 ft) above and below own aircraft, ACAS shall transmit a short air-air interrogation (UF = 0) for range acquisition. Surveillance interrogations shall be transmitted at least once every five cycles when this altitude condition is satisfied. Surveillance interrogations shall be transmitted each cycle if the range of the detected aircraft is less than 5.6 km (3 NM) or the calculated time to closest approach is less than 60 s, assuming that both the detected and own aircraft proceed from their current positions with unaccelerated motion and that the range at closest approach equals 5.6 km (3 NM). Surveillance interrogations shall be suspended for a period of five cycles if:

- a) a reply was successfully received; and
- b) own aircraft and intruder aircraft are operating below a pressure-altitude of 5 490 m (18 000 ft); and
- c) the range of the detected aircraft is greater than 5.6 km (3 NM) and the calculated time to closest approach exceeds 60 seconds, assuming that both the detected and own aircraft proceed from their current positions with unaccelerated motion and that the range at closest approach equals 5.6 km (3 NM).

4.3.7.1.2.2.1 *Range acquisition interrogations.* ACAS shall use the short air-air surveillance format (UF = 0) for range acquisition. ACAS shall set AQ = 1 (Chapter 3, 3.1.2.8.1.1) and RL = 0 (Chapter 3, 3.1.2.8.1.2) in an acquisition interrogation.

Note 1.— Setting AQ = 1 results in a reply with bit 14 of the RI field equal to 1 and serves as an aid in distinguishing the reply to own interrogation from replies elicited from other ACAS units (4.3.7.1.2.2.2).

Note 2.— In the acquisition interrogation RL is set to 0 to command a short acquisition reply (DF = 0).

4.3.7.1.2.2.2 *Tracking interrogations.* ACAS shall use the short air-air surveillance format (UF = 0) with RL = 0 and AQ = 0 for tracking interrogations.

4.3.7.1.2.3 *Surveillance replies.* These protocols are described in 4.3.11.3.1.

4.3.7.1.2.4 *ACAS broadcast.* An ACAS broadcast shall be made nominally every 8 to 10 s at full power from the top antenna. Installations using directional antennas shall operate such that complete circular coverage is provided nominally every 8 to 10 s.

Note.— A broadcast causes other Mode S transponders to accept the interrogation without replying and to present the interrogation content containing the MU field at the transponder output data interface. The UDS1 = 3, UDS2 = 2 combination identifies the data as an ACAS broadcast containing the 24-bit address of the interrogating ACAS aircraft. This provides each ACAS with a means of determining the number of other ACAS within its detection range for limiting interference. The format of the MU field is described in 4.3.8.4.2.3.

4.3.7.1.3 SURVEILLANCE OF ADS-B MESSAGES FROM INTRUDER AIRCRAFT FOR ACAS X-COMPLIANT SYSTEMS:

4.3.7.1.3.1 *Detection.* ACAS shall monitor 1 090 MHz extended squitter.

4.3.7.1.3.2 ACAS shall receive and use 1 090 MHz extended squitter messages which include information on ADS-B airborne and surface position, airborne velocity, target state and status, and aircraft operational status.

4.3.7.2 AIR-AIR COORDINATION PROTOCOLS

Note 1.— The provisions in this section apply to aircraft that coordinate with ACAS-equipped aircraft via 1 030/1 090 MHz discrete Mode S interrogations/replies.

Note 2.— ACAS equipment not capable of utilizing 1 030/1 090 MHz discrete Mode S interrogations/replies and that will use ADS-B to convey the applicable coordination scheme is under development. ACAS X-compliant systems incorporate the ability to coordinate with threats using such ACAS equipment. For more details, refer to Section 2.2.3.9.3.1 of RTCA/DO-385 or EUROCAE/ED-256.

4.3.7.2.1 *Coordination interrogations.* ACAS shall transmit UF = 16 interrogations (Chapter 3, 3.1.2.3.2, Figure 3-7) with AQ = 0 and RL = 1 when another aircraft reporting RI = 3 or 4 is declared a threat (4.3.4). The MU field shall contain the resolution message in the subfields specified in 4.3.8.4.2.3.2.

Note 1.— A UF = 16 interrogation with AQ = 0 and RL = 1 is intended to cause a DF = 16 reply from the other aircraft.

Note 2.— An aircraft reporting RI = 3 or RI = 4 is an aircraft equipped with an operating ACAS which has vertical only or vertical and horizontal resolution capability, respectively.

4.3.7.2.2 *Coordination reply.* These protocols are described in 4.3.11.3.2.

4.3.7.3 PROTOCOLS FOR ACAS COMMUNICATION WITH GROUND STATIONS

4.3.7.3.1 *RA reports to Mode S ground stations.* These protocols are described in 4.3.11.4.1.

4.3.7.3.2 *RA broadcasts.* RA broadcasts shall be transmitted at full power from the bottom antenna at jittered intervals. The RA broadcast shall include the MU field as specified in 4.3.8.4.2.3.4. The RA broadcast shall describe the current RA. Installations using directional antennas shall operate such that complete circular coverage is provided.

Note. — The nominal jittered interval of RA broadcasts is every 8 s for the majority of ACAS legacy systems and 1 s for ACAS X-compliant systems.

4.3.7.3.3 *Data link capability report.* These protocols are described in 4.3.11.4.2.

4.3.7.3.4 *ACAS sensitivity level control.*

4.3.7.3.4.1 For TCAS Version 7.1-compliant systems: ACAS shall act upon an SLC command if and only if TMS (Chapter 3, 3.1.2.6.1.4.1) has the value 0 and DI is either 1 or 7 in the same interrogation.

4.3.7.3.4.2 For ACAS X-compliant systems: ACAS shall receive any SLC commands from Mode S ground stations but shall not use their sensitivity level values.

4.3.8 Signal formats

4.3.8.1 The RF characteristics of all ACAS signals shall conform to the Standards of Chapter 3, 3.1.1.1 through 3.1.1.6, 3.1.2.1 through 3.1.2.3, 3.1.2.5 and 3.1.2.8.

4.3.8.2 RELATIONSHIP BETWEEN ACAS AND MODE S SIGNAL FORMATS

Note.— ACAS uses Mode S transmissions for surveillance and communications. ACAS air-air communication functions permit RA decisions to be coordinated with ACAS-equipped threats. ACAS air-ground communication functions permit the reporting of RAs to ground stations.

4.3.8.3 *Signal format conventions.* The data encoding of all ACAS signals shall conform to the Standards of Chapter 3, 3.1.2.3.

Note.— In air-air transmissions used by ACAS, interrogations transmitted at 1 030 MHz are designated as uplink transmissions and contain uplink format (UF) codes. Replies received at 1 090 MHz are designated as downlink transmissions and contain downlink format (DF) codes.

4.3.8.4 FIELD DESCRIPTION

Note 1.— The air-air surveillance and communication formats which are used by ACAS but not fully described in Chapter 3, 3.1.2 are given in Figure 4-1.

Note 2.— This section defines the Mode S fields (and their subfields) that are processed by ACAS to accomplish ACAS functions. Some of the ACAS fields (those also used for other SSR Mode S functions) are described with unassigned ACAS codes in Chapter 3, 3.1.2.6. Such codes are assigned in 4.3.8.4.1. Fields and subfields used only by ACAS equipment are assigned in 4.3.8.4.2.

Note 3.— The bit numbering convention used in 4.3.8.4 reflects the bit numbering within the entire uplink or downlink format rather than the bits within individual fields or subfields.

Uplink:										
UF = 0	00000	3	RL:1	4	AQ:1	DS:8	10	AP:24		
UF = 16	10000	3	RL:1	4	AQ:1	18	MU:56	AP:24		
Downlink:										
DF = 0	00000	VS:1	CC:1	1	SL:3	2	RI:4	2	AC:13	AP:24
DF = 16	10000	VS:1	2	SL:3	2	RI:4	2	AC:13	MV:56	AP:24

Figure 4-1. Surveillance and communication formats used by ACAS

4.3.8.4.1 FIELDS AND SUBFIELDS INTRODUCED IN CHAPTER 3, 3.1.2

Note.— Codes for mission fields and subfields that are designated “reserved for ACAS” in Chapter 3, 3.1.2, are specified in this section.

4.3.8.4.1.1 *DR (downlink request).* The significance of the coding of the downlink request field shall be as follows:

Coding

- 0-1 See Chapter 3, 3.1.2.6.5.2
- 2 ACAS message available
- 3 Comm-B message available and ACAS message available
- 4-5 See Chapter 3, 3.1.2.6.5.2
- 6 Comm-B broadcast message 1 available and ACAS message available
- 7 Comm-B broadcast message 2 available and ACAS message available
- 8-31 See Chapter 3, 3.1.2.6.5.2

4.3.8.4.1.2 *RI (air-air reply information).* The significance of the coding in the RI field shall be as follows:

Coding

- 0 No operating ACAS
- 1 Not assigned
- 2 ACAS with resolution capability inhibited
- 3 ACAS with vertical-only resolution capability and capability to utilize 1 030/1 090 MHz discrete Mode S interrogations/replies for coordination
- 4 ACAS with vertical and horizontal resolution capability and capability to utilize 1 030/1 090 MHz discrete Mode S interrogations/replies for coordination
- 5-6 Reserved for passive ACAS
- 7 Not assigned
- 8-15 See Chapter 3, 3.1.2.8.2.2

Bit 14 of the reply format containing this field shall replicate the AQ bit of the interrogation. The RI field shall report “no operating ACAS” (RI = 0) if the ACAS unit has failed or is in standby. The RI field shall report “ACAS with resolution capability inhibited” (RI = 2) if sensitivity level is 2 or TA only mode has been selected.

Note.— Codes 0-7 in the RI field indicate that the reply is a tracking reply and also give the ACAS capability of the interrogated aircraft. Codes 8-15 indicate that the reply is an acquisition reply and also give the maximum true airspeed capability of the interrogated aircraft.

4.3.8.4.1.3 *RR (reply request).* The significance of the coding in the reply request field shall be as follows:

Coding

- 0-18 See Chapter 3, 3.1.2.6.1.2
- 19 Transmit a resolution advisory report
- 20-31 See Chapter 3, 3.1.2.6.1.2

4.3.8.4.2 ACAS FIELDS AND SUBFIELDS

Note.— The following paragraphs describe the location and coding of those fields and subfields that are not defined in Chapter 3, 3.1.2 but are used by aircraft equipped with ACAS.

4.3.8.4.2.1 For TCAS Version 7.1-compliant systems: Subfield in MA

4.3.8.4.2.1.1 ADS (A-definition subfield). This 8-bit (33-40) subfield shall define the remainder of MA.

Note.— For convenience of coding, ADS is expressed in two groups of four bits each, ADS1 and ADS2.

4.3.8.4.2.1.2 When ADS1 = 0 and ADS2 = 5, the following subfield shall be contained in MA:

4.3.8.4.2.1.3 SLC (ACAS sensitivity level control (SLC) command). This 4-bit (41-44) subfield shall denote a sensitivity level command for own ACAS.

Coding

0	No command issued
1	Not assigned
2	Set ACAS sensitivity level to 2
3	Set ACAS sensitivity level to 3
4	Set ACAS sensitivity level to 4
5	Set ACAS sensitivity level to 5
6	Set ACAS sensitivity level to 6
7-14	Not assigned
15	Cancel previous SLC command from this ground station

Note 1.— Structure of MA for a sensitivity level control command:

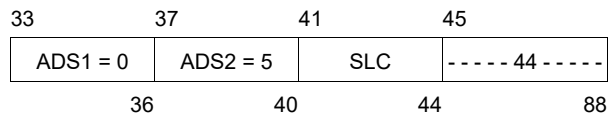

Note 2.— ACAS X-compliant systems receive SLC commands but their sensitivity level values are not used.

4.3.8.4.2.2 Subfields in MB

Note.— 4.3.8.4.2.2.1 is applicable to TCAS Version 7.1-compliant systems, while 4.3.8.4.2.2.2 is applicable to ACAS X-compliant systems. 4.3.8.4.2.2.3 is applicable to both TCAS Version 7.1- and ACAS X-compliant systems.

4.3.8.4.2.2.1 For TCAS Version 7.1-compliant systems: Subfields in MB for an RA report. When BDS1=3 and BDS2=0, the subfields indicated below shall be contained in MB.

Note.— The requirements for communication of information relating to the current or recent RAs is described in 4.3.11.4.1.

4.3.8.4.2.2.1.1 ARA (active RAs). This 14-bit (41-54) subfield shall indicate the characteristics of the RA, if any, generated by the ACAS associated with the transponder transmitting the subfield (4.3.6.2.1 a)). The bits in ARA shall have meanings determined by the value of the MTE subfield (4.3.8.4.2.2.1.4) and, for vertical RAs, the value of bit 41 of ARA. The meaning of bit 41 of ARA shall be as follows:

Coding

0	There is more than one threat and the RA is intended to provide separation below some threat(s) and above some other threat(s) or no RA has been generated (when MTE = 0)
1	Either there is only one threat or the RA is intended to provide separation in the same direction for all threats

When ARA bit 41 = 1 and MTE = 0 or 1, bits 42-47 shall have the following meanings:

<i>Bit</i>	<i>Coding</i>	
42	0	RA is preventive
	1	RA is corrective
43	0	Upward sense RA has been generated
	1	Downward sense RA has been generated
44	0	RA is not increased rate
	1	RA is increased rate
45	0	RA is not a sense reversal
	1	RA is a sense reversal
46	0	RA is not altitude crossing
	1	RA is altitude crossing
47	0	RA is vertical speed limit
	1	RA is positive
48-54		Reserved for ACAS III

When ARA bit 41 = 0 and MTE = 1, bits 42-47 shall have the following meanings:

<i>Bit</i>	<i>Coding</i>	
42	0	RA does not require a correction in the upward sense
	1	RA requires a correction in the upward sense
43	0	RA does not require a positive climb
	1	RA requires a positive climb
44	0	RA does not require a correction in the downward sense
	1	RA requires a correction in the downward sense
45	0	RA does not require a positive descend
	1	RA requires a positive descend
46	0	RA does not require a crossing
	1	RA requires a crossing
47	0	RA is not a sense reversal
	1	RA is a sense reversal
48-54		Reserved for ACAS III

Note 1.— When ARA bit 41 = 0 and MTE = 0, no vertical RA has been generated.

Note 2.— An RA is considered crossing if own aircraft is expected to cross the altitude of the intruder before closest approach, e.g. pass above a threat currently above own aircraft. An RA is considered crossing regardless of whether the word “crossing” is included in the aural annunciation.

4.3.8.4.2.2.1.2 *RAC (RACs record)*. This 4-bit (55-58) subfield shall indicate all the currently active RACs, if any, received from other ACAS aircraft. The bits in RAC shall have the following meanings:

<i>Bit</i>	<i>Resolution advisory complement</i>
55	Do not pass below
56	Do not pass above
57	Do not turn left
58	Do not turn right

A bit set to 1 shall indicate that the associated RAC is active. A bit set to 0 shall indicate that the associated RAC is inactive.

4.3.8.4.2.2.1.3 *RAT (RA terminated indicator)*. This 1-bit (59) subfield shall indicate when an RA previously generated by ACAS has ceased being generated.

Coding

- 0 ACAS is currently generating the RA indicated in the ARA subfield
- 1 The RA indicated by the ARA subfield has been terminated (4.3.11.4.1)

Note 1.— After an RA has been terminated by ACAS, it is still required to be reported by the Mode S transponder for 18 ± 1 s (4.3.11.4.1). The RA terminated indicator may be used, for example, to permit timely removal of an RA indication from an air traffic controller's display, or for assessments of RA duration within a particular airspace.

Note 2.— RAs may terminate for a number of reasons: normally, when the conflict has been resolved and the threat is diverging in range; or when the threat's Mode S transponder for some reason ceases to report altitude during the conflict. The RA terminated indicator is used to show that the RA has been removed in each of these cases.

4.3.8.4.2.2.1.4 *MTE (multiple threat encounter)*. This 1-bit (60) subfield shall indicate whether two or more simultaneous threats are currently being processed by the ACAS threat resolution logic.

Coding

- 0 One threat is being processed by the resolution logic (when ARA bit 41 = 1); or no threat is being processed by the resolution logic (when ARA bit 41 = 0)
- 1 Two or more simultaneous threats are being processed by the resolution logic

4.3.8.4.2.2.1.5 *TTI (threat type indicator subfield)*. This 2-bit subfield (61-62) shall define the type of identity data contained in the TID subfield.

Coding

- 0 No identity data in TID
- 1 TID contains a Mode S transponder address
- 2 TID contains altitude, range and bearing data
- 3 Not assigned

4.3.8.4.2.2.1.6 *TID (threat identity data subfield)*. This 26-bit subfield (63-88) shall contain the Mode S address of the threat or the altitude, range, and bearing if the threat is not Mode S equipped. If two or more threats are simultaneously processed by the ACAS resolution logic, TID shall contain the identity or position data for the most recently declared threat. If TTI = 1, TID shall contain in bits 63-86 the aircraft address of the threat, and bits 87 and 88 shall be set to 0. If TTI = 2, TID shall contain the following three subfields.

4.3.8.4.2.2.1.6.1 *TIDA (threat identity data altitude subfield)*. This 13-bit subfield (63-75) shall contain the most recently reported Mode C altitude code of the threat.

Coding

Bit	63	64	65	66	67	68	69	70	71	72	73	74	75
Mode C code bit	C ₁	A ₁	C ₂	A ₂	C ₄	A ₄	0	B ₁	D ₁	B ₂	D ₂	B ₄	D ₄

4.3.8.4.2.2.1.6.2 *TIDR (threat identity data range subfield)*. This 7-bit subfield (76-82) shall contain the most recent threat range estimated by ACAS.

Coding (n)

- n* Estimated range (NM)
- 0 No range estimate available
- 1 Less than 0.05
- 2-126 $(n-1)/10 \pm 0.05$
- 127 Greater than 12.55

4.3.8.4.2.2.1.6.3 *TIDB (threat identity data bearing subfield)*. This 6-bit subfield (83-88) shall contain the most recent estimated bearing of the threat aircraft, relative to the ACAS aircraft heading.

<i>Coding (n)</i>	
<i>n</i>	<i>Estimated bearing (degrees)</i>
0	No bearing estimate available
1-60	Between $6(n-1)$ and $6n$
61-63	Not assigned

Note.— Structure of MB for an RA report:

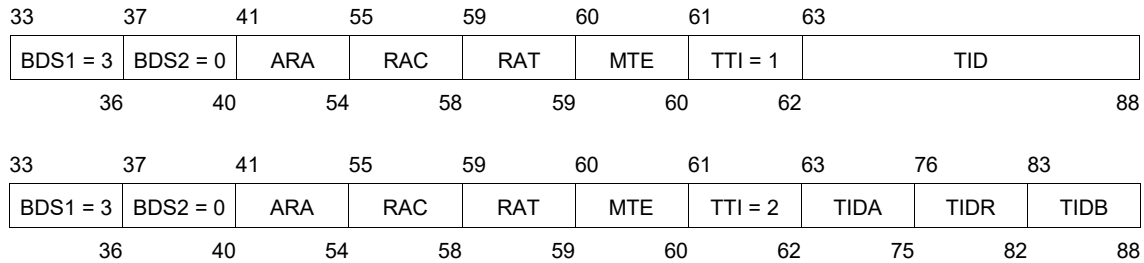

4.3.8.4.2.2.2 *For ACAS X-compliant systems: Subfields in MB for an RA report*. When BDS1=3 and BDS2=0, the subfields indicated below shall be contained in MB.

4.3.8.4.2.2.2.1 *ARA (active RAs)*. This 10-bit (41-50) subfield shall indicate the currently active RA if any generated by own ACAS X unit against one or more threat aircraft.

The ARA subfield is further divided into:

- a) *AVRA (vertical RA)*. This 7-bit (41-47) subfield contains the vertical component of the ARA as defined below; and
- b) *AHRA (horizontal RA)*. This 3-bit (48-50) subfield contains the horizontal component of the ARA. For ACAS X-compliant systems, AHRA=0.

Bits 41-50 shall have the following meanings:

<i>Bit</i>	<i>Coding</i>	
41	0	Different vertical senses have been generated in a multi-threat encounter (when MTE = 1); or no RA has been generated (when MTE=0)
	1	The same vertical sense has been generated in a single or multi-threat encounter
42	0	RA is not crossing
	1	RA is crossing
43	0	Upward sense RA has been generated (i.e. own aircraft intent is to pass above the threat)
	1	Downward sense RA has been generated (i.e. own aircraft intent is to pass below the threat)
44		Strength bit 1
45		Strength bit 2
46		Strength bit 3
47		Strength bit 4
48-50	0	AHRA

Note. — An RA is considered crossing if own aircraft is expected to cross the altitude of the intruder before closest approach, e.g., pass above a threat currently above own aircraft. An RA is considered crossing regardless of whether the word “crossing” is included in the aural annunciation.

The strength bits indicated in bits 44 - 47 shall have the following meaning:

<i>Strength bits</i>	
1 2 3 4	
0 0 0 0	0 Clear of conflict
0 0 0 1	1 Monitor vertical speed
0 0 1 0	2 Level-off; weakening of positive RA
0 0 1 1	3 Level-off; corrective when climbing/descending
0 1 0 0	4 Climb/descend at 1 500 ft/min
0 1 0 1	5 Reversal to climb/descend
0 1 1 0	6 Increase climb/descend
0 1 1 1	7 Maintain rate; at current rate > 1 500 ft/min
1 0 0 0	8 Reversal to maintain
1 0 0 1	9 Level-off; reversal to corrective negative RA
1 0 1 0	10 Monitor vertical speed; following descend RA, descend inhibited
1 0 1 1	11 Monitor vertical speed; reversal to preventive negative RA
1 1 0 0	12 Unallocated
1 1 0 1	13 Unallocated
1 1 1 0	14 Preventive multi-threat level off (MTLO) while level
1 1 1 1	15 Corrective MTLO while climbing/descending

Note. — For MTLO own aircraft with -500 ft/min to +500 ft/min is “level”; own aircraft with vertical rate > 500 ft/min is “climbing” and own aircraft with vertical rate < -500 ft/min is “descending”

4.3.8.4.2.2.2.2 *LDI (low-level descend inhibit).* This 2-bit (51-52) subfield is derived from the own aircraft radar altimeter value and shall indicate whether own aircraft is in a region where low level descend inhibits may be applied. The coding shall have the following meanings:

<i>Bits 51-52</i>	
<i>Coding</i>	
0	No descend inhibit
1	Increase descend RAs inhibited
2	Both increase descend RAs and descend RAs inhibited
3	All RAs are inhibited

4.3.8.4.2.2.2.3 *RMF (RA message format).* This 2-bit (53-54) subfield indicates the collision avoidance (CA) system used to generate bits 41-88 of the RF message. The coding shall have the following meanings:

<i>Bits 53-54</i>	
<i>Coding</i>	
0	All TCAS II versions
1	ACAS X-compliant system
2	Reserved for ACAS III
3	Unallocated

4.3.8.4.2.2.2.4 *RAC (RACs record)*. This 4-bit (55-58) subfield shall indicate all the currently active RACs, if any, received from other ACAS aircraft. The bits in RAC shall have the following meanings:

<i>Bit</i>	<i>Resolution advisory complement</i>
55	Do not pass below
56	Do not pass above
57	Reserved for horizontal coordination
58	Reserved for horizontal coordination

A bit set to 1 shall indicate that the associated RAC is active. A bit set to 0 shall indicate that the associated RAC is inactive.

4.3.8.4.2.2.2.5 *RAT (RA terminated indicator)*. This 1-bit (59) subfield shall indicate when an RA previously generated by ACAS has ceased being generated.

Coding

0	ACAS is currently generating the RA indicated in the ARA subfield
1	The RA indicated by the ARA subfield has been terminated (4.3.11.4.1)

Note 1. — After an RA has been terminated by ACAS, it is still required to be reported by the Mode S transponder for 18 ± 1 s (4.3.11.4.1). The RA terminated indicator may be used, for example, to permit timely removal of an RA indication from an air traffic controller's display, or for assessments of RA duration within a particular airspace.

Note 2. — RAs may terminate for a number of reasons: normally, when the conflict has been resolved and the threat is diverging in range; or when the threat's Mode S transponder for any reason ceases to report altitude during the conflict. The RA terminated indicator is used to show that the RA has been removed in each of these cases.

4.3.8.4.2.2.2.6 *MTE (multiple threat encounter)*. This 1-bit (60) subfield shall indicate whether two or more simultaneous threats are currently being processed by the ACAS threat resolution logic.

Coding

0	One threat is being processed by the resolution logic (when ARA bit 41 = 1); or no threat is being processed by the resolution logic (when ARA bit 41 = 0)
1	Two or more simultaneous threats are being processed by the resolution logic

4.3.8.4.2.2.2.7 *CNT (continuation bit)*. This 1-bit subfield (61) shall indicate whether a follow-on RF message is being generated to report additional information.

Coding

0	No follow-on RF message exists
1	A follow-on RF message exists

4.3.8.4.2.2.2.8 *TTI (threat type indicator subfield)*. This 1-bit subfield (62) shall define the type of identity data contained in the TID subfield.

Coding

0	TID contains altitude, range and bearing data
1	TID contains a 24-bit aircraft address

4.3.8.4.2.2.2.9 *TID (threat identity data subfield)*. This 24-bit subfield (63-86) shall contain the 24-bit aircraft address of the threat or the altitude, range, and bearing if the threat is not Mode S-equipped. If two or more threats are simultaneously processed by the ACAS resolution logic, TID shall contain the identity or position data for the most recently declared threat. If TTI = 1, TID shall contain in bits 63-86 the aircraft address of the threat. If TTI = 0, TID shall contain the following three subfields (refer to 4.3.8.4.2.2.2.8).

4.3.8.4.2.2.9.1 *TIDA (threat identity data altitude subfield)*. This 11-bit subfield (63-73) shall contain the most recent threat altitude estimated by ACAS, expressed in binary to a resolution of 100 ft as follows.

Coding

0	No data
1	Alt < -950 ft
2	-950 ft ≤ Alt < -850 ft
3	-850 ft ≤ Alt < -750 ft
4....	

4.3.8.4.2.2.9.2 *TIDR (threat identity data range subfield)*. This 7-bit subfield (74-80) shall contain the most recent threat range estimated by ACAS.

Coding (n)

<i>n</i>	<i>Estimated range (NM)</i>
0	No range estimate available
1	Less than 0.05
2-126	$(n-1)/10 \pm 0.05$
127	Greater than 12.55

4.3.8.4.2.2.9.3 *TIDB (threat identity data bearing subfield)*. This 6-bit subfield (81-86) shall contain the most recent estimated bearing of the threat aircraft, relative to the ACAS aircraft heading.

Coding (n)

<i>n</i>	<i>Estimated bearing (degrees)</i>
0	No bearing estimate available
1-60	Between $6(n-1)$ and $6n$
61-63	<i>Not assigned</i>

4.3.8.4.2.2.10 *DSI (designation indicator)*. This 1-bit subfield (87) shall be coded as follows:

Coding

0	The threat defined in TID is not designated for Xo or the designation is not applied
1	The threat defined in TID is designated for Xo, and the designation is applied

4.3.8.4.2.2.11 *SPI (suppression indicator)*. This 1-bit subfield (88) shall be coded as follows:

For single-threat encounters:

Coding

0	The RA is not suppressed
1	The RA is suppressed (not announced to the flight crew)

For multi-threat encounters, suppression does not apply, so the SPI subfield shall indicate the following designations:

Coding

0	No threat other than the one defined in TID is designated for Xo
1	Another threat is designated for Xo, and the designation is applied

Note.— For ACAS X-compliant systems: Subfields in MB for an RA report.

33	37	41	51	53	55	59	60	61	62	63	74	81	87	88
BDS1 = 3	BDS2 = 0	ARA	LDI	RMF	RAC	RAT	MTE	CNT	TTI = 0	TIDA	TIDR	TIDB	DSI	SPI
36	40	50	52	54	58	59	60	61	62	73	80	86	87	88

33	37	41	51	53	55	59	60	61	62	63			87	88
BDS1 = 3	BDS2 = 0	ARA	LDI	RMF	RAC	RAT	MTE	CNT	TTI = 1		TID		DSI	SPI
36	40	50	52	54	58	59	60	61	62			86	87	88

4.3.8.4.2.2.3 *Subfields in MB for the data link capability report.* When BDS1 = 1 and BDS2 = 0, the following bit patterns shall be provided to the transponder for its data link capability report:

Bit Coding

43-46	0000	TCAS Version 7.1-compliant and other systems defined by bits 71 and 72
	0001	ACAS Xa (RTCA/DO-385 and EUROCAE/ED-256)
	0010 to	
	1111	Reserved for ACAS III
48	0	ACAS failed or on standby
	1	ACAS operating
69	0	Hybrid surveillance not operational
	1	Hybrid surveillance fitted and operational
70	0	ACAS generating TAs only
	1	ACAS generating TAs and RAs
Bit 72	Bit 71	ACAS version
0	0	RTCA/DO-185 (pre-ACAS)
0	1	RTCA/DO-185A
1	0	RTCA/DO-185B and EUROCAE ED 143
1	1	All later systems (see <i>Note 3</i> and 4.3.8.4.2.8)

Note 1.— A summary of the MB subfields for the data link capability report structure is described in Chapter 3, 3.1.2.6.10.2.2.

Note 2.— The use of hybrid surveillance to limit ACAS active interrogations is described in 4.5.1. The ability only to support decoding of DF = 17 extended squitter messages is not sufficient to set bit 69.

Note 3.— Future versions of ACAS will be identified using part numbers and software version numbers specified in registers E5₁₆ and E6₁₆.

4.3.8.4.2.3 *MU field.* This 56-bit (33-88) field of long air-air surveillance interrogations (Figure 4-1) shall be used to transmit resolution messages, ACAS broadcasts and RA broadcasts.

4.3.8.4.2.3.1 *UDS (U-definition subfield).* This 8-bit (33-40) subfield shall define the remainder of MU.

Note.— For convenience in coding, UDS is expressed in two groups of four bits each, UDS1 and UDS2.

4.3.8.4.2.3.2 *Subfields in MU for a resolution message.* When UDS1 = 3 and UDS2 = 0 the following subfields shall be contained in MU:

4.3.8.4.2.3.2.1 *MTB (multiple threat bit)*. This 1-bit (42) subfield shall indicate the presence or absence of multiple threats.

Coding

- 0 Interrogating ACAS has not more than one threat
- 1 Interrogating ACAS has more than one threat

4.3.8.4.2.3.2.2 *VRC (vertical RAC)*. This 2-bit (45-46) subfield shall denote a vertical RAC relating to the addressed aircraft.

Coding

- 0 No vertical RAC sent
- 1 Do not pass below
- 2 Do not pass above
- 3 Not assigned

4.3.8.4.2.3.2.3 *CVC (cancel vertical RAC)*. This 2-bit (43-44) subfield shall denote the cancellation of a vertical RAC previously sent to the addressed aircraft. This subfield shall be set to 0 for a new threat.

Coding

- 0 No cancellation
- 1 Cancel previously sent “Do not pass below”
- 2 Cancel previously sent “Do not pass above”
- 3 Not assigned

4.3.8.4.2.3.2.4 *HRC (horizontal RAC)*. This 3-bit (50-52) subfield shall denote a horizontal RAC relating to the addressed aircraft.

Coding

- 0 No horizontal RAC or no horizontal resolution capability
- 1 Other ACAS sense is turn left; do not turn left
- 2 Other ACAS sense is turn left; do not turn right
- 3 Not assigned
- 4 Not assigned
- 5 Other ACAS sense is turn right; do not turn left
- 6 Other ACAS sense is turn right; do not turn right
- 7 Not assigned

4.3.8.4.2.3.2.5 *CHC (cancel horizontal RAC)*. This 3-bit (47-49) subfield shall denote the cancellation of a horizontal RAC previously sent to the addressed aircraft. This subfield shall be set to 0 for a new threat.

Coding

- 0 No cancellation or no horizontal resolution capability
- 1 Cancel previously sent “Do not turn left”
- 2 Cancel previously sent “Do not turn right”
- 3-7 Not assigned

4.3.8.4.2.3.2.6 *VSB (vertical sense bits subfield)*. This 4-bit (61-64) subfield shall be used to protect the data in the CVC and VRC subfields. For each of the 16 possible combinations of bits 43-46 the following VSB code shall be transmitted:

Coding	CVC		VRC		VSB			
	43	44	45	46	61	62	63	64
0	0	0	0	0	0	0	0	0
1	0	0	0	1	1	1	1	0
2	0	0	1	0	0	1	1	1
3	0	0	1	1	1	0	0	1
4	0	1	0	0	1	0	1	1
5	0	1	0	1	0	1	0	1
6	0	1	1	0	1	1	0	0
7	0	1	1	1	0	0	1	0
8	1	0	0	0	1	1	0	1
9	1	0	0	1	0	0	1	1
10	1	0	1	0	1	0	1	0
11	1	0	1	1	0	1	0	0
12	1	1	0	0	0	1	1	0
13	1	1	0	1	1	0	0	0
14	1	1	1	0	0	0	0	1
15	1	1	1	1	1	1	1	1

Note.— The rule used to generate the VSB subfield bit setting is a distance 3 Hamming code augmented with a parity bit, producing the ability to detect up to three errors in the eight transmitted bits.

4.3.8.4.2.3.2.7 *HSB (horizontal sense bits subfield)*. This 5-bit (56-60) subfield shall be used to protect the data in the CHC and HRC subfields. For each of the 64 possible combinations of bits 47-52 the following HSB code shall be transmitted:

Coding	CHC			HRC			HSB				
	47	48	49	50	51	52	56	57	58	59	60
0	0	0	0	0	0	0	0	0	0	0	0
1	0	0	0	0	0	1	0	1	0	1	1
2	0	0	0	0	1	0	1	0	0	1	1
3	0	0	0	0	1	1	1	1	1	0	0
4	0	0	0	1	0	0	1	1	1	1	0
5	0	0	0	1	0	1	1	0	1	1	1
6	0	0	0	1	1	0	0	1	1	1	1
7	0	0	0	1	1	1	0	0	1	0	0
8	0	0	1	0	0	0	0	1	1	0	1
9	0	0	1	0	0	1	0	0	1	1	0
10	0	0	1	0	1	0	1	1	1	1	0
11	0	0	1	0	1	1	1	0	1	0	1
12	0	0	1	1	0	0	1	0	0	0	1
13	0	0	1	1	0	1	1	1	0	1	0
14	0	0	1	1	1	0	0	0	0	1	0
15	0	0	1	1	1	1	0	1	0	0	1
16	0	1	0	0	0	0	1	0	1	0	1
17	0	1	0	0	0	1	1	1	1	1	0
18	0	1	0	0	1	0	0	0	1	1	0
19	0	1	0	0	1	1	0	1	1	0	1
20	0	1	0	1	0	0	0	1	0	0	1
21	0	1	0	1	0	1	0	0	0	1	0

Coding	CHC				HRC			HSB				
	47	48	49	50	51	52	56	57	58	59	60	
22	0	1	0	1	1	0	1	1	0	1	0	
23	0	1	0	1	1	1	1	0	0	0	1	
24	0	1	1	0	0	0	1	1	0	0	0	
25	0	1	1	0	0	1	1	0	0	1	1	
26	0	1	1	0	1	0	0	1	0	1	1	
27	0	1	1	0	1	1	0	0	0	0	0	
28	0	1	1	1	0	0	0	0	1	0	0	
29	0	1	1	1	0	1	0	1	1	1	1	
30	0	1	1	1	1	0	1	0	1	1	1	
31	0	1	1	1	1	1	1	1	1	0	0	
32	1	0	0	0	0	0	1	1	0	0	1	
33	1	0	0	0	0	1	1	0	0	1	0	
34	1	0	0	0	1	0	0	1	0	1	0	
35	1	0	0	0	1	1	0	0	0	0	1	
36	1	0	0	1	0	0	0	0	1	0	1	
37	1	0	0	1	0	1	0	1	1	1	0	
38	1	0	0	1	1	0	1	0	1	1	0	
39	1	0	0	1	1	1	1	1	1	0	1	
40	1	0	1	0	0	0	1	0	1	0	0	
41	1	0	1	0	0	1	1	1	1	1	1	
42	1	0	1	0	1	0	0	0	1	1	1	
43	1	0	1	0	1	1	0	1	1	0	0	
44	1	0	1	1	0	0	0	1	0	0	0	
45	1	0	1	1	0	1	0	0	0	1	1	
46	1	0	1	1	1	0	1	1	0	1	1	
47	1	0	1	1	1	1	1	0	0	0	0	
48	1	1	0	0	0	0	0	1	1	0	0	
49	1	1	0	0	0	1	0	0	1	1	1	
50	1	1	0	0	1	0	1	1	1	1	1	
51	1	1	0	0	1	1	1	0	1	0	0	
52	1	1	0	1	0	0	1	0	0	0	0	
53	1	1	0	1	0	1	1	1	0	1	1	
54	1	1	0	1	1	0	0	0	0	1	1	
55	1	1	0	1	1	1	0	1	0	0	0	
56	1	1	1	0	0	0	0	0	0	0	1	
57	1	1	1	0	0	1	0	1	0	1	0	
58	1	1	1	0	1	0	1	0	0	1	0	
59	1	1	1	0	1	1	1	1	0	0	1	
60	1	1	1	1	0	0	1	1	1	0	1	
61	1	1	1	1	0	1	1	0	1	1	0	
62	1	1	1	1	1	0	0	1	1	1	0	
63	1	1	1	1	1	1	0	0	1	0	1	

Note.— The rule used to generate the HSB subfield bit setting is a distance 3 Hamming code augmented with a parity bit, producing the ability to detect up to three errors in the eleven transmitted bits.

4.3.8.4.2.3.2.8 *MID (Aircraft address).* This 24-bit (65-88) subfield shall contain the 24-bit aircraft address of the interrogating ACAS aircraft.

Note.— Structure of MU for a resolution message:

33	37	41	42	43	45	47	50	53	56	61	65
UDS1 = 3	UDS2 = 0	-1-	MTB	CVC	VRC	CHC	HRC	-3-	HSB	VSB	MID
36	40	41	42	44	46	49	52	55	60	64	88

4.3.8.4.2.3.3 *Subfield in MU for an ACAS broadcast.* When UDS1 = 3 and UDS2 = 2, the following subfield shall be contained in MU:

4.3.8.4.2.3.3.1 *MID (Aircraft address).* This 24-bit (65-88) subfield shall contain the 24-bit aircraft address of the interrogating ACAS aircraft.

Note.— Structure of MU for an ACAS broadcast:

33	37	41	65
UDS1 = 3	UDS2 = 2	-----24-----	MID
36	40	64	88

4.3.8.4.2.3.4 *Subfields in MU for an RA broadcast (RA broadcast interrogation message)*

Note. — 4.3.8.4.2.3.4.1 is only applicable to TCAS Version 7.1-compliant systems, while 4.3.8.4.2.3.4.2 is only applicable to ACAS X-compliant systems

4.3.8.4.2.3.4.1 *For TCAS Version 7.1-compliant systems: Subfields in MU for an RA broadcast (RA broadcast interrogation message).* When UDS1 = 3 and UDS2 = 1, the following subfields shall be contained in MU:

4.3.8.4.2.3.4.1.1 *ARA (active RAs).* This 14-bit (41-54) subfield shall be coded as defined in 4.3.8.4.2.2.1.1.

4.3.8.4.2.3.4.1.2 *RAC (RACs record).* This 4-bit (55-58) subfield shall be coded as defined in 4.3.8.4.2.2.1.2.

4.3.8.4.2.3.4.1.3 *RAT (RA terminated indicator).* This 1-bit (59) subfield shall be coded as defined in 4.3.8.4.2.2.1.3.

4.3.8.4.2.3.4.1.4 *MTE (multiple threat encounter).* This 1-bit (60) subfield shall be coded as defined in 4.3.8.4.2.2.1.4.

4.3.8.4.2.3.4.1.5 *AID (Mode A identity code).* This 13-bit (63-75) subfield shall denote the Mode A identity code of the reporting aircraft.

Coding

Bit	63	64	65	66	67	68	69	70	71	72	73	74	75
Mode A code bit	A ₄	A ₂	A ₁	B ₄	B ₂	B ₁	0	C ₄	C ₂	C ₁	D ₄	D ₂	D ₁

4.3.8.4.2.3.4.1.6 *CAC (Mode C altitude code).* This 13-bit (76-88) subfield shall denote the Mode C altitude code of the reporting aircraft.

Coding

Bit	76	77	78	79	80	81	82	83	84	85	86	87	88
Mode C code bit	C ₁	A ₁	C ₂	A ₂	C ₄	A ₄	0	B ₁	D ₁	B ₂	D ₂	B ₄	D ₄

Note.— Structure of MU for an RA broadcast:

33	37	41	55	59	60	61	63	76
UDS1 = 3	UDS2 = 1	ARA	RAC	RAT	MTE	-2-	AID	CAC
36	40	54	58	59	60	62	75	88

4.3.8.4.2.3.4.2 For ACAS X-compliant systems: Subfields in MU for an RA broadcast (RA broadcast interrogation message). When UDS1 = 3 and UDS2 = 1, the following subfields shall be contained in MU:

4.3.8.4.2.3.4.2.1 ARA (active RAs). This 10-bit (41-50) subfield shall be coded as defined in 4.3.8.4.2.2.2.1.

4.3.8.4.2.3.4.2.2 LDI (low-level descend inhibit). This 2-bit (51-52) subfield shall be coded as defined in 4.3.8.4.2.2.2.2.

4.3.8.4.2.3.4.2.3 RMF (RA message format). This 2-bit (53-54) subfield shall be coded as defined in 4.3.8.4.2.2.2.3.

4.3.8.4.2.3.4.2.4 RAC (RACs record). This 4-bit (55-58) subfield shall be coded as defined in 4.3.8.4.2.2.2.4.

4.3.8.4.2.3.4.2.5 RAT (RA terminated indicator). This 1-bit (59) subfield shall be coded as defined in 4.3.8.4.2.2.2.5.

4.3.8.4.2.3.4.2.6 MTE (multiple threat encounter). This 1-bit (60) subfield shall be coded as defined in 4.3.8.4.2.2.2.6.

4.3.8.4.2.3.4.2.7 SPI (Suppression indicator). This 1-bit (61) subfield shall be coded as defined in 4.3.8.4.2.2.2.11.

4.3.8.4.2.3.4.2.8 AID (Mode A identity code). This 13-bit (63-75) subfield shall denote the Mode A identity code of the reporting aircraft.

Coding

Bit	63	64	65	66	67	68	69	70	71	72	73	74	75
Mode A code bit	A ₄	A ₂	A ₁	B ₄	B ₂	B ₁	0	C ₄	C ₂	C ₁	D ₄	D ₂	D ₁

4.3.8.4.2.3.4.2.9 CAC (Mode C altitude code). This 13-bit (76-88) subfield shall denote the Mode C altitude code of the reporting aircraft.

Coding

Bit	76	77	78	79	80	81	82	83	84	85	86	87	88
Mode C code bit	C ₁	A ₁	C ₂	A ₂	C ₄	A ₄	0	B ₁	D ₁	B ₂	D ₂	B ₄	D ₄

Note.— Structure of MU for an RA broadcast:

33	37	41	51	53	55	59	60	61	62	63	76
UDS1 = 3	UDS2 = 1	ARA	LDI	RMF	RAC	RAT	MTE	SPI	-1-	AID	CAC
36	40	50	52	54	58	59	60	61	62	75	88

4.3.8.4.2.4 MV field. This 56-bit (33-88) field of long air-air surveillance replies (Figure 4-1) shall be used to transmit air-air coordination reply messages.

4.3.8.4.2.4.1 VDS (V-definition subfield). This 8-bit (33-40) subfield shall define the remainder of MV.

Note.— For convenience in coding, VDS is expressed in two groups of four bits each, VDS1 and VDS2.

4.3.8.4.2.4.2 Subfields in MV for a coordination reply

Note. — 4.3.8.4.2.4.2.1 is only applicable to TCAS Version 7.1-compliant systems, while 4.3.8.4.2.4.2.2 is only applicable to ACAS X-compliant systems.

4.3.8.4.2.4.2.1 For TCAS Version 7.1-compliant systems: Subfields in MV for a coordination reply. When VDS1 = 3 and VDS2 = 0, the following subfields shall be contained in MV:

4.3.8.4.2.4.2.1.1 ARA (active RAs). This 14-bit (41-54) subfield shall be coded as defined in 4.3.8.4.2.2.1.1.

4.3.8.4.2.4.2.1.2 RAC (RACs record). This 4-bit (55-58) subfield shall be coded as defined in 4.3.8.4.2.2.1.2.

4.3.8.4.2.4.2.1.3 RAT (RA terminated indicator). This 1-bit (59) subfield shall be coded as defined in 4.3.8.4.2.2.1.3.

4.3.8.4.2.4.2.1.4 MTE (multiple threat encounter). This 1-bit (60) subfield shall be coded as defined in 4.3.8.4.2.2.1.4.

Note.— Structure of MV for a coordination reply:

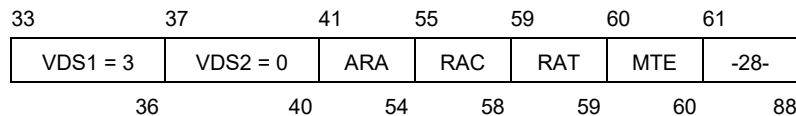

4.3.8.4.2.4.2.2 For ACAS X-compliant systems: Subfields in MV for a coordination reply. When VDS1 = 3 and VDS2 = 0, the following subfields shall be contained in MV:

4.3.8.4.2.4.2.2.1 ARA (active RAs). This 10-bit (41-50) subfield shall be coded as defined in 4.3.8.4.2.2.2.1.

4.3.8.4.2.4.2.2.2 LDI (low-level descend inhibit). This 2-bit (51-52) subfield shall be coded as defined in 4.3.8.4.2.2.2.2.

4.3.8.4.2.4.2.2.3 RMF (RA message format). This 2-bit (53-54) subfield shall be coded as defined in 4.3.8.4.2.2.2.3.

4.3.8.4.2.4.2.2.4 RAC (RACs record). This 4-bit (55-58) subfield shall be coded as defined in 4.3.8.4.2.2.2.4.

4.3.8.4.2.4.2.2.5 RAT (RA terminated indicator). This 1-bit (59) subfield shall be coded as defined in 4.3.8.4.2.2.2.5.

4.3.8.4.2.4.2.2.6 MTE (multiple threat encounter). This 1-bit (60) subfield shall be coded as defined in 4.3.8.4.2.2.2.6.

Note. — Structure of MV for a coordination reply:

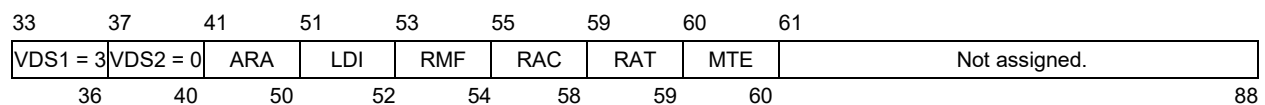

4.3.8.4.2.5 SL (sensitivity level report). This 3-bit (9-11) downlink field shall be included in both short and long air-air reply formats (DF = 0 and 16). This field shall denote the sensitivity level at which ACAS is currently operating.

Coding

0	ACAS inoperative
1	ACAS is operating at sensitivity level 1
2	ACAS is operating at sensitivity level 2
3	ACAS is operating at sensitivity level 3
4	ACAS is operating at sensitivity level 4
5	ACAS is operating at sensitivity level 5
6	ACAS is operating at sensitivity level 6
7	ACAS is operating at sensitivity level 7

Note. — For ACAS X-compliant systems: ACAS will not transmit an SL code greater than 3.

4.3.8.4.2.6 *CC: Cross-link capability.* This 1-bit (7) downlink field shall indicate the ability of the transponder to support the cross-link capability, i.e. decode the contents of the DS field in an interrogation with UF equals 0 and respond with the contents of the specified GICB register in the corresponding reply with DF equals 16.

Coding

0	signifies that the transponder cannot support the cross-link capability.
1	signifies that the transponder supports the cross-link capability.

4.3.8.4.2.7 *For ACAS X-compliant systems: Extended squitter ME field for use in air-to-air coordination.* This 56-bit (33-88) field shall be used for air-to-air coordination involving ADS-B-only equipped intruders (intruders that cannot receive a discrete 1 030 MHz resolution message).

Note. — ADS-B messages with TYPE code = 28 (ADS-B operational coordination message, refer to 4.3.8.4.2.7.1) and TYPE code = 31 (ADS-B aircraft operational status message, refer to 4.3.8.4.2.7.2) are used in air-to-air coordination.

4.3.8.4.2.7.1 *Subfields in ME for ADS-B operational coordination message (OCM).*

Note. — In the subfields defined below, the bit number is relative to the start of the extended squitter, where bit 33 is the start of the ME message field.

4.3.8.4.2.7.1.1 *TYPE.* This 5-bit (33-37) subfield that defines the type of extended squitter shall be set to 28 for the ADS-B OCM.

4.3.8.4.2.7.1.2 *Subtype.* This 3-bit (38-40) subfield that further defines TYPE shall be set to 3 for the ADS-B OCM.

4.3.8.4.2.7.1.3 *MTB (multiple threat bit).* This 1-bit (42) subfield shall indicate a multiple threat according to the codes as defined in 4.3.8.4.2.3.

4.3.8.4.2.7.1.4 *CVC (cancel vertical RAC).* This 2-bit (43-44) subfield shall be used by airborne ACAS X equipment to cancel a vertical resolution advisory complement sent to an ACAS-equipped threat aircraft with codes as defined in 4.3.8.4.2.3.

4.3.8.4.2.7.1.5 *VRC (vertical RAC).* This 2-bit (45-46) subfield shall be used by airborne ACAS X equipment to send a vertical resolution advisory complement (“do not pass above” or “do not pass below”) to an ACAS-equipped threat aircraft with codes as defined in 4.3.8.4.2.3.

4.3.8.4.2.7.1.6 *CHC (cancel horizontal RAC).* This 3-bit (47-49) subfield shall be used by ACAS X with horizontal on-board resolution equipment to cancel a horizontal resolution advisory complement sent to an ACAS-equipped threat aircraft with codes as defined in 4.3.8.4.2.3. The CHC shall be set to 0 in TCAS resolution messages transmitted by ACAS X without horizontal resolution capability.

4.3.8.4.2.7.1.7 *HRC (horizontal RAC)*. This 3-bit (50-52) subfield shall be used by ACAS X with horizontal on-board resolution equipment to send a horizontal resolution advisory complement to manoeuvre (“do not turn left” or “do not turn right”) to the ACAS-equipped threat aircraft with codes as defined in 4.3.8.4.2.3. The HRC shall be set to 0 in ADS-B OCMs transmitted by ACAS X without horizontal resolution capability.

4.3.8.4.2.7.1.8 *HSB (horizontal sense bits subfield)*. This 5-bit (53-57) subfield shall be used as a parity coding field to protect the six horizontal sense bits (47-52). The originating aircraft equipped with ACAS which is capable of 1 030/1 090 MHz transmission and that sends a coordination message shall include bits 53-57 with codes as defined in 4.3.8.4.2.3 in all ADS-B OCMs sent. The receiving ACAS X aircraft shall examine HSB (bits 53-57) in the ADS-B OCMs. If the six vertical sense bits (47-52) are not in agreement with the HSB (bits 53-57), the receiving ACAS X aircraft detects there is an error in the message and shall not use the message contents.

4.3.8.4.2.7.1.9 *VSB (vertical sense bits subfield)*. This 4-bit (58-61) subfield shall be used as a parity coding field to protect the four vertical sense bits (43-46). The originating active ACAS shall include VSB (bits 58-61) with codes as defined in 4.3.8.4.2.3 in all operational coordination messages sent. The receiving ACAS X shall examine VSB (bits 58-61) in operational coordination messages received. If four vertical sense bits (43-46) are not in agreement with VSB (bits 58-61), the receiving ACAS X aircraft detects there is an error in the message and shall not use the message contents.

4.3.8.4.2.7.1.10 *TAA (threat identity aircraft address)*. This 24-bit (65-88) subfield shall contain the 24-bit aircraft address of the threat with codes as defined in 4.3.8.4.2.3.

Note. —The structure of ME for an operational coordination message is:

<u>Position</u>	<u># of bits</u>	<u>Subfield</u>	<u>Remarks</u>
33-37	5	TYPE	= 28
38-40	3	Subtype	= 3
41	1	-	Not assigned
42	1	MTB	-
43-44	2	CVC	-
45-46	2	VRC	-
47-49	3	CHC	-
50-52	3	HRC	-
53-57	5	HSB	-
58-61	4	VSB	-
62-64	3	-	Not assigned
65-88	24	TAA	-

4.3.8.4.2.7.2 *Subfields in ME for aircraft operational status message.*

Note. — In the subfields defined below, the bit number is relative to the start of the extended squitter, where bit 33 is the start of the ME message field.

4.3.8.4.2.7.2.1 *TYPE*. This 5-bit (33-37) subfield that defines the type of extended squitter shall be set to 31 for the Aircraft operational status message.

4.3.8.4.2.7.2.2 *Subtype*. This 3-bit (38-40) subfield that further defines TYPE shall be set to 0 for airborne aircraft and 1 for surface aircraft. For ACAS X air-to-air coordination purposes, Subtype shall always be set to 0.

4.3.8.4.2.7.2.3 *CC (airborne capability class code)*. This 16-bit (41-56) subfield which is part of Subtype=0 messages shall be coded as defined in 4.3.8.4.2.7.2.3.1 to 4.3.8.4.2.7.2.3.4.

4.3.8.4.2.7.2.3.1 *Bit (41-42)*. This 2-bit (41-42) subfield shall be set to 0 for ACAS air-to-air coordination purposes.

4.3.8.4.2.7.2.3.2 *CA Operational (collision avoidance operational)*. This 1-bit (43) subfield shall be set to 1 to indicate that a collision avoidance system is available and operational and capable of issuing resolution advisories. When this bit is set to 1, the collision avoidance coordination capability bits shall be examined to provide detailed coordination information.

Note. — For all TCAS II versions and ACAS X-compliant systems, the associated Mode S transponder sets the CA Operational bit=1 when RI=3 or 4.

4.3.8.4.2.7.2.3.3 Bits (44-54) shall not be used by the ACAS X air-to-air coordination process but are reserved for future use.

4.3.8.4.2.7.2.3.4 *DAA (detect and avoid)*. This 2-bit (55-56) subfield shall be used as defined below:

00	No DAA capability or no capability of DAA system to receive CA coordination information
01	Aircraft has a DAA system capable of receiving TCAS resolution messages and ADS-B OCMs
10	Aircraft has a DAA system capable of receiving only ADS-B OCMs
11	Not defined

Note 1. — The DAA bits indicate whether and what type of coordination information needs to be provided to the aircraft so that the DAA system of the threat aircraft can listen and provide guidance that is interoperable with ACAS. These bits are independent of the CA Coordination capability bits, as aircraft with a DAA system may or may not have an ACAS. For more details of DAA bits, refer to RTCA/DO-365.

Note 2. — The type of coordination message transmitted, resolution message or ADS-B OCM, depends both on the receive capability of the DAA system and on the transmit capability of the ACAS. If the DAA system can receive both the resolution message and the OCM, an ACAS with 1 030 MHz transmit capability is required to transmit the resolution message.

4.3.8.4.2.7.2.4 *OM (airborne operational mode)*. This 16-bit (57-72) subfield which is part of Subtype=0 messages shall be coded as defined in 4.3.8.4.2.7.2.4.1 to 4.3.8.4.2.7.2.4.3.

4.3.8.4.2.7.2.4.1 *Bits (57-58)*. This 2-bit (57-58) subfield shall be set to 0 for ACAS X air-to-air coordination purposes.

4.3.8.4.2.7.2.4.2 *Bits (59-64) and Bit 72*. The bits (59-64) and bit 72 shall not be used by the ACAS X air-to-air coordination process.

4.3.8.4.2.7.2.4.3 *CCCB (collision avoidance coordination capability bits)*. This 7-bit (65-71) subfield shall be used as defined below:

Vertical and horizontal (2 bits (65-66))

00	Vertical
01	Horizontal
10	Blended
11	Reserved

Aircraft CAS Type / Capability (3 bits (67-69))

000	Active ACAS (TCAS II)
001	Active ACAS (except all TCAS II)

010	Active ACAS (except all TCAS II) with OCM transmit capability
011	Responsive ACAS
100	Passive ACAS with 1 030 MHz resolution message receive capability
101	Passive ACAS with only OCM receive capability
110 to 111	Reserved
Reserved (2 bits (70-71))	
00 to 11	Intended for unmanned aircraft systems use

Note. — The two reserved bits marked ‘Intended for unmanned aircraft systems use’ are envisioned as a priority field to distinguish among users with different levels of capability or as directed by regulatory authorities.

4.3.8.4.2.8 *ACAS unit part number and ACAS software part number.* If the ACAS and associated transponder have the necessary capacity, ACAS shall transmit its unit part number to transponder register E5₁₆ and shall transmit its software part number to transponder register E6₁₆.

Note. — The data formats for transponder registers E5₁₆ and E6₁₆ are specified in the Technical Provisions for Mode S Services and Extended Squitter (Doc 9871).

4.3.9 ACAS equipment characteristics

4.3.9.1 *Interfaces.* As a minimum, the following input data shall be provided to the ACAS:

- a) aircraft address code;
- b) air-air and ground-air Mode S transmissions received by the Mode S transponder for use by ACAS (4.3.6.3.2);
- c) own aircraft’s maximum cruising true airspeed capability (Chapter 3, 3.1.2.8.2.2);
- d) pressure-altitude;
- e) radio altitude;
- f) operating mode control (standby, TA only and TA/RA Mode);
- g) for ACAS X-compliant systems: heading;
- h) for ACAS X-compliant systems: GNSS own aircraft’s position and velocity;
- i) for ACAS X-compliant systems: ADS-B airborne and surface position, airborne velocity, target state and status, and aircraft operational status messages from other aircraft for use by ACAS; and
- j) for ACAS X-compliant systems with Xo special modes available: Designation information for special operation mode.

Note.— Specific requirements for additional inputs for ACAS II and III are listed in the appropriate sections below.

4.3.9.2 *Aircraft antenna system.* ACAS shall transmit interrogations and receive replies via two antennas, one mounted on the top of the aircraft and the other on the bottom of the aircraft. The top-mounted antenna shall be directional and capable of being used for direction finding.

4.3.9.2.1 *Polarization.* Polarization of ACAS transmissions shall be nominally vertical.

4.3.9.2.2 *Radiation pattern.* The radiation pattern in elevation of each antenna when installed on an aircraft shall be nominally equivalent to that of a quarter-wave monopole on a ground plane.

4.3.9.2.3 *ANTENNA SELECTION*

4.3.9.2.3.1 *Squitter reception.* ACAS shall be capable of receiving squitters via the top and bottom antennas.

4.3.9.2.3.2 *Interrogations.* ACAS interrogations shall not be transmitted simultaneously on both antennas.

4.3.9.3 *Pressure-altitude source.* The altitude data for own aircraft provided to ACAS shall be obtained from the source that provides the basis for own Mode C or Mode S reports and they shall be provided at the finest quantization available.

4.3.9.3.1 **Recommendation.**— *A source providing a resolution finer than 7.62 m (25 ft) should be used.*

4.3.9.3.2 Where a source providing a resolution finer than 7.62 m (25 ft) is not available, and the only altitude data available for own aircraft is Gilham encoded, at least two independent sources shall be used and compared continuously in order to detect encoding errors.

4.3.9.3.3 **Recommendation.**— *Two altitude data sources should be used and compared in order to detect errors before provision to ACAS.*

4.3.9.3.4 The provisions of 4.3.10.3 shall apply when the comparison of the two altitude data sources indicates that one of the sources is in error.

4.3.10 Monitoring

4.3.10.1 *Monitoring function.* ACAS shall continuously perform a monitoring function in order to provide a warning if any of the following conditions at least are satisfied:

- a) there is no interrogation power limiting due to interference control (4.3.2.2.2) and the maximum radiated power is reduced to less than that necessary to satisfy the surveillance requirements specified in 4.3.2; or
- b) any other failure in the equipment is detected which results in a reduced capability of providing TAs or RAs; or
- c) data from external sources indispensable for ACAS operation are not provided, or the data provided are not credible.

4.3.10.2 *Effect on ACAS operation.* The ACAS monitoring function shall not adversely affect other ACAS functions.

4.3.10.3 *Monitoring response.* When the monitoring function detects a failure (4.3.10.1), ACAS shall:

- a) indicate to the flight crew that an abnormal condition exists;
- b) prevent any further ACAS interrogations; and

- c) cause any Mode S transmission containing own aircraft's resolution capability to indicate that ACAS is not operating.

4.3.11 Requirements for a Mode S transponder used in conjunction with ACAS

4.3.11.1 *Transponder capabilities.* In addition to the minimum transponder capabilities defined in Chapter 3, 3.1, the Mode S transponder used in conjunction with ACAS shall have the following capabilities:

- a) ability to handle the following formats:

<i>Format No.</i>	<i>Format name</i>
UF = 16	Long air-air surveillance interrogation
DF = 16	Long air-air surveillance reply

- b) ability to receive long Mode S interrogations (UF = 16) and generate replies as per 3.1.2.10.3.7.3;
- c) means for delivering the ACAS data content of all accepted interrogations addressed to the ACAS equipment;
- d) antenna diversity (as specified in Chapter 3, 3.1.2.10.4);
- e) mutual suppression capability; and
- f) inactive state transponder output power restriction.

When the Mode S transponder transmitter is in the inactive state, the peak pulse power at 1 090 MHz \pm 3 MHz at the terminals of the Mode S transponder antenna shall not exceed -70 dBm.

4.3.11.2 DATA TRANSFER BETWEEN ACAS AND ITS MODE S TRANSPONDER

4.3.11.2.1 Data transfer from ACAS to its Mode S transponder:

- a) The Mode S transponder shall receive from its ACAS RA information for transmission in an RA report (4.3.8.4.2.2.1) and in a coordination reply (4.3.8.4.2.4.2);
- b) the Mode S transponder shall receive from its ACAS current sensitivity level for transmission in a sensitivity level report (4.3.8.4.2.5);
- c) the Mode S transponder shall receive from its ACAS capability information for transmission in a data link capability report (4.3.8.4.2.2.3) and for transmission in the RI field of air-air downlink formats DF = 0 and DF = 16 (4.3.8.4.1.2); and
- d) the Mode S transponder shall receive from its ACAS an indication that RAs are enabled or inhibited for transmission in the RI field of downlink formats 0 and 16.

4.3.11.2.2 Data transfer from Mode S transponder to its ACAS:

- a) For TCAS Version 7.1-compliant systems: The Mode S transponder shall transfer to its ACAS received sensitivity level control commands (4.3.8.4.2.1.1) transmitted by Mode S stations;
- b) the Mode S transponder shall transfer to its ACAS received ACAS broadcast messages (4.3.8.4.2.3.3) transmitted by other ACASs;

- c) the Mode S transponder shall transfer to its ACAS received resolution messages (4.3.8.4.2.3.2) transmitted by other ACASs for air-air coordination purposes; and
- d) the Mode S transponder shall transfer to its ACAS own aircraft's Mode A identity data for transmission in an RA broadcast (4.3.8.4.2.3.4).

4.3.11.3 COMMUNICATION OF ACAS INFORMATION TO OTHER ACAS

4.3.11.3.1 *Surveillance reply.* The ACAS Mode S transponder shall use the short (DF = 0) or long (DF = 16) surveillance formats for replies to ACAS surveillance interrogations. The surveillance reply shall include the VS field as specified in Chapter 3, 3.1.2.8.2, the RI field as specified in Chapter 3, 3.1.2.8.2 and in 4.3.8.4.1.2, and the SL field as specified in 4.3.8.4.2.5.

4.3.11.3.2 *Coordination reply.* The ACAS Mode S transponder shall transmit a coordination reply upon receipt of a coordination interrogation from an equipped threat subject to the conditions of 4.3.11.3.2.1. The coordination reply shall use the long air-air surveillance reply format, DF = 16, with the VS field as specified in Chapter 3, 3.1.2.8.2, the RI field as specified in Chapter 3, 3.1.2.8.2 and in 4.3.8.4.1.2, the SL field as specified in 4.3.8.4.2.5 and the MV field as specified in 4.3.8.4.2.4.

4.3.11.3.2.1 The ACAS Mode S transponder shall reply with a coordination reply to a coordination interrogation received from another ACAS if and only if the transponder is able to deliver the ACAS data content of the interrogation to its associated ACAS.

4.3.11.4 COMMUNICATION OF ACAS INFORMATION TO GROUND STATIONS

4.3.11.4.1 *RA reports to Mode S ground stations.* During the period of an RA and for 18 ± 1 s following the end of the RA, the ACAS Mode S transponder shall indicate that it has an RA report by setting the appropriate DR field code in replies to a Mode S sensor as specified in 4.3.8.4.1.1. The RA report shall include the MB field as specified in 4.3.8.4.2.2.1. The RA report shall describe the most recent RA that existed during the preceding 18 ± 1 s period.

Note 1.— The last sentence of 4.3.11.4.1 means that for 18 ± 1 s following the end of an RA, all MB subfields in the RA report with the exception of bit 59 (RA terminated indicator) will retain the information reported at the time the RA was last active.

Note 2.— Upon receipt of a reply with DR = 2, 3, 6 or 7, a Mode S ground station may request downlink of the RA report by setting RR = 19 and either DI = 7, or DI = 7 and RRS = 0 in a surveillance or Comm-A interrogation to the ACAS aircraft. When this interrogation is received, the transponder replies with a Comm-B reply whose MB field contains the RA report.

4.3.11.4.2 *Data link capability report.* The presence of an ACAS shall be indicated by its Mode S transponder to a ground station in the Mode S data link capability report.

Note.— This indication causes the transponder to set codes in a data link capability report as specified in 4.3.8.4.2.2.3.

4.3.12 Indications to the flight crew

4.3.12.1 CORRECTIVE AND PREVENTIVE RAS

Recommendation.— *Indications to the flight crew should distinguish between preventive and corrective RAs.*

4.3.12.2 ALTITUDE CROSSING RAS

Recommendation.— *If ACAS generates an altitude crossing RA, a specific indication should be given to the flight crew that it is crossing.*

4.4 PERFORMANCE OF THE ACAS II COLLISION AVOIDANCE LOGIC

Note 1.— *Caution is to be observed when considering potential improvements to ACAS since changes may affect more than one aspect of the system performance. It is essential that alternative designs would not degrade the performances of other designs and that such compatibility is demonstrated with a high degree of confidence. The performance specified in Section 4.4 is based on the performance achieved by TCAS Version 7.1-compliant systems.*

Note 2. — *The performance of ACAS X-compliant systems is improved compared to the performance of TCAS Version 7.1-compliant systems. For more information, refer to the Airborne Collision Avoidance System (ACAS) Manual (Doc 9863).*

4.4.1 Definitions relating to the performance of the collision avoidance logic

Note.— *The notation $[t_1, t_2]$ is used to indicate the interval between t_1 and t_2 .*

Altitude layer. Each encounter is attributed to one of six altitude layers as follows:

Layer	1	2	3	4	5	6
from		2 300 ft	5 000 ft	10 000 ft	20 000 ft	41 000 ft
to	2 300 ft	5 000 ft	10 000 ft	20 000 ft	41 000 ft	

The altitude layer of an encounter is determined by the average altitude of the two aircraft at closest approach.

Note.— *For the purposes of defining the performance of the collision avoidance logic, there is no need to specify the physical basis of the altitude measurement or the relationship between altitude and ground level.*

Approach angle. The difference in the ground headings of the two aircraft at closest approach, with 180 degrees defined as head on and 0 degrees defined as parallel.

Crossing encounter. An encounter in which the altitude separation of the two aircraft exceeds 100 ft at the beginning and at the end of the encounter window, and the relative vertical position of two aircraft at the end of the encounter window is reversed from that at the beginning of the encounter window.

Encounter. For the purposes of defining the performance of the collision avoidance logic, an encounter consists of two simulated aircraft trajectories. The horizontal coordinates of the aircraft represent the actual position of the aircraft but the vertical coordinate represents an altimeter measurement of altitude.

Encounter class. Encounters are classified according to whether or not the aircraft are transitioning at the beginning and end of the encounter window, and whether or not the encounter is crossing.

Encounter window. The time interval [$tca - 40$ s, $tca + 10$ s].

Horizontal miss distance (hmd). The minimum horizontal separation observed in an encounter.

Level aircraft. An aircraft that is not transitioning.

Original trajectory. The original trajectory of an ACAS-equipped aircraft is that followed by the aircraft in the same encounter when it was not ACAS equipped.

Original rate. The original rate of an ACAS-equipped aircraft at any time is its altitude rate at the same time when it followed the original trajectory.

Required rate. For the standard pilot model, the required rate is that closest to the original rate consistent with the RA.

tca. Nominally, the time of closest approach. For encounters in the standard encounter model (4.4.2.6), a reference time for the construction of the encounter at which various parameters, including the vertical and horizontal separation (*vmd* and *hmd*), are specified.

Note.— Encounters in the standard encounter model (4.4.2.6) are constructed by building the trajectories of the two aircraft outwards starting at tca. When the process is complete, tca may not be the precise time of closest approach and differences of a few seconds are acceptable.

Transitioning aircraft. An aircraft having an average vertical rate with a magnitude exceeding 400 feet per minute (ft/min), measured over some period of interest.

Turn extent. A heading difference defined as an aircraft's ground heading at the end of a turn minus its ground heading at the beginning of the turn.

Vertical miss distance (vmd). Notionally, the vertical separation at closest approach. For encounters in the standard encounter model (4.4.2.6), by construction the vertical separation at the time *tca*.

4.4.2 Conditions under which the requirements apply

4.4.2.1 The following assumed conditions shall apply to the performance requirements specified in 4.4.3 and 4.4.4:

- a) range and bearing measurements and an altitude report are available for the intruder each cycle as long as it is within 14 NM, but not when the range exceeds 14 NM;
- b) the errors in the range and bearing measurements conform to standard range and bearing error models (4.4.2.2 and 4.4.2.3);
- c) the intruder's altitude reports, which are its Mode C replies, are expressed in 100 ft quanta;
- d) an altitude measurement that has not been quantized and is expressed with a precision of 1 ft or better is available for own aircraft;
- e) errors in the altitude measurements for both aircraft are constant throughout any particular encounter;

- f) the errors in the altitude measurements for both aircraft conform to a standard altimetry error model (4.4.2.4);
- g) the pilot responses to RAs conform to a standard pilot model (4.4.2.5);
- h) the aircraft operate in an airspace in which close encounters, including those in which ACAS generates an RA, conform to a standard encounter model (4.4.2.6);
- i) ACAS-equipped aircraft are not limited in their ability to perform the manoeuvres required by their RAs; and
- j) as specified in 4.4.2.7:
 - 1) the intruder involved in each encounter is not equipped (4.4.2.7 a)); or
 - 2) the intruder is ACAS-equipped but follows a trajectory identical to that in the unequipped encounter (4.4.2.7 b)); or
 - 3) the intruder is equipped with an ACAS having a collision avoidance logic identical to that of own ACAS (4.4.2.7 c)).

Note.— The phrase “altitude measurement” refers to a measurement by an altimeter prior to any quantization.

4.4.2.1.1 The performance of the collision avoidance logic shall not degrade abruptly as the statistical distribution of the altitude errors or the statistical distributions of the various parameters that characterize the standard encounter model or the response of pilots to the advisories are varied, when surveillance reports are not available on every cycle or when the quantization of the altitude measurements for the intruder is varied or the altitude measurements for own aircraft are quantized.

4.4.2.2 STANDARD RANGE ERROR MODEL

The errors in the simulated range measurements shall be taken from a Normal distribution with mean 0 ft and standard deviation 50 ft.

4.4.2.3 STANDARD BEARING ERROR MODEL

The errors in the simulated bearing measurements shall be taken from a Normal distribution with mean 0.0 degrees and standard deviation 10.0 degrees.

4.4.2.4 STANDARD ALTIMETRY ERROR MODEL

4.4.2.4.1 The errors in the simulated altitude measurements shall be assumed to be distributed as a Laplacian distribution with zero mean having probability density

$$p(e) = \frac{1}{2\lambda} \exp\left(-\frac{|e|}{\lambda}\right)$$

4.4.2.4.2 The parameter λ required for the definition of the statistical distribution of altimeter error for each aircraft shall have one of two values, λ_1 and λ_2 , which depend on the altitude layer of the encounter as follows:

Layer	1		2		3		4		5		6	
	<i>m</i>	<i>ft</i>	<i>m</i>	<i>ft</i>	<i>m</i>	<i>ft</i>	<i>m</i>	<i>ft</i>	<i>m</i>	<i>ft</i>	<i>m</i>	<i>ft</i>
λ_1	10	35	11	38	13	43	17	58	22	72	28	94
λ_2	18	60	18	60	21	69	26	87	30	101	30	101

4.4.2.4.3 For an aircraft equipped with ACAS the value of λ shall be λ_1 .

4.4.2.4.4 For aircraft not equipped with ACAS, the value of λ shall be selected randomly using the following probabilities:

Layer	1	2	3	4	5	6
prob(λ_1)	0.391	0.320	0.345	0.610	0.610	0.610
prob(λ_2)	0.609	0.680	0.655	0.390	0.390	0.390

4.4.2.5 STANDARD PILOT MODEL

The standard pilot model used in the assessment of the performance of the collision avoidance logic shall be that:

- a) any RA is complied with by accelerating to the required rate (if necessary) after an appropriate delay;
- b) when the aircraft's current rate is the same as its original rate and the original rate complies with the RA, the aircraft continues at its original rate, which is not necessarily constant due to the possibility of acceleration in the original trajectory;
- c) when the aircraft is complying with the RA, its current rate is the same as the original rate and the original rate changes and consequently becomes inconsistent with the RA, the aircraft continues to comply with the RA;
- d) when an initial RA requires a change in altitude rate, the aircraft responds with an acceleration of 0.25 g after a delay of 5 s from the display of the RA;
- e) when an RA is modified and the original rate complies with the modified RA, the aircraft returns to its original rate (if necessary) with the acceleration specified in g) after the delay specified in h);
- f) when an RA is modified and the original rate does not comply with the modified RA, the aircraft responds to comply with the RA with the acceleration specified in g) after the delay specified in h);
- g) the acceleration used when an RA is modified is 0.25 g unless the modified RA is a reversed sense RA or an increased rate RA in which case the acceleration is 0.35 g;
- h) the delay used when an RA is modified is 2.5 s unless this results in the acceleration starting earlier than 5 s from the initial RA in which case the acceleration starts 5 s from the initial RA; and
- i) when an RA is cancelled, the aircraft returns to its original rate (if necessary) with an acceleration of 0.25 g after a delay of 2.5 s.

4.4.2.6 STANDARD ENCOUNTER MODEL

4.4.2.6.1 ELEMENTS OF THE STANDARD ENCOUNTER MODEL

4.4.2.6.1.1 In order to calculate the effect of ACAS on the risk of collision (4.4.3) and the compatibility of ACAS with air traffic management (ATM) (4.4.4), sets of encounters shall be created for each of:

- a) the two aircraft address orderings;
- b) the six altitude layers;
- c) nineteen encounter classes; and
- d) nine or ten *vmd* bins as specified in 4.4.2.6.2.4.

The results for these sets shall be combined using the relative weightings given in 4.4.2.6.2.

4.4.2.6.1.1.1 Each set of encounters shall contain at least 500 independent, randomly generated encounters.

4.4.2.6.1.1.2 The two aircraft trajectories in each encounter shall be constructed with the following randomly selected characteristics:

- a) in the vertical plane:
 - 1) a *vmd* from within the appropriate *vmd* bin;
 - 2) a vertical rate for each aircraft at the beginning of the encounter window, \dot{z}_1 , and at the end of the encounter window, \dot{z}_2 ;
 - 3) a vertical acceleration; and
 - 4) a start time for the vertical acceleration; and
- b) and in the horizontal plane:
 - 1) an *hmd*;
 - 2) an approach angle;
 - 3) a speed for each aircraft at closest approach;
 - 4) a decision for each aircraft whether or not it turns;
 - 5) the turn extent; the bank angle; and the turn end time;
 - 6) a decision for each aircraft whether or not its speed changes; and
 - 7) the magnitude of the speed change.

Note.— It is possible for the selections made for the various characteristics of an encounter to be irreconcilable. When this occurs, the problem can be resolved by discarding either the selection for a particular characteristic or the whole encounter, as most appropriate.

4.4.2.6.1.3 Two models shall be used for the statistical distribution of *hmd* (4.4.2.6.4.1). For calculations of the effect of ACAS on the risk of collision (4.4.3), *hmd* shall be constrained to be less than 500 ft. For calculations of the compatibility of ACAS with ATM (4.4.4), *hmd* shall be selected from a larger range of values (4.4.2.6.4.1.2).

Note.— 4.4.2.6.2 and 4.4.2.6.3 specify vertical characteristics for the aircraft trajectories in the standard encounter model that depend on whether the *hmd* is constrained to be small (“for calculating risk ratio”) or can take larger values (“for ATM compatibility”). Otherwise, the characteristics of the encounters in the vertical and horizontal planes are independent.

4.4.2.6.2 ENCOUNTER CLASSES AND WEIGHTS

4.4.2.6.2.1 *Aircraft address.* Each aircraft shall be equally likely to have the higher aircraft address.

4.4.2.6.2.2 *Altitude layers.* The relative weights of the altitude layers shall be as follows:

Layer	1	2	3	4	5	6
prob(layer)	0.13	0.25	0.32	0.22	0.07	0.01

4.4.2.6.2.3 Encounter classes

4.4.2.6.2.3.1 The encounters shall be classified according to whether the aircraft are level (L) or transitioning (T) at the beginning (before *tca*) and end (after *tca*) of the encounter window and whether or not the encounter is crossing, as follows:

Class	Aircraft No. 1		Aircraft No. 2		Crossing
	before <i>tca</i>	after <i>tca</i>	before <i>tca</i>	after <i>tca</i>	
1	L	L	T	T	yes
2	L	L	L	T	yes
3	L	L	T	L	yes
4	T	T	T	T	yes
5	L	T	T	T	yes
6	T	T	T	L	yes
7	L	T	L	T	yes
8	L	T	T	L	yes
9	T	L	T	L	yes
10	L	L	L	L	no
11	L	L	T	T	no
12	L	L	L	T	no
13	L	L	T	L	no
14	T	T	T	T	no
15	L	T	T	T	no
16	T	T	T	L	no
17	L	T	L	T	no
18	L	T	T	L	no
19	T	L	T	L	no

4.4.2.6.2.3.2 The relative weights of the encounter classes shall depend on layer as follows:

Class	for calculating risk ratio		for ATM compatibility	
	Layers 1-3	Layers 4-6	Layers 1-3	Layers 4-6
1	0.00502	0.00319	0.06789	0.07802
2	0.00030	0.00018	0.00408	0.00440
3	0.00049	0.00009	0.00664	0.00220
4	0.00355	0.0027	0.04798	0.06593
5	0.00059	0.00022	0.00791	0.00549
6	0.00074	0.00018	0.00995	0.00440
7	0.00002	0.00003	0.00026	0.00082
8	0.00006	0.00003	0.00077	0.00082
9	0.00006	0.00003	0.00077	0.00082
10	0.36846	0.10693	0.31801	0.09011
11	0.26939	0.41990	0.23252	0.35386
12	0.06476	0.02217	0.05590	0.01868
13	0.07127	0.22038	0.06151	0.18571
14	0.13219	0.08476	0.11409	0.07143
15	0.02750	0.02869	0.02374	0.02418
16	0.03578	0.06781	0.03088	0.05714
17	0.00296	0.00098	0.00255	0.00082
18	0.00503	0.00522	0.00434	0.00440
19	0.01183	0.03651	0.01021	0.03077

4.4.2.6.2.4 vmd bins

4.4.2.6.2.4.1 The *vmd* of each encounter shall be taken from one of ten *vmd* bins for the non-crossing encounter classes, and from one of nine or ten *vmd* bins for the crossing encounter classes. Each *vmd* bin shall have an extent of 100 ft for calculating risk ratio, or an extent of 200 ft for calculating compatibility with ATM. The maximum *vmd* shall be 1 000 ft for calculating risk ratio, and 2 000 ft otherwise.

4.4.2.6.2.4.2 For non-crossing encounter classes, the relative weights of the *vmd* bins shall be as follows:

vmd bin	for calculating risk ratio	for ATM compatibility
1	0.013	0.128
2	0.026	0.135
3	0.035	0.209
4	0.065	0.171
5	0.100	0.160
6	0.161	0.092
7	0.113	0.043
8	0.091	0.025
9	0.104	0.014
10	0.091	0.009

Note.— The weights for the *vmd* bins do not sum to 1.0. The weights specified are based on an analysis of encounters captured in ATC ground radar data. The missing proportion reflects the fact that the encounters captured included some with *vmd* exceeding the maximum *vmd* in the model.

4.4.2.6.2.4.3 For the crossing classes, the relative weights of the *vmd* bins shall be as follows:

<i>vmd bin</i>	<i>for calculating risk ratio</i>	<i>for ATM compatibility</i>
1	0	0.064
2	0.026	0.144
3	0.036	0.224
4	0.066	0.183
5	0.102	0.171
6	0.164	0.098
7	0.115	0.046
8	0.093	0.027
9	0.106	0.015
10	0.093	0.010

Note.— For the crossing classes, *vmd* must exceed 100 ft so that the encounter qualifies as a crossing encounter. Thus, for the calculation of risk ratio there is no *vmd* bin 1, and for calculations of the compatibility with ATM *vmd* bin 1 is limited to [100 ft, 200 ft].

4.4.2.6.3 CHARACTERISTICS OF THE AIRCRAFT TRAJECTORIES IN THE VERTICAL PLANE

4.4.2.6.3.1 *vmd*. The *vmd* for each encounter shall be selected randomly from a distribution that is uniform in the interval covered by the appropriate *vmd* bin.

4.4.2.6.3.2 Vertical rate

4.4.2.6.3.2.1 For each aircraft in each encounter, either the vertical rate shall be constant (\dot{z}) or the vertical trajectory shall be constructed so that the vertical rate at $tca - 35$ s is \dot{z}_1 and the vertical rate at $tca + 5$ s is \dot{z}_2 . Each vertical rate, \dot{z} , \dot{z}_1 or \dot{z}_2 , shall be determined by first selecting randomly an interval within which it lies and then selecting the precise value from a distribution that is uniform over the interval selected.

4.4.2.6.3.2.2 The intervals within which the vertical rates lie shall depend on whether the aircraft is level, i.e. marked “L” in 4.4.2.6.2.3.1, or transitioning, i.e. marked “T” in 4.4.2.6.2.3.1, and shall be as follows:

<i>L</i>	<i>T</i>
[240 ft/min, 400 ft/min]	[3 200 ft/min, 6 000 ft/min]
[80 ft/min, 240 ft/min]	[400 ft/min, 3 200 ft/min]
[-80 ft/min, 80 ft/min]	[-400 ft/min, 400 ft/min]
[-240 ft/min, -80 ft/min]	[-3 200 ft/min, -400 ft/min]
[-400 ft/min, -240 ft/min]	[-6 000 ft/min, -3 200 ft/min]

4.4.2.6.3.2.3 For aircraft that are level over the entire encounter window, the vertical rate \dot{z} shall be constant. The probabilities for the intervals within which \dot{z} lies shall be as follows:

\dot{z} (ft/min)	prob(\dot{z})
[240 ft/min, 400 ft/min]	0.0382
[80 ft/min, 240 ft/min]	0.0989
[-80 ft/min, 80 ft/min]	0.7040
[-240 ft/min, -80 ft/min]	0.1198
[-400 ft/min, -240 ft/min]	0.0391

4.4.2.6.3.2.4 For aircraft that are not level over the entire encounter window, the intervals for \dot{z}_1 and \dot{z}_2 shall be determined jointly by random selection using joint probabilities that depend on altitude layer and on whether the aircraft is transitioning at the beginning of the encounter window (Rate-to-Level), at the end of the encounter window (Level-to-Rate) or at both the beginning and the end (Rate-to-Rate). The joint probabilities for the vertical rate intervals shall be as follows:

for aircraft with Rate-to-Level trajectories in layers 1 to 3,

\dot{z}_2 interval	joint probability of \dot{z}_1 and \dot{z}_2 interval						
	-6 000 ft/min	-3 200 ft/min	-400 ft/min	400 ft/min	3 200 ft/min	6 000 ft/min	\dot{z}_1
[240 ft/min, 400 ft/min]	0.0019	0.0169	0.0131	0.1554	0.0000		
[80 ft/min, 240 ft/min]	0.0000	0.0187	0.0019	0.1086	0.0000		
[-80 ft/min, 80 ft/min]	0.0037	0.1684	0.0094	0.1124	0.0075		
[-240 ft/min, -80 ft/min]	0.0037	0.1461	0.0094	0.0243	0.0037		
[-400 ft/min, -240 ft/min]	0.0000	0.1742	0.0094	0.0094	0.0019		

for aircraft with Rate-to-Level trajectories in layers 4 to 6,

\dot{z}_2 interval	joint probability of \dot{z}_1 and \dot{z}_2 interval						
	-6 000 ft/min	-3 200 ft/min	-400 ft/min	400 ft/min	3 200 ft/min	6 000 ft/min	\dot{z}_1
[240 ft/min, 400 ft/min]	0.0105	0.0035	0.0000	0.1010	0.0105		
[80 ft/min, 240 ft/min]	0.0035	0.0418	0.0035	0.1776	0.0279		
[-80 ft/min, 80 ft/min]	0.0279	0.1219	0.0000	0.2403	0.0139		
[-240 ft/min, -80 ft/min]	0.0035	0.0767	0.0000	0.0488	0.0105		
[-400 ft/min, -240 ft/min]	0.0105	0.0453	0.0035	0.0174	0.0000		

for aircraft with Level-to-Rate trajectories in layers 1 to 3,

\dot{z}_2 interval	joint probability of \dot{z}_1 and \dot{z}_2 interval						
	-400 ft/min	-240 ft/min	-80 ft/min	80 ft/min	240 ft/min	400 ft/min	\dot{z}_1
[3 200 ft/min, 6000 ft/min]	0.0000	0.0000	0.0000	0.0000	0.0000		
[400 ft/min, 3200 ft/min]	0.0074	0.0273	0.0645	0.0720	0.1538		
[-400 ft/min, 400 ft/min]	0.0000	0.0000	0.0000	0.0000	0.0000		
[-3 200 ft/min, -400 ft/min]	0.2978	0.2084	0.1365	0.0273	0.0050		
[-6 000ft/min, -3 200ft/min]	0.0000	0.0000	0.0000	0.0000	0.0000		

for aircraft with Level-to-Rate trajectories in layers 4 to 6,

\dot{z}_2 interval

joint probability of \dot{z}_1 and \dot{z}_2 interval

[3 200 ft/min, 6 000 ft/min]	0.0000	0.0000	0.0000	0.0000	0.0192	
[400 ft/min, 3 200 ft/min]	0.0000	0.0000	0.0962	0.0577	0.1154	
[-400 ft/min, 400 ft/min]	0.0000	0.0000	0.0000	0.0000	0.0000	
[-3 200 ft/min, -400 ft/min]	0.1346	0.2692	0.2308	0.0577	0.0192	
[-6 000 ft/min, -3 200 ft/min]	0.0000	0.0000	0.0000	0.0000	0.0000	
	-400 ft/min	-240 ft/min	-80 ft/min	80 ft/min	240 ft/min	400 ft/min

for aircraft with Rate-to-Rate trajectories in layers 1 to 3,

\dot{z}_2 interval

joint probability of \dot{z}_1 and \dot{z}_2 interval

[3 200 ft/min, 6 000 ft/min]	0.0000	0.0000	0.0007	0.0095	0.0018	
[400 ft/min, 3 200 ft/min]	0.0000	0.0018	0.0249	0.2882	0.0066	
[-400 ft/min, 400 ft/min]	0.0000	0.0000	0.0000	0.0000	0.0000	
[-3 200 ft/min, -400 ft/min]	0.0048	0.5970	0.0600	0.0029	0.0011	
[-6 000 ft/min, -3 200 ft/min]	0.0000	0.0007	0.0000	0.0000	0.0000	
	-6 000 ft/min	-3 200 ft/min	-400 ft/min	400 ft/min	3 200 ft/min	6 000 ft/min

for aircraft with Rate-to-Rate trajectories in layers 4 to 6,

\dot{z}_2 interval

joint probability of \dot{z}_1 and \dot{z}_2 interval

[3 200 ft/min, 6 000 ft/min]	0.0014	0.0000	0.0028	0.0110	0.0069	
[400 ft/min, 3 200 ft/min]	0.0028	0.0028	0.0179	0.4889	0.0523	
[-400 ft/min, 400 ft/min]	0.0000	0.0000	0.0000	0.0000	0.0000	
[-3 200 ft/min, -400 ft/min]	0.0317	0.3029	0.0262	0.0152	0.0028	
[-6 000 ft/min, -3 200 ft/min]	0.0110	0.0220	0.0014	0.0000	0.0000	
	-6 000 ft/min	-3 200 ft/min	-400 ft/min	400 ft/min	3 200 ft/min	6 000 ft/min

4.4.2.6.3.2.5 For a Rate-to-Rate track, if line $|\dot{z}_2 - \dot{z}_1| < 566$ ft/min then the track shall be constructed with a constant rate equal to \dot{z}_1 .

4.4.2.6.3.3 Vertical acceleration

4.4.2.6.3.3.1 Subject to 4.4.2.6.3.2.5, for aircraft that are not level over the entire encounter window, the rate shall be constant and equal to \dot{z}_1 over at least the interval $[tca - 40 \text{ s}, tca - 35 \text{ s}]$ at the beginning of the encounter window, and shall be constant and equal to \dot{z}_2 over at least the interval $[tca + 5 \text{ s}, tca + 10 \text{ s}]$ at the end of the encounter window. The vertical acceleration shall be constant in the intervening period.

4.4.2.6.3.3.2 The vertical acceleration (\ddot{z}) shall be modelled as follows:

$$\ddot{z} = (A\dot{z}_2 - \dot{z}_1) + \varepsilon$$

where the parameter A is case-dependent as follows:

Case	$A(s^{-1})$	
	Layers 1-3	Layers 4-6
Rate-to-Level	0.071	0.059
Level-to-Rate	0.089	0.075
Rate-to-Rate	0.083	0.072

and the error ε is selected randomly using the following probability density:

$$p(\varepsilon) = \frac{1}{2\mu} \exp\left(-\frac{|\varepsilon|}{\mu}\right)$$

where $\mu = 0.3 \text{ ft s}^{-2}$.

Note.— The sign of the acceleration \ddot{z} is determined by \dot{z}_1 and \dot{z}_2 . An error ε that reverses this sign must be rejected and the error reselected.

4.4.2.6.3.4 *Acceleration start time.* The acceleration start time shall be distributed uniformly in the time interval [$tca - 35 \text{ s}$, $tca - 5 \text{ s}$] and shall be such that \dot{z}_2 is achieved no later than $tca + 5 \text{ s}$.

4.4.2.6.4 CHARACTERISTICS OF THE AIRCRAFT TRAJECTORIES IN THE HORIZONTAL PLANE

4.4.2.6.4.1 Horizontal miss distance

4.4.2.6.4.1.1 For calculations of the effect of ACAS on the risk of collision (4.4.3), hmd shall be uniformly distributed in the range [0, 500 ft].

4.4.2.6.4.1.2 For calculations concerning the compatibility of ACAS with ATM (4.4.4), hmd shall be distributed so that the values of hmd have the following cumulative probabilities:

hmd (ft)	cumulative probability		hmd (ft)	cumulative probability	
	Layers 1-3	Layers 4-6		Layers 1-3	Layers 4-6
0	0.000	0.000	17 013	0.999	0.868
1 215	0.152	0.125	18 228	1.000	0.897
2 430	0.306	0.195	19 443		0.916
3 646	0.482	0.260	20 659		0.927
4 860	0.631	0.322	21 874		0.939
6 076	0.754	0.398	23 089		0.946
7 921	0.859	0.469	24 304		0.952
8 506	0.919	0.558	25 520		0.965
9 722	0.954	0.624	26 735		0.983
10 937	0.972	0.692	27 950		0.993

hmd (ft)	cumulative probability		hmd (ft)	cumulative probability	
	Layers 1-3	Layers 4-6		Layers 1-3	Layers 4-6
12 152	0.982	0.753	29 165		0.996
13 367	0.993	0.801	30 381		0.999
14 582	0.998	0.821	31 596		1.000
15 798	0.999	0.848			

4.4.2.6.4.2 *Approach angle.* The cumulative distribution for the horizontal approach angle shall be as follows:

approach angle (deg.)	cumulative probability		approach angle (deg.)	cumulative probability	
	Layers 1-3	Layers 4-6		Layers 1-3	Layers 4-6
0	0.00	0.00	100	0.38	0.28
10	0.14	0.05	110	0.43	0.31
20	0.17	0.06	120	0.49	0.35
30	0.18	0.08	130	0.55	0.43
40	0.19	0.08	140	0.62	0.50
50	0.21	0.10	150	0.71	0.59
60	0.23	0.13	160	0.79	0.66
70	0.25	0.14	170	0.88	0.79
80	0.28	0.19	180	1.00	1.00
90	0.32	0.22			

4.4.2.6.4.3 *Aircraft speed.* The cumulative distribution for each aircraft's horizontal ground speed at closest approach shall be as follows:

ground speed (kt)	cumulative probability		ground speed (kt)	cumulative probability	
	Layers 1-3	Layers 4-6		Layers 1-3	Layers 4-6
45	0.000		325	0.977	0.528
50	0.005		350	0.988	0.602
75	0.024	0.000	375	0.997	0.692
100	0.139	0.005	400	0.998	0.813
125	0.314	0.034	425	0.999	0.883
150	0.486	0.064	450	1.000	0.940
175	0.616	0.116	475		0.972
200	0.700	0.171	500		0.987
225	0.758	0.211	525		0.993
250	0.821	0.294	550		0.998
275	0.895	0.361	575		0.999
300	0.949	0.427	600		1.000

4.4.2.6.4.4 *Horizontal manoeuvre probabilities.* For each aircraft in each encounter, the probability of a turn, the probability of a speed change given a turn, and the probability of a speed change given no turn shall be as follows:

<i>Layer</i>	<i>Prob(turn)</i>	<i>Prob(speed change) given a turn</i>	<i>Prob(speed change) given no turn</i>
1	0.31	0.20	0.5
2	0.29	0.20	0.25
3	0.22	0.10	0.15
4, 5, 6	0.16	0.05	0.10

4.4.2.6.4.4.1 Given a speed change, the probability of a speed increase shall be 0.5 and the probability of a speed decrease shall be 0.5.

4.4.2.6.4.5 *Turn extent.* The cumulative distribution for the extent of any turn shall be as follows:

<i>Turn extent (deg.)</i>	<i>cumulative probability</i>	
	<i>Layers 1-3</i>	<i>Layers 4-6</i>
15	0.00	0.00
30	0.43	0.58
60	0.75	0.90
90	0.88	0.97
120	0.95	0.99
150	0.98	1.00
180	0.99	
210	1.00	

4.4.2.6.4.5.1 The direction of the turn shall be random, with the probability of a left turn being 0.5 and the probability of a right turn being 0.5.

4.4.2.6.4.6 *Bank angle.* An aircraft's bank angle during a turn shall not be less than 15 degrees. The probability that it equals 15 degrees shall be 0.79 in layers 1-3 and 0.54 in layers 4-5. The cumulative distribution for larger bank angles shall be as follows:

<i>Bank angle (deg.)</i>	<i>cumulative probability</i>	
	<i>Layers 1-3</i>	<i>Layers 4-6</i>
15	0.79	0.54
25	0.96	0.82
35	0.99	0.98
50	1.00	1.00

4.4.2.6.4.7 *Turn end time.* The cumulative distribution for each aircraft's turn end time shall be as follows:

<i>Turn end time (seconds before tca)</i>	<i>cumulative probability</i>	
	<i>Layers 1-3</i>	<i>Layers 4-6</i>
0	0.42	0.28
5	0.64	0.65
10	0.77	0.76
15	0.86	0.85
20	0.92	0.94
25	0.98	0.99
30	1.00	1.00

4.4.2.6.4.8 *Speed change.* A constant acceleration or deceleration shall be randomly selected for each aircraft performing a speed change in a given encounter, and shall be applied for the duration of the encounter. Accelerations shall be uniformly distributed between 2 kt/s and 6 kt/s. Decelerations shall be uniformly distributed between 1 kt/s and 3 kt/s.

4.4.2.7 ACAS EQUIPAGE OF THE INTRUDER

The performance requirements specified in 4.4.3 and 4.4.4 each apply to three distinct situations in which the following conditions concerning the intruder's ACAS and trajectory shall apply:

- a) where the intruder involved in each encounter is not equipped (4.4.2.1 j) 1)), it follows a trajectory identical to that which it follows when own aircraft is not equipped;
- b) where the intruder is ACAS-equipped but follows a trajectory identical to that in the unequipped encounter (4.4.2.1 j) 2)):
 - 1) it follows the identical trajectory regardless of whether or not there is an RA;
 - 2) the intruder ACAS generates an RA and transmits an RAC that is received immediately after any RA is first announced to the pilot of own aircraft;
 - 3) the sense of the RAC generated by the intruder ACAS and transmitted to own aircraft is opposite to the sense of the first RAC selected and transmitted to the intruder by own aircraft (4.3.6.1.3);
 - 4) the RAC transmitted by the intruder is received by own aircraft; and
 - 5) the requirements apply both when own aircraft has the lower aircraft address and when the intruder aircraft has the lower aircraft address; and
- c) where the intruder is equipped with an ACAS having a collision avoidance logic identical to that of own ACAS (4.4.2.1 j) 3)):
 - 1) the conditions relating to the performance of own aircraft, ACAS and pilot apply equally to the intruder aircraft, ACAS and pilot;
 - 2) RACs transmitted by one aircraft are received by the other; and
 - 3) the requirements apply both when own aircraft has the lower aircraft address and when the intruder aircraft has the lower aircraft address.

4.4.2.8 COMPATIBILITY BETWEEN DIFFERENT COLLISION AVOIDANCE LOGIC DESIGNS

Recommendation.— *When considering alternative collision avoidance logic designs, certification authorities should verify that:*

- a) *the performances of the alternative design are acceptable in encounters involving ACAS units that use existing designs; and*
- b) *the performances of the existing designs are not degraded by the use of the alternative design.*

Note.— *To address the compatibility between different collision avoidance logic designs, the conditions described in 4.4.2.7 b) are the most severe that can be anticipated in this respect.*

4.4.3 Reduction in the risk of collision

Under the conditions of 4.4.2, the collision avoidance logic shall be such that the expected number of collisions is reduced to the following proportions of the number expected in the absence of ACAS:

- a) when the intruder is not ACAS equipped 0.18;
- b) when the intruder is equipped but does not respond 0.32; and
- c) when the intruder is equipped and responds 0.04.

4.4.4 Compatibility with air traffic management (ATM)

4.4.4.1 NUISANCE ALERT RATE

4.4.4.1.1 Under the conditions of 4.4.2, the collision avoidance logic shall be such that the proportion of RAs which are a “nuisance” (4.4.4.1.2) shall not exceed:

- .06 when own aircraft’s vertical rate at the time the RA is first issued is less than 400 ft/min; or
- .08 when own aircraft’s vertical rate at the time the RA is first issued exceeds 400 ft/min.

Note.— *This requirement is not qualified by the ACAS equipage of the intruder (4.4.2.7) since it has negligible effect on the occurrence and frequency of nuisance RAs.*

4.4.4.1.2 An RA shall be considered a “nuisance” for the purposes of 4.4.4.1.1 unless, at some point in the encounter in the absence of ACAS, the horizontal separation and the vertical separation are simultaneously less than the following values:

	<i>horizontal separation</i>	<i>vertical separation</i>
<i>above FL100</i>	2.0 NM	750 ft
<i>below FL100</i>	1.2 NM	750 ft

4.4.4.2 COMPATIBLE SENSE SELECTION

Under the conditions of 4.4.2, the collision avoidance logic shall be such that the proportion of encounters in which following the RA results in an altitude separation at closest approach with the opposite sign to that occurring in the absence of ACAS shall not exceed the following values:

- a) when the intruder is not ACAS equipped 0.08;
- b) when the intruder is equipped but does not respond 0.08; and
- c) when the intruder is equipped and responds 0.12.

4.4.4.3 DEVIATIONS CAUSED BY ACAS

4.4.4.3.1 Under the conditions of 4.4.2, the collision avoidance logic shall be such that the number of RAs resulting in “deviations” (4.4.4.3.2) greater than the values indicated shall not exceed the following proportions of the total number of RAs:

	<i>when own aircraft's vertical rate at the time the RA is first issued</i>	
	<i>is less than 400ft/min</i>	<i>exceeds 400ft/min</i>
<i>when the intruder is not ACAS equipped,</i>		
<i>for deviations ≥ 300 ft</i>	0.15	0.23
<i>for deviations ≥ 600 ft</i>	0.04	0.13
<i>for deviations $\geq 1\ 000$ ft</i>	0.01	0.07
<i>when the intruder is equipped but does not respond,</i>		
<i>for deviations ≥ 300 ft</i>	0.23	0.35
<i>for deviations ≥ 600 ft</i>	0.06	0.16
<i>for deviations $\geq 1\ 000$ ft</i>	0.02	0.07
<i>when the intruder is equipped and responds,</i>		
<i>for deviations ≥ 300 ft</i>	0.11	0.23
<i>for deviations ≥ 600 ft</i>	0.02	0.12
<i>for deviations $\geq 1\ 000$ ft</i>	0.01	0.06

4.4.4.3.2 For the purposes of 4.4.4.3.1, the “deviation” of the equipped aircraft from the original trajectory shall be measured in the interval from the time at which the RA is first issued until the time at which, following cancellation of the RA, the equipped aircraft has recovered its original altitude rate. The deviation shall be calculated as the largest altitude difference at any time in this interval between the trajectory followed by the equipped aircraft when responding to its RA and its original trajectory.

4.4.5 Relative value of conflicting objectives

Recommendation.— *The collision avoidance logic should be such as to reduce as much as practicable the risk of collision (measured as defined in 4.4.3) and limit as much as practicable the disruption to ATM (measured as defined in 4.4.4).*

4.5 ACAS USE OF EXTENDED SQUITTER

4.5.1 ACAS hybrid surveillance using extended squitter position data

Note.— Surveillance protocols defined in this section are for ACAS hybrid surveillance, and surveillance protocols for ACAS not equipped for hybrid surveillance are defined in 4.3.7.1.

4.5.1.1 DEFINITIONS

Active surveillance. The process of tracking an intruder by using the information gained from the replies to own ACAS interrogations.

Extended hybrid surveillance. The process of using qualified ADS-B airborne position messages via 1 090 MHz extended squitter without validating 1 090 extended squitter data for the track by ACAS active interrogations.

Hybrid surveillance. The process of using a combination of active surveillance and passive surveillance with validated data to update an ACAS track in order to preserve ACAS independence.

Passive surveillance. The process of tracking another aircraft without interrogating it, by using the other aircraft's extended squitters. ACAS uses the information obtained via 1 090 MHz extended squitter to monitor the need for active surveillance, but not for any other purpose. Passive surveillance applies to both hybrid and extended hybrid surveillance.

Validation. The process of verifying the relative position of an intruder using passive information via 1 090 MHz extended squitter by comparing it to the relative position obtained by ACAS active interrogation.

4.5.1.2 An ACAS equipped to receive extended squitter airborne position messages for passive surveillance of non-threatening intruders shall utilize this passive position information in the following manner.

4.5.1.3 PASSIVE SURVEILLANCE

4.5.1.3.1 EXTENDED HYBRID SURVEILLANCE

4.5.1.3.1.1 Systems using extended hybrid surveillance mode shall establish a track in such a way that no interrogations are performed, i.e. acquiring the track through exclusive use of ADS-B extended squitter, when the following conditions are met:

- a) own aircraft position data meets the following minimum level of quality:
 - 1) own aircraft horizontal position uncertainty (95 per cent) is < 0.1 NM; and
 - 2) own aircraft horizontal position integrity shall be such that the probability of an undetected position error, which is greater than 0.6 NM radius, is less than 1×10^{-7} .
- b) the received signal strength is equal or less than -68 dBm ± 2 dB (extended hybrid surveillance minimum triggering level), or own aircraft is operating on the surface; and
- c) the intruder data quality meets the following minimum requirements:
 - 1) the ADS-B version number ≥ 2 ;

- 2) the reported NIC ≥ 6 (< 0.6 NM);
- 3) the reported NACp ≥ 7 (< 0.1 NM);
- 4) the reported SIL = 3;
- 5) the reported SDA = 2 or 3; and
- 6) the barometric altitude is valid.

4.5.1.3.1.2 The system shall not use ADS-rebroadcast (ADS-R) and TIS-B data to passively acquire an aircraft.

Note 1.— ADS-R is described in the Technical Provisions for Mode S Services and Extended Squitter (Doc 9871).

Note 2.— The signal level strength cannot be applied to ADS-R and TIS-B data.

4.5.1.3.1.3 A track maintained under extended hybrid surveillance mode shall transition to a track maintained under active surveillance mode if range and altitude of hybrid threat criteria are met.

Note.— Information concerning range and altitude hybrid threat criteria can be found in RTCA DO-300A Change 1/EUROCAE ED-221A – Minimum Operational Performance Standards (MOPS) for Traffic Alert and Collision Avoidance System II (TCAS II) Hybrid Surveillance.

4.5.1.3.1.4 A track under extended hybrid surveillance mode shall transition to a track under hybrid surveillance mode, if:

- a) the signal indicates a high probability to be in close proximity, i.e. signal $>$ extended hybrid surveillance MTL, except when operating on the airport surface; or
- b) intruder data or own data quality does not meet minimum requirements.

4.5.1.3.2 *Validation.* To validate the position of an intruder reported by extended squitter and not meeting the criteria for extended hybrid surveillance mode, ACAS shall determine the relative range and relative bearing as computed from the position and geographical heading of own aircraft and the intruder's position as reported in the extended squitter. This derived range and relative bearing and the altitude reported in the squitter shall be compared to the range, relative bearing and altitude determined by active ACAS interrogation requiring a short reply from the aircraft. Differences between the derived and measured range and relative bearing and the squitter and reply altitude shall be computed and used in tests to determine whether the extended squitter data is valid. If these tests are satisfied the passive position shall be considered to be validated and the track shall be maintained on passive data unless it is a near threat as described in 4.5.1.4. If any of these validation tests fail, active surveillance shall be used to track the intruder.

Note.— Suitable tests for validating extended squitter data information for the purposes of ACAS hybrid surveillance can be found in RTCA DO-300A Change 1/EUROCAE ED-221A – Minimum Operational Performance Standards (MOPS) for Traffic Alert and Collision Avoidance System II (TCAS II) Hybrid Surveillance.

4.5.1.3.3 *Supplementary active interrogations.* In order to ensure that an intruder's track is updated at least as frequently as required in the absence of extended squitter data (4.3.7.1.2.2), each time a track is updated using squitter information the time at which an active interrogation would next be required shall be calculated. An active interrogation shall be made at that time if a further squitter has not been received before the interrogation is due.

4.5.1.4 *Near threat.* An intruder shall be tracked under active surveillance if it is a near threat, as determined by separate tests on the range and altitude of the aircraft. These tests shall be such that an intruder is considered a near threat before it becomes a potential threat, and thus triggers a traffic advisory as described in 4.3.3. These tests shall be performed once per second. All near threats, potential threats and threats shall be tracked using active surveillance.

Note.— *Suitable tests for determining that an intruder is a near threat can be found in RTCA DO-300A Change 1/EUROCAE ED-221A – Minimum Operational Performance Standards (MOPS) for Traffic Alert and Collision Avoidance System II (TCAS II) Hybrid Surveillance.*

4.5.1.5 *Revalidation and monitoring.* If an aircraft is being tracked using passive surveillance and if criteria for extended hybrid surveillance mode are not met, periodic active interrogations shall be performed to validate and monitor the extended squitter data as required in 4.5.1.3.2. The rates of revalidation shall be between once per minute and once per 10 seconds. The tests required in 4.5.1.3.2 shall be performed for each interrogation, and active surveillance shall be used to track the intruder if these revalidation tests fail.

Note.— *More information about criteria of revalidation rate can be found in RTCA DO-300A Change 1/EUROCAE ED-221A – Minimum Operational Performance Standards (MOPS) for Traffic Alert and Collision Avoidance System II (TCAS II) Hybrid Surveillance.*

4.5.1.6 *Full active surveillance.* If the following condition is met for a track being updated via passive surveillance data:

- a) $|a| \leq 10\,000$ ft and both;
- b) $|a| \leq 3\,000$ ft or $|a - 3\,000 \text{ ft}| / |\dot{a}| \leq 60$ s; and
- c) $r \leq 3$ NM or $(r - 3 \text{ NM}) / |\dot{r}| \leq 60$ s;

where: a = intruder altitude separation in ft

\dot{a} = altitude rate estimate in ft/s

r = intruder slant range in NM

\dot{r} = range rate estimate in NM/s

the aircraft shall be declared an active track and shall be updated on active range measurements once per second for as long as the above condition is met.

4.5.1.6.1 All near threats, potential threats and threats shall be tracked using active surveillance.

4.5.1.6.2 Adequate protection against residual ADS-B position data shall be provided in track state computation when transitioning from passive to active surveillance, in order to avoid unnecessary advisories during such transitions.

Note.— *A suitable means of protection can be found in RTCA DO-300 Change 2 and RTCA DO-300A Change 1/EUROCAE ED-221A – Minimum Operational Performance Standards (MOPS) for Traffic Alert and Collision Avoidance System II (TCAS II) Hybrid Surveillance, Section 2.2.6.2.*

4.5.1.6.3 A track under active surveillance shall transition to passive surveillance if it is neither a near threat, potential threat nor a threat. The tests used to determine it is no longer a near threat shall be similar to those used in 4.5.1.4 but with larger thresholds in order to have hysteresis which prevents the possibility of frequent transitions between active and passive surveillance.

Note.— *Suitable tests for determining that an intruder is no longer a near threat can be found in RTCA DO-300A Change 1/EUROCAE ED-221A – Minimum Operational Performance Standards (MOPS) for Traffic Alert and Collision Avoidance System II (TCAS II) Hybrid Surveillance.*

4.5.2 ACAS operation with an improved receiver MTL

Note.— Applications of extended squitter that are independent of ACAS might be implemented (for convenience) using the ACAS receiver. The use of an improved receiver minimum triggering level (MTL) will make it possible to receive extended squitters from ranges of up to 60 NM and beyond in support of such applications.

4.5.2.1 An ACAS operating with a receiver having a MTL more sensitive than -74 dBm shall implement the capabilities specified in the following paragraphs.

4.5.2.2 *Dual minimum triggering levels.* The ACAS receiver shall be capable of setting an indication for each squitter reception as to whether the reply would have been detected by an ACAS operating with a conventional MTL (-74 dBm). Squitter receptions received at the conventional MTL shall be passed to the ACAS surveillance function for further processing. Squitter receptions that do not meet this condition shall not be passed to the ACAS surveillance function.

Note 1.— Extended squitters containing position report information will be disseminated for display in connection with an extended squitter application.

Note 2.— Use of the conventional MTL for the ACAS surveillance function preserves the current operation of ACAS surveillance when operating with a receiver with an improved MTL.

4.5.2.3 *Dual or re-triggerable reply processor.* The ACAS Mode S reply processing function shall:

- a) use separate reply processors for Mode S reply formats received at or above the conventional MTL and a separate reply processor for Mode S reply formats received below the conventional MTL; or,
- b) use a Mode S reply processor that will re-trigger if it detects a Mode S preamble that is 2 to 3 dB stronger than the reply that is currently being processed.

Note.— Care must be taken to ensure that low-level squitters (i.e. those below the conventional MTL) do not interfere with the processing of acquisition squitters for ACAS. This could happen if the low-level squitter is allowed to capture the reply processor. This can be prevented by using a separate reply processor for each function, or by requiring the reply processor to be re-triggered by a higher level squitter.

CHAPTER 5. MODE S EXTENDED SQUITTER

Note 1.— A functional model of Mode S extended squitter systems supporting ADS-B and/or TIS-B is depicted in Figure 5-1.

Note 2.— Airborne systems transmit ADS-B messages (ADS-B OUT) and may also receive ADS-B and TIS-B messages (ADS-B IN and TIS-B IN). Ground systems (i.e. ground stations) transmit TIS-B (as an option) and receive ADS-B messages.

Note 3.— Although not explicitly depicted in the functional model presented in Figure 5-1, extended squitter systems installed on aerodrome surface vehicles or fixed obstacles may transmit ADS-B messages (ADS-B OUT).

5.1 MODE S EXTENDED SQUITTER TRANSMITTING SYSTEM CHARACTERISTICS

Note.— Many of the requirements associated with the transmission of Mode S extended squitter are included in Chapter 2 and Chapter 3 for Mode S transponder and non-transponder devices using the message formats defined in the Technical Provisions for Mode S Services and Extended Squitter (Doc 9871). The provisions presented within the following subsections are focused on requirements applicable to specific classes of airborne and ground transmitting systems that are supporting the applications of ADS-B and TIS-B.

5.1.1 ADS-B out requirements

5.1.1.1 Aircraft, surface vehicles and fixed obstacles supporting an ADS-B capability shall incorporate the ADS-B message generation function and the ADS-B message exchange function (transmit) as depicted in Figure 5-1.

5.1.1.1.1 ADS-B transmissions from aircraft shall include position, aircraft identification and type, airborne velocity, periodic status and event driven messages including emergency/priority information.

5.1.1.1.2 **Recommendation.**— *Extended squitter transmitting equipment should use formats and protocols of the latest version available.*

Note 1.— The data formats and protocols for messages transferred via extended squitter are specified in the Technical Provisions for Mode S Services and Extended Squitter (Doc 9871).

Note 2.— Some States and/or regions require extended squitter version 2 to be transmitted by specific dates.

5.1.1.2 *Extended squitter ADS-B transmission requirements.* Mode S extended squitter transmitting equipment shall be classified according to the unit's range capability and the set of parameters that it is capable of transmitting consistent with the following definition of general equipment classes and the specific equipment classes defined in Tables 5-1 and 5-2:

- a) Class A extended squitter airborne systems support an interactive capability incorporating both an extended squitter transmission capability (i.e. ADS-B OUT) with a complementary extended squitter reception capability (i.e. ADS-B IN) in support of onboard ADS-B applications;

- b) Class B extended squitter systems provide a transmission only (i.e. ADS-B OUT without an extended squitter reception capability) for use on aircraft, surface vehicles, or fixed obstructions; and
- c) Class C extended squitter systems have only a reception capability and thus have no transmission requirements.

5.1.1.3 *Class A extended squitter system requirements.* Class A extended squitter airborne systems shall have transmitting and receiving subsystem characteristics of the same class (i.e. A0, A1, A2, or A3) as specified in 5.1.1.1 and 5.2.1.2.

Note.— Class A transmitting and receiving subsystems of the same specific class (e.g. Class A2) are designed to complement each other with their functional and performance capabilities. The minimum air-to-air range that extended squitter transmitting and receiving systems of the same class are designed to support are:

- a) *A0-to-A0 nominal air-to-air range is 10 NM;*
- b) *A1-to-A1 nominal air-to-air range is 20 NM;*
- c) *A2-to-A2 nominal air-to-air range is 40 NM; and*
- d) *A3-to-A3 nominal air-to-air range is 90 NM.*

The above ranges are design objectives and the actual effective air-to-air range of the Class A extended squitter systems may be larger in some cases (e.g. in environments with low levels of 1 090 MHz fruit) and shorter in other cases (e.g. in environments with very high levels of 1 090 MHz fruit).

5.1.1.4 CONTROL OF ADS-B OUT OPERATION

5.1.1.4.1 **Recommendation.**— *Protection against reception of corrupted data from the source providing the position should be satisfied by error detection on the data inputs and the appropriate maintenance of the installation.*

5.1.1.4.2 If an independent control of the ADS-B OUT function is provided, then the operational state of the ADS-B OUT function shall be indicated to the flight crew, at all times.

Note.— There is no requirement for an independent control for the ADS-B OUT function.

5.1.2 TIS-B out requirements

5.1.2.1 Ground stations supporting a TIS-B capability shall incorporate the TIS-B message generation function and the TIS-B message exchange function (transmit).

5.1.2.2 The extended squitter messages for TIS-B shall be transmitted by an extended squitter ground station when connected to an appropriate source of surveillance data.

Note 1.— Extended squitter messages for TIS-B are specified in the Technical Provisions for Mode S Services and Extended Squitter (Doc 9871).

Note 2.— Ground stations supporting TIS-B use an extended squitter transmission capability. The characteristics of such ground stations, in terms of transmitter power, antenna gain, transmission rates, etc., are to be tailored to the desired TIS-B service volume of the specific ground station assuming airborne users are equipped with (at least) Class A1 receiving systems.

5.1.2.3 **Recommendation.**— *The maximum transmission rates and effective radiated power of the transmissions should be controlled to avoid unacceptable levels of RF interference to other 1 090 MHz systems (i.e. SSR and ACAS).*

5.1.3 ADS-B OUT requirements for surface vehicles

5.1.3.1 All surface vehicles supporting any versions of extended squitter ADS-B capability shall transmit extended squitter messages as per 5.1.1.2.

5.1.3.2 *Extended squitter version 2 required system performance.* The position source and equipment installed in surface vehicles to transmit extended squitter version 2 messages shall support the following performance characteristics:

5.1.3.2.1 The NAC_P for the navigation position data shall be greater than or equal to 9, a 95 per cent accuracy bound on horizontal position less than 30 metres.

Note.— NAC_P is calculated based on satellite performance.

5.1.3.2.2 The NAC_V for the navigation velocity data shall be greater than or equal to 2, a velocity error less than 3 metres per second.

5.1.3.2.3 The NAC_P and NAC_V minimum values shall be met at a minimum availability of 95 per cent.

5.1.3.2.4 The system design assurance parameter shall be equal to 1 or more, which defines the probability of a failure resulting in transmission of false or misleading information to be less than or equal to 1×10^{-3} .

Note 1.— *These minimum performance requirements for extended squitter version 2 transmitted position data from surface vehicles are necessary to support aircraft-based alerting applications.*

Note 2.— *Guidance material for implementation of surface vehicle ADS-B systems is contained in the Technical Provisions for Mode S Services and Extended Squitter (Doc 9871).*

5.2 MODE S EXTENDED SQUITTER RECEIVING SYSTEM CHARACTERISTICS (ADS-B IN AND TIS-B IN)

Note 1.— *The paragraphs herein describe the required capabilities for 1 090 MHz receivers used for the reception of Mode S extended squitter transmissions that convey ADS-B and/or TIS-B messages. Airborne receiving systems support ADS-B and TIS-B reception while ground receiving systems support only ADS-B reception.*

Note 2.— *Detailed technical provisions for Mode S extended squitter receivers can be found within RTCA DO-260B/EUROCAE ED-102A, “Minimum Operational Performance Standards for 1 090 MHz Extended Squitter Automatic Dependent Surveillance – Broadcast (ADS-B) and Traffic Information Services – Broadcast (TIS B).”*

5.2.1 Mode S extended squitter receiving system functional requirements

5.2.1.1 Mode S extended squitter receiving systems shall perform the message exchange function (receive) and the report assembler function.

Note.— The extended squitter receiving system receives ADS-B Mode S extended squitter messages and outputs ADS-B reports to client applications. Airborne receiving systems also receive TIS-B extended squitter messages and output TIS-B reports to client applications. This functional model (shown in Figure 5-1) depicts both airborne and ground 1 090 MHz ADS-B receiving systems.

5.2.1.2 *Mode S extended squitter receiver classes.* The required functionality and performance characteristics for the Mode S extended squitter receiving system will vary depending on the ADS-B and TIS-B client applications to be supported and the operational use of the system. Airborne Mode S extended squitter receivers shall be consistent with the definition of receiving system classes shown in Table 5-3.

Note.— Different equipment classes of Mode S extended squitter installations are possible. The characteristics of the receiver associated with a given equipment class are intended to be appropriate to support the required level of operational capability. Equipment classes A0 through A3 are applicable to those Mode S extended airborne installations that include a Mode S extended squitter transmission (ADS OUT) and reception (ADS-B IN) capability. Equipment classes B0 through B3 are applicable to Mode S extended installations with only a transmission (ADS-B OUT) capability and includes equipment classes applicable to airborne, surface vehicles and fixed obstructions. Equipment classes C1 through C3 are applicable to Mode S extended squitter ground receiving systems.

5.2.2 Message exchange function

5.2.2.1 The message exchange function shall include the 1 090 MHz receiving antenna and the radio equipment (receiver/demodulator/decoder/data buffer) sub-functions.

5.2.2.2 *Message exchange functional characteristics.* The airborne Mode S extended squitter receiving system shall support the reception and decoding of all extended squitter messages as listed in Table 5-3. The ground ADS-B extended squitter receiving system shall, as a minimum, support the reception and decoding of all of the extended squitter message types that convey information needed to support the generation of the ADS-B reports of the types required by the client ATM ground applications.

5.2.2.3 *Required message reception performance.* The airborne Mode S extended squitter receiver/demodulation/decoder shall employ the reception techniques and have a receiver minimum trigger threshold level (MTL) as listed in Table 5-3 as a function of the airborne receiver class. The reception technique and MTL for extended squitter ground receiver shall be selected to provide the reception performance (i.e. range and update rates) as required by the client ATM ground applications.

5.2.2.4 *Enhanced reception techniques.* Class A1, A2 and A3 airborne receiving systems shall include the following features to provide improved probability of Mode S extended squitter reception in the presence of multiple overlapping Mode A/C fruit and/or in the presence of an overlapping stronger Mode S fruit, as compared to the performance of the standard reception technique required for Class A0 airborne receiving systems:

- a) Improved Mode S extended squitter preamble detection.
- b) Enhanced error detection and correction.
- c) Enhanced bit and confidence declaration techniques applied to the airborne receiver classes as shown below:
 - 1) Class A1 — Performance equivalent to or better than the use of the “Centre Amplitude” technique.
 - 2) Class A2 — Performance equivalent to or better than the use of the “Multiple Amplitude Samples” baseline technique, where at least 8 samples are taken for each Mode S bit position and are used in the decision process.

- 3) Class A3 — Performance equivalent to or better than the use of the “Multiple Amplitude Samples” baseline technique, where at least 10 samples are taken for each Mode S bit position and are used in the decision process.

Note 1.— The above enhanced reception techniques are as defined in RTCA DO-260B/EUROCAE ED-102A, Appendix I.

Note 2.— The performance provided for each of the above enhanced reception techniques when used in a high fruit environment (i.e. with multiple overlapping Mode A/C fruit) is expected to be at least equivalent to that provided by the use of the techniques described in RTCA DO-260B/EUROCAE ED-102A, Appendix I.

Note 3.— It is considered appropriate for ground extended squitter receiving systems to employ the enhanced reception techniques equivalent to those specified for airborne Class A2 or A3 receiving systems.

5.2.3 Report assembler function

5.2.3.1 The report assembler function shall include the message decoding, report assembly, and output interface sub-functions.

5.2.3.2 When an extended squitter message is received, the message shall be decoded and the applicable ADS-B report(s) of the types defined in 5.2.3.3 shall be generated within 0.5 seconds.

Note 1.— Two configurations of extended squitter airborne receiving systems, which include the reception portion of the ADS-B message exchange function and the ADS-B/TIS-B report assembly function, are allowed:

- a) *Type I extended squitter receiving systems receive ADS-B and TIS-B messages and produce application-specific subsets of ADS-B and TIS-B reports. Type I extended squitter receiving systems are customized to the particular client applications using ADS-B and TIS-B reports. Type I extended squitter receiving systems may additionally be controlled by an external entity to produce installation-defined subsets of the reports that those systems are capable of producing.*
- b) *Type II extended squitter receiving systems receive ADS-B and TIS-B messages and are capable of producing complete ADS-B and TIS-B reports in accordance with the equipment class. Type II extended squitter receiving systems may be controlled by an external entity to produce installation-defined subsets of the reports that those systems are capable of producing.*

Note 2.— Extended squitter ground receiving systems receive ADS-B messages and produce either application-specific subsets or complete ADS-B reports based on the needs of the ground service provider, including the client applications to be supported.

Note 3.— The extended squitter message reception function may be physically partitioned into hardware separate from those that implement the report assembly function.

5.2.3.3 ADS-B REPORT TYPES

Note 1.— The ADS-B report refers to the restructuring of ADS-B message data received from Mode S extended squitter broadcasts into various reports that can be used directly by a set of client applications. Five ADS-B report types are defined by the following subparagraphs for output to client applications. Additional information on the ADS-B report contents and the applicable mapping from extended squitter messages to ADS-B reports can be found in the Technical Provisions for Mode S Services and Extended Squitter (Doc 9871) and RTCA DO-260B / EUROCAE ED-102A.

Note 2.— The use of precision (e.g. GNSS UTC measured time) versus non-precision (e.g. internal receiving system clock) time sources as the basis for the reported time of applicability is described in 5.2.3.5.

5.2.3.3.1 *State vector report.* The state vector report shall contain time of applicability, information about an airborne or vehicle's current kinematic state (e.g. position, velocity), as well as a measure of the integrity of the navigation data, based on information received in airborne or ground position, airborne velocity, identification and category, aircraft operational status and target state and status extended squitter messages. Since separate messages are used for position and velocity, the time of applicability shall be reported individually for the position related report parameters and the velocity related report parameters. Also, the state vector report shall include a time of applicability for the estimated position and/or estimated velocity information (i.e. not based on a message with updated position or velocity information) when such estimated position and/or velocity information is included in the state vector report.

Note.— *Specific requirements for the customization of this type of report may vary according to the needs of the client applications of each participant (ground or airborne). The state vector data is the most dynamic of the four ADS-B reports; hence, the applications require frequent updates of the state vector to meet the required accuracy for the operational dynamics of the typical airborne or ground operations of airborne and surface vehicles.*

5.2.3.3.2 *Mode status report.* The mode status report shall contain time of applicability and current operational information about the transmitting participant, including airborne/vehicle address, call sign, ADS-B version number, airborne/vehicle length and width information, state vector quality information, and other information based on information received in aircraft operational status, target state and status, aircraft identification and category, airborne velocity and aircraft status extended squitter messages. Each time that a mode status report is generated, the report assembler function shall update the report time of applicability. Parameters for which valid data is not available shall either be indicated as invalid or omitted from the mode status report.

Note 1.— *Specific requirements for the customization of this type of report may vary according to the needs of the client applications of each participant (ground or airborne).*

Note 2.— *The age of the information being reported within the various data elements of a mode status report may vary as a result of the information having been received within different extended squitter messages at different times.*

5.2.3.3.3 *Air referenced velocity report.* Air referenced velocity reports shall be generated when air referenced velocity information is received in airborne velocity extended squitter messages. The air referenced velocity report shall contain time of applicability, airspeed and heading information. Only certain classes of extended squitter receiving systems, as defined in 5.2.3.5, are required to generate air referenced velocity reports. Each time that an individual mode status report is generated, the report assembly function shall update the report time of applicability.

Note 1.— *The air referenced velocity report contains velocity information that is received in airborne velocity messages along with additional information received in airborne identification and category extended squitter messages. Air referenced velocity reports are not generated when ground referenced velocity information is being received in the airborne velocity extended squitter messages.*

Note 2.— *Specific requirements for the customization of this type of report may vary according to the needs of the client applications of each participant (ground or airborne).*

5.2.3.3.4 *Resolution advisory (RA) report.* The RA report shall contain time of applicability and the contents of an active ACAS resolution advisory (RA) as received in a Type=28 and Subtype=2 extended squitter message.

Note.— *The RA report is only intended to be generated by ground receiving subsystems when supporting a ground ADS-B client application(s) requiring active RA information. An RA report will nominally be generated each time a Type=28, Subtype=2 extended squitter message is received.*

5.2.3.3.5 TARGET STATE REPORT

Note.— The target state report will be generated when information is received in target state and status messages, along with additional information received in airborne identification and category extended squitter messages. The target state and status message is defined in the Technical Provisions for Mode S Services and Extended Squitter (Doc 9871). Specific requirements for the customization of this type of report may vary according to the needs of the client applications of each participant (ground or airborne).

5.2.3.4 TIS-B REPORT TYPES

5.2.3.4.1 As TIS-B messages are received by airborne receiving systems, the information shall be reported to client applications. Each time that an individual TIS-B report is generated, the report assembly function shall update the report time of applicability to the current time.

Note 1.— The TIS-B message formats are defined in the Technical Provisions for Mode S Services and Extended Squitter (Doc 9871).

Note 2.— The TIS-B report refers to the restructuring of TIS-B message data received from ground Mode S extended squitter broadcasts into reports that can be used by a set of client applications. Two ADS-B report types are defined by the following subparagraphs for output to client applications. Additional information on the TIS-B report contents and the applicable mapping from extended squitter messages to ADS-B reports can be found in the Technical Provisions for Mode S Services and Extended Squitter (Doc 9871).

Note 3.— The use of precision (e.g. GNSS UTC measured time) versus non-precision (e.g. internal receiving system clock) time sources as the basis for the reported time of applicability is described in 5.2.3.5.

5.2.3.4.2 *TIS-B target report.* All received information elements, other than position, shall be reported directly, including all reserved fields for the TIS-B fine format messages and the entire message content of any received TIS-B management message. The reporting format is not specified in detail, except that the information content reported shall be the same as the information content received.

5.2.3.4.3 When a TIS-B position message is received, it is compared with tracks to determine whether it can be decoded into target position (i.e. correlated to an existing track). If the message is decoded into target position, a report shall be generated within 0.5 seconds. The report shall contain the received position information with a time of applicability, the most recently received velocity measurement with a time of applicability, the estimated position and velocity applicable to a common time of applicability, airborne/vehicle address, and all other information in the received message. The estimated values shall be based on the received position information and the track history of the target.

5.2.3.4.4 When a TIS-B velocity message is received, if it is correlated to a complete track, a report shall be generated, within 0.5 seconds of the message reception. The report shall contain the received velocity information with a time of applicability, the estimated position and velocity applicable to a common time of applicability, airborne/vehicle address, and all other information in the received message. The estimated values shall be based on the received ground reference velocity information and the track history of the target.

5.2.3.4.5 *TIS-B management report.* The entire message content of any received TIS-B management message shall be reported directly to the client applications. The information content reported shall be the same as the information content received.

5.2.3.4.5.1 The contents of any received TIS-B management message shall be reported bit-for-bit to the client applications.

5.2.3.5 REPORT TIME OF APPLICABILITY

The receiving system shall use a local source of reference time as the basis for reporting the time of applicability, as defined for each specific ADS-B and TIS-B report type (see 5.2.3.3 and 5.2.3.4).

5.2.3.5.1 *Precision time reference.* Receiving systems intended to generate ADS-B and/or TIS-B reports based on the reception of surface position messages, airborne position messages, and/or TIS-B messages shall use GNSS UTC measured time for the purpose of generating the report time applicability for the following cases of received messages:

- a) version zero (0) ADS-B messages, as defined in 3.1.2.8.6.2, when the navigation uncertainty category (NUC) is 8 or 9; or
- b) version one (1) or version two (2) ADS-B or TIS-B messages, as defined in 3.1.2.8.6.2 and 3.1.2.8.7 respectively, when the navigation integrity category (NIC) is 10 or 11;

UTC measured time data shall have a minimum range of 300 seconds and a resolution of 0.0078125 (1/128) seconds.

5.2.3.5.2 NON-PRECISION LOCAL TIME REFERENCE

5.2.3.5.2.1 For receiving systems not intended to generate ADS-B and/or TIS-B reports based on reception of ADS-B or TIS-B messages meeting the NUC or NIC criteria as indicated in 5.2.3.5.1, a non-precision time source shall be allowed. In such cases, where there is no appropriate precision time source available, the receiving system shall establish an appropriate internal clock or counter having a maximum clock cycle or count time of 20 milliseconds. The established cycle or clock count shall have a minimum range of 300 seconds and a resolution of 0.0078125 (1/128) seconds.

Note.— The use of a non-precision time reference as described above is intended to allow the report time of applicability to accurately reflect the time intervals applicable to reports within a sequence. For example the applicable time interval between state vector reports could be accurately determined by a client application, even though the absolute time (e.g. UTC measured time) would not be indicated by the report.

5.2.3.6 REPORTING REQUIREMENTS

5.2.3.6.1 *Reporting requirements for Type I Mode S extended squitter airborne receiving systems.* As a minimum, the report assembler function associated with Type I Mode S extended squitter receiving systems, as defined in 5.2.3, shall support that subset of ADS-B and TIS-B reports and report parameters, that are required by the specific client applications being served by that receiving system.

5.2.3.6.2 *Reporting requirements for Type II Mode S extended squitter airborne receiving systems.* The report assembler function associated with Type II receiving systems, as defined in 5.2.3, shall generate ADS-B and TIS-B reports according to the class of the receiving system as shown in Table 5-4 when the prerequisite ADS-B and/or TIS-B messages are being received.

5.2.3.6.3 *Reporting requirements for Mode S extended squitter ground receiving systems.* As a minimum, the report assembler function associated with Mode S extended squitter ground receiving systems, as defined in 5.2.3, shall support that subset of ADS-B reports and report parameters, that are required by the specific client applications being served by that receiving system.

5.2.4 Interoperability

The Mode S extended squitter receiving system shall provide interoperability between the different versions of extended squitter ADS-B message formats.

Note 1.— All defined ADS-B versions and their corresponding message formats are contained in the Technical Provisions for Mode S Services and Extended Squitter (Doc 9871) and are identified by a version number.

Note 2.— ADS-B message formats are defined with backward compatibility with previous versions. An extended squitter receiver can recognize and decode signals of its own version, as well as the message formats from lower versions. The receiver, however, can decode the portion of messages received from a higher version transponder according to its own capability.

5.2.4.1 INITIAL MESSAGE DECODING

The Mode S extended squitter receiving system shall, upon acquiring a new ADS-B target, initially apply the decoding provisions applicable to version 0 (zero) ADS B messages until or unless an aircraft operational status message is received indicating that a higher version message format is in use.

5.2.4.2 APPLYING VERSION NUMBER

The Mode S extended squitter receiving system shall decode the version number information conveyed in the aircraft operational status message and shall apply the corresponding decoding rules for the reported version, up to the highest version supported by the receiving system, for the decoding of the subsequent extended squitter ADS-B messages from that specific aircraft or vehicle.

5.2.4.3 HANDLING OF RESERVED MESSAGE SUBFIELDS

The Mode S extended squitter receiving system shall ignore the contents of any message subfield defined as reserved.

Note.— This provision supports interoperability between message versions by allowing the definition of additional parameters that will be ignored by earlier receiver versions and correctly decoded by newer receiver versions.

TABLES FOR CHAPTER 5

Table 5-1. ADS-B Class A equipment characteristics

<i>Equipment class</i>	<i>Minimum transmit power (at antenna terminal)</i>	<i>Maximum transmit power (at antenna terminal)</i>	<i>Airborne or surface</i>	<i>Minimum extended squitter message capability required (see Note 2)</i>
A0 (Minimum)	18.5 dBW (see Note 1)	27 dBW	Airborne	Airborne position Aircraft identification and category Airborne velocity Aircraft operational status Extended squitter aircraft status
			Surface	Surface position Aircraft identification and category Aircraft operational status Extended squitter aircraft status
A1 (Basic)	21 dBW	27 dBW	Airborne	Airborne position Aircraft identification and category Airborne velocity Aircraft operational status Extended squitter aircraft status
			Surface	Surface position Aircraft identification and category Aircraft operational status Extended squitter aircraft status
A2 (Enhanced)	21 dBW	27 dBW	Airborne	Airborne position Aircraft identification and category Airborne velocity Aircraft operational status Extended squitter aircraft status Target state and status
			Surface	Surface position Aircraft identification and category Aircraft operational status Extended squitter aircraft status
A3 (Extended)	23 dBW	27 dBW	Airborne	Airborne position Aircraft identification and category Airborne velocity Aircraft operational status Extended squitter aircraft status Target state and status
			Surface	Surface position Aircraft identification and category Aircraft operational status Extended squitter aircraft status
<p><i>Note 1.— See Chapter 3, 3.1.2.10.2 for restrictions on the use of this category of Mode S transponder.</i></p> <p><i>Note 2.— The extended squitter messages applicable to Class A equipment are defined in the Technical Provisions for Mode S Services and Extended Squitter (Doc 9871).</i></p>				

Table 5-2. ADS-B Class B equipment characteristics

<i>Equipment class</i>	<i>Minimum transmit power (at antenna terminal)</i>	<i>Maximum transmit power (at antenna terminal)</i>	<i>Airborne or surface</i>	<i>Minimum extended squitter message capability required</i>
B0 (Airborne)	18.5 dBW (see Note 1)	27 dBW	Airborne	Airborne position Aircraft identification and category Airborne velocity Aircraft operational status Extended squitter aircraft status
			Surface	Surface position Aircraft identification and category Aircraft operational status Extended squitter aircraft status
B1 (Airborne)	21 dBW	27 dBW	Airborne	Airborne position Aircraft identification and category Airborne velocity Aircraft operational status Extended squitter aircraft status
			Surface	Surface position Aircraft identification and category Aircraft operational status Extended squitter aircraft status
B2 Low (Ground Vehicle)	8.5 dBW	< 18.5 dBW (see Note 2)	Surface	Surface position Aircraft identification and category Aircraft operational status
B2 (Ground Vehicle)	18.5 dBW	27 dBW (see Note 2)	Surface	Surface position Aircraft identification and category Aircraft operational status
B3 (Fixed Obstacle)	18.5 dBW	27 dBW (see Note 2)	Airborne (see Note 3)	Airborne position Aircraft identification and category Aircraft operational status
<p><i>Note 1.— See Chapter 3, 3.1.2.10.2 for restrictions on the use of this category of Mode S transponder.</i></p> <p><i>Note 2.— The appropriate ATS authority is expected to get the maximum power level permitted.</i></p> <p><i>Note 3.— Fixed obstacles use the airborne ADS-B message formats since knowledge of their location is of primary interest to airborne aircraft.</i></p>				

Table 5-3. Reception performance for airborne receiving systems

Receiver class	Intended air-to-air operational range	Receiver minimum trigger threshold level (MTL) (see Note 1)	Reception Technique (see Note 2)	Required extended squitter ADS-B message support	Required extended squitter TIS-B message support
A0 (Basic VFR)	10 NM	−72 dBm	Standard	Airborne position Surface position Airborne velocity Aircraft identification and category Extended squitter airborne status Aircraft operational status	Fine airborne position Coarse airborne position Fine surface position Aircraft identification and category Airborne velocity Management
A1 (Basic IFR)	20 NM	−79 dBm	Enhanced	Airborne position Surface position Airborne velocity Aircraft identification and category Extended squitter airborne status Aircraft operational status	Fine airborne position Coarse airborne position Fine surface position Aircraft identification and category Airborne velocity Management
A2 (Enhanced IFR)	40 NM	−79 dBm	Enhanced	Airborne position Surface position Airborne velocity Aircraft identification and category Extended squitter airborne status Aircraft operational status Target state and status	Fine airborne position Coarse airborne position Fine surface position Aircraft identification and category Airborne velocity Management
A3 (Extended capability)	90 NM	−84 dBm (and −87 dBm at 15% probability of reception)	Enhanced	Airborne position Surface position Airborne velocity Aircraft identification and category Extended squitter airborne status Aircraft operational status Target state and status	Fine airborne position Coarse airborne position Fine surface position Aircraft identification and category Airborne velocity Management
<p><i>Note 1.— Specific MTL is referenced to the signal level at the output terminal of the antenna, assuming a passive antenna. If electronic amplification is integrated into the antenna assembly, then the MTL is referenced at the input to the amplifier. For Class A3 receivers, a second performance level is defined at a received signal level of −87 dBm where 15 per cent of the messages are to be successfully received. MTL values refer to reception under non-interference conditions.</i></p> <p><i>Note 2.— The extended squitter receiver reception techniques are defined in 5.2.2.4. “Standard” reception techniques refer to the baseline techniques, as required for ACAS 1 090 MHz receivers, that are intended to handle single overlapping Mode A/C fruit. “Enhanced” reception techniques refer to techniques intended to provide improved reception performance in the presence of multiple overlapping Mode A/C fruit and improved decoder re-triggering in the presence of overlapping stronger Mode S fruit. The requirements for the enhanced reception techniques that are applicable to the specific airborne receiver classes are defined in 5.2.2.4.</i></p>					

Table 5-4. Mode S extended squitter airborne receiving system reporting requirements

<i>Receiver class</i>	<i>Minimum ADS-B reporting requirements</i>	<i>Minimum TIS-B reporting requirements</i>
A0 (Basic VFR)	ADS-B state vector report (per 5.2.3.3.1) and ADS-B mode status report (per 5.2.3.3.2)	TIS-B state report and TIS-B management report
A1 (Basic IFR)	ADS-B state vector report (per 5.2.3.3.1) and ADS-B mode status report (per 5.2.3.3.2) and ADS-B air referenced velocity report (ARV) (per 5.2.3.3.3)	TIS-B state report and TIS-B management report
A2 (Enhanced IFR)	ADS-B state vector report (per 5.2.3.3.1) and ADS-B mode status report (per 5.2.3.3.2) and ADS-B ARV report (per 5.2.3.3.3) and ADS-B target state report (per 5.2.3.3.5)	TIS-B state report and TIS-B management report
A3 (Extended capability)	ADS-B state vector report (per 5.2.3.3.1) and ADS-B mode status report (per 5.2.3.3.2) and ADS-B ARV report (per 5.2.3.3.3) and ADS-B target state report (per 5.2.3.3.5)	TIS-B state report and TIS-B management report

FIGURE FOR CHAPTER 5

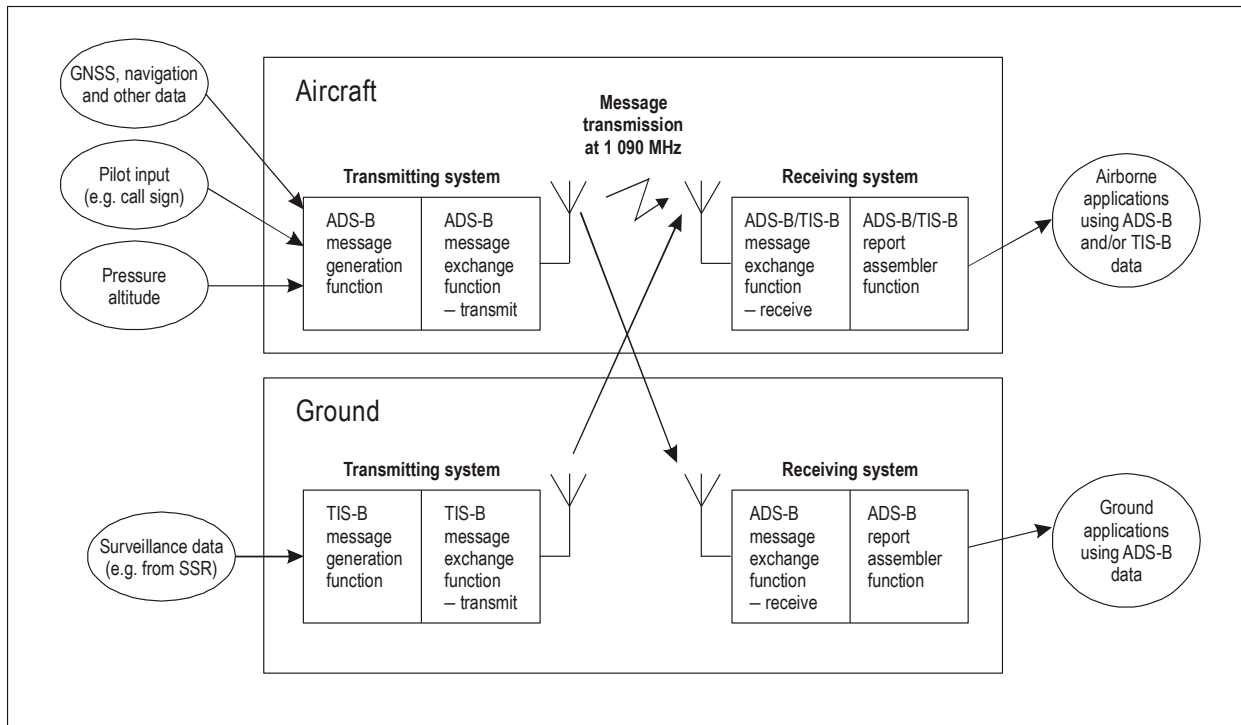

Figure 5-1. ADS-B/TIS-B system functional model

CHAPTER 6. MULTILATERATION SYSTEMS

Note 1.— Multilateration (MLAT) systems use the time difference of arrival (TDOA) of the transmissions of an SSR transponder (or the extended squitter transmissions of a non-transponder device) between several ground receivers to determine the position of the aircraft (or ground vehicle). A multilateration system can be:

- a) passive, using transponder replies to other interrogations or spontaneous squitter transmissions;*
- b) active, in which case the system itself interrogates aircraft in the coverage area; or*
- c) a combination of a) and b).*

Note 2.— Detailed technical guidance for MLAT and WAM can be found in the Aeronautical Surveillance Manual (Doc 9924), Appendix L. Material contained in EUROCAE ED-117A – MOPS for Mode S Multilateration Systems for Use in A-SMGCS and ED-142 – Technical Specifications for Wide Area Multilateration System (WAM) provides information for planning, implementation and satisfactory operation of MLAT systems for most applications.

6.1 DEFINITIONS

Multilateration (MLAT) System. A group of equipment configured to provide position derived from the secondary surveillance radar (SSR) transponder signals (replies or squitters) primarily using time difference of arrival (TDOA) techniques. Additional information, including identification, can be extracted from the received signals.

Time Difference of Arrival (TDOA). The difference in relative time that a transponder signal from the same aircraft (or ground vehicle) is received at different receivers.

Wide area multilateration (WAM) system. A multilateration system deployed to support en-route surveillance, terminal area surveillance and other applications such as height monitoring and precision runway monitoring (PRM).

6.2 FUNCTIONAL REQUIREMENTS

6.2.1 Radio frequency characteristics, structure and data contents of signals used in 1 090 MHz MLAT systems shall conform to the provisions of Chapter 3.

6.2.2 An MLAT system used for air traffic surveillance shall be capable of determining aircraft position and identity.

Note 1.— Depending on the application, either two- or three-dimensional position of the aircraft may be required.

Note 2.— Aircraft identity may be determined from:

- a) Mode A code contained in Mode A or Mode S replies; or*
- b) Aircraft identification contained in Mode S replies or extended squitter identity and category message.*

Note 3.— Other aircraft information can be obtained by analysing transmissions of opportunity (i.e. squitters or replies to other ground interrogations) or by direct interrogation by the MLAT system.

6.2.3 Where an MLAT system is equipped to decode additional position information contained in transmissions, it shall report such information separately from the aircraft position calculated based on TDOA.

6.3 PROTECTION OF THE RADIO FREQUENCY ENVIRONMENT

Note.— This section only applies to active MLAT systems.

6.3.1 In order to minimize system interferences the effective radiated power of active interrogators shall be reduced to the lowest value consistent with the operationally required range of each individual interrogator site.

Note.— Guidance material on power consideration is contained in the Aeronautical Surveillance Manual (Doc 9924).

6.3.2 An active MLAT system shall not use active interrogations to obtain information that can be obtained by passive reception within each required update period.

Note.— Transponder occupancy will be increased by the use of omnidirectional antennas. It is particularly significant for Mode S selective interrogations because of their higher transmission rate. All Mode S transponders will be occupied decoding each selective interrogation not just the addressed transponder.

6.3.3 An active MLAT system consisting of a set of transmitters shall be considered as a single Mode S interrogator.

6.3.4 The set of transmitters used by all active MLAT systems in any part of the airspace shall not cause any transponder to be impacted such that its occupancy, because of the aggregate of all MLAT 1 030 MHz interrogations, is greater than 2 per cent at any time.

Note 1.— This represents a minimum requirement. Some regions may impose stricter requirements.

Note 2.— For an MLAT system using only Mode S interrogations, 2 per cent is equivalent to no more than 400 Mode S interrogations per second received by any aircraft from all systems using MLAT technology.

6.3.5 Active MLAT systems shall not use Mode S All-Call interrogations.

Note.— Mode S aircraft can be acquired by the reception of acquisition squitter or extended squitter even in airspace where there are no active interrogators.

6.4 PERFORMANCE REQUIREMENTS

6.4.1 The performance characteristics of the MLAT system used for air traffic surveillance shall be such that the intended operational service(s) can be satisfactorily supported.

CHAPTER 7. TECHNICAL REQUIREMENTS FOR AIRBORNE SURVEILLANCE APPLICATIONS

Note 1.— Airborne surveillance applications are based on aircraft receiving and using ADS-B message information transmitted by other aircraft/vehicles or ground stations. The capability of an aircraft to receive and use ADS-B/TIS-B message information is referred to as ADS-B/TIS-B IN.

Note 2.— Initial airborne surveillance applications use ADS-B messages on 1 090 MHz extended squitter to provide airborne traffic situational awareness (ATSA) and are expected to include “In-trail procedures” and “Enhanced visual separation on approach”.

Note 3.— Detailed description of aforementioned applications can be found in RTCA/DO-289 and DO-312.

7.1 GENERAL REQUIREMENTS

7.1.1 Traffic data functions

Note.— The aircraft transmitting ADS-B messages used by other aircraft for airborne surveillance applications is referred to as the reference aircraft.

7.1.1.1 IDENTIFYING THE REFERENCE AIRCRAFT

7.1.1.1.1 The system shall support a function to identify unambiguously each reference aircraft relevant to the application.

7.1.1.2 TRACKING THE REFERENCE AIRCRAFT

7.1.1.2.1 The system shall support a function to monitor the movements and behaviour of each reference aircraft relevant to the application.

7.1.1.3 TRAJECTORY OF THE REFERENCE AIRCRAFT

7.1.1.3.1 **Recommendation.**— *The system should support a computational function to predict the future position of a reference aircraft beyond simple extrapolation.*

Note.— It is anticipated that this function will be required for future applications.

7.1.2 Displaying traffic

Note.— Provisions contained in this section apply to cases wherein tracks generated by ACAS and by reception of ADS-B/TIS-B IN messages are shown on a single display.

7.1.2.1 The system shall display only one track for each distinct aircraft on a given display.

Note.— This is to ensure that tracks established by ACAS and ADS-B/TIS-B IN are properly correlated and mutually validated before being displayed.

7.1.2.2 Where a track generated by ADS-B/TIS-B IN and a track generated by ACAS have been determined to belong to the same aircraft, the track generated by ADS-B/TIS-B IN shall be displayed.

Note.— At close distances, it is possible that the track generated by ACAS provides better accuracy than the track generated by ADS-B/TIS-B IN. The requirement above ensures the continuity of the display.

7.1.2.3 The display of the tracks shall comply with the requirements of ACAS traffic display.

Note.— Section 4.3 addresses colour coding and readability of the display.

— END —

ISBN 978-92-9265-730-7



9 789292 657307