

International Standards
and Recommended Practices



Annex 10
to the Convention on
International Civil Aviation

Aeronautical Telecommunications

Volume III
Communication Systems
(Part I — Digital Data Communication Systems
Part II — Voice Communication Systems)

This edition incorporates all amendments adopted by the Council prior to 27 February 2007 and supersedes, on 22 November 2007, all previous editions of Annex 10, Volume III.

For information regarding the applicability of the Standards and Recommended Practices, see Foreword.

Second Edition
July 2007

International Civil Aviation Organization

**International Standards
and Recommended Practices**



**Annex 10
to the Convention on
International Civil Aviation**

Aeronautical Telecommunications

**Volume III
Communication Systems**
(Part I — Digital Data Communication Systems
Part II — Voice Communication Systems)

This edition incorporates all amendments adopted by the Council prior to 27 February 2007 and supersedes, on 22 November 2007, all previous editions of Annex 10, Volume III.

For information regarding the applicability of the Standards and Recommended Practices, see Foreword.

Second Edition
July 2007

International Civil Aviation Organization

TABLE OF CONTENTS

	<i>Page</i>
FOREWORD	(vii)
PART I — DIGITAL DATA COMMUNICATION SYSTEMS	
CHAPTER 1. Definitions	I-1-1
CHAPTER 2. General	I-2-1
(to be developed)	
CHAPTER 3. Aeronautical Telecommunication Network	I-3-1
3.1 Definitions	I-3-1
3.2 Introduction	I-3-1
3.3 General	I-3-2
3.4 General requirements.....	I-3-2
3.5 ATN applications requirements	I-3-3
3.6 ATN communication service requirements	I-3-4
3.7 ATN naming and addressing requirements.....	I-3-5
3.8 ATN security requirements.....	I-3-5
Tables for Chapter 3	I-3-6
Figure for Chapter 3	I-3-8
CHAPTER 4. Aeronautical Mobile-Satellite (Route) Service (AMS(R)S).....	I-4-1
4.1 Definitions	I-4-1
4.2 General	I-4-2
4.3 RF characteristics.....	I-4-2
4.4 Priority and pre-emptive access	I-4-3
4.5 Signal acquisition and tracking.....	I-4-3
4.6 Performance requirements	I-4-4
4.7 System interfaces	I-4-7
CHAPTER 5. SSR Mode S Air-Ground Data Link.....	I-5-1
5.1 Definitions relating to the Mode S subnetwork	I-5-1
5.2 Mode S characteristics	I-5-4
5.3 DCE and XDCE state tables	I-5-45
5.4 Mode S packet formats	I-5-46
Tables for Chapter 5	I-5-48
Figures for Chapter 5.....	I-5-70

	<i>Page</i>
CHAPTER 6. VHF Air-Ground Digital Link (VDL)	I-6-1
6.1 Definitions and system capabilities	I-6-1
6.2 System characteristics of the ground installation.....	I-6-4
6.3 System characteristics of the aircraft installation	I-6-5
6.4 Physical layer protocols and services	I-6-7
6.5 Link layer protocols and services	I-6-16
6.6 Subnetwork layer protocols and services.....	I-6-17
6.7 The VDL mobile subnetwork dependent convergence function (SNDCF)	I-6-18
6.8 Voice unit for Mode 3.....	I-6-19
6.9 VDL Mode 4.....	I-6-19
Tables for Chapter 6	I-6-26
Figures for Chapter 6.....	I-6-28
Appendix to Chapter 6. References	I-6-30
CHAPTER 7. Aeronautical Mobile Airport Communications System (AeroMACS)	I-7-1
7.1 Definitions	I-7-1
7.2 Introduction	I-7-2
7.3 General	I-7-2
7.4 Radio frequency (RF) characteristics.....	I-7-3
7.5 Performance requirements	I-7-6
7.6 System interfaces	I-7-8
7.7 Application requirements.....	I-7-8
CHAPTER 8. AFTN Network	I-8-1
8.1 Definitions	I-8-1
8.2 Technical provisions relating to teletypewriter apparatus and circuits used in the AFTN.....	I-8-2
8.3 Terminal equipment associated with aeronautical radioteletypewriter channels operating in the band 2.5 – 30 MHz	I-8-3
8.4 Characteristics of interregional AFS circuits.....	I-8-3
8.5 Technical provisions relating to ATS message transmission.....	I-8-4
8.6 Technical provisions relating to international ground-ground data interchange at medium and higher signalling rates	I-8-4
Tables for Chapter 8	I-8-25
Figures for Chapter 8.....	I-8-34
CHAPTER 9. Aircraft Addressing System.....	I-9-1
Appendix to Chapter 9. A Worldwide Scheme for the Allocation, Assignment and Application of Aircraft Addresses.....	I-9-2
1. General	I-9-2
2. Description of the scheme	I-9-2
3. Management of the scheme	I-9-2
4. Allocation of aircraft addresses	I-9-2
5. Assignment of aircraft addresses	I-9-3
6. Application of aircraft addresses	I-9-3

	<i>Page</i>
7. Administration of the temporary aircraft address assignments	I-9-4
Table 9-1. Allocation of aircraft addresses to States	I-9-5
CHAPTER 10. Point-to-Multipoint Communications.....	I-10-1
10.1 Service via satellite for the dissemination of aeronautical information	I-10-1
10.2 Service via satellite for the dissemination of WAFS products	I-10-1
CHAPTER 11. HF Data Link.....	I-11-1
11.1 Definitions and system capabilities	I-11-1
11.2 HF data link system	I-11-2
11.3 HF data link protocol.....	I-11-3
11.4 Ground management subsystem	I-11-10
Tables for Chapter 11	I-11-11
Figure for Chapter 11	I-11-13
CHAPTER 12. Universal Access Transceiver (UAT).....	I-12-1
12.1 Definitions and overall system characteristics.....	I-12-1
12.2 System characteristics of the ground installation.....	I-12-4
12.3 System characteristics of the aircraft installation	I-12-4
12.4 Physical layer characteristics.....	I-12-7
12.5 Guidance material.....	I-12-11
Tables for Chapter 12	I-12-12
Figures for Chapter 12.....	I-12-14

PART II — VOICE COMMUNICATION SYSTEMS

CHAPTER 1. Definitions	II-1-1
CHAPTER 2. Aeronautical Mobile Service	II-2-1
2.1 Air-ground VHF communication system characteristics.....	II-2-1
2.2 System characteristics of the ground installation.....	II-2-1
2.3 System characteristics of the airborne installation.....	II-2-3
2.4 Single sideband (SSB) HF communication system characteristics for use in the aeronautical mobile service	II-2-5
2.5 Satellite voice communication (SATVOICE) system characteristics.....	II-2-9
Table for Chapter 2.....	II-2-10
Figures for Chapter 2.....	II-2-11
CHAPTER 3. SELCAL System.....	II-3-1

	<i>Page</i>
CHAPTER 4. Aeronautical Speech Circuits	II-4-1
4.1 Technical provisions relating to international aeronautical speech circuit switching and signalling for ground-ground applications	II-4-1
CHAPTER 5. Emergency Locator Transmitter (ELT) for Search and Rescue.....	II-5-1
5.1 General	II-5-1
5.2 Specification for the 121.5 MHz component of emergency locator transmitter (ELT) for search and rescue	II-5-2
5.3 Specification for the 406 MHz component of emergency locator transmitter (ELT) for search and rescue	II-5-3
Appendix to Chapter 5. Emergency Locator Transmitter Coding	II-5-4
1. General	II-5-4
2. ELT coding	II-5-4

ATTACHMENTS

Attachment to Part I — Guidance material for the VHF digital link (VDL)	ATT I-1
1. Guidance material for the VHF digital link (VDL)	ATT I-1
2. System description.....	ATT I-1
3. VDL principles	ATT I-1
3.1 Communications transfer principles.....	ATT I-1
3.2 VDL quality of service for ATN routing.....	ATT I-2
4. VDL ground station network concept.....	ATT I-2
4.1 Access	ATT I-2
4.2 Institutional issues concerning VDL ground station network operators.....	ATT I-3
4.3 VDL ground station equipment.....	ATT I-3
4.4 Ground station siting	ATT I-3
4.5 Ground station frequency engineering	ATT I-4
4.6 Ground station connection to intermediate systems	ATT I-4
5. VDL airborne operating concept	ATT I-5
5.1 Avionics	ATT I-5
5.2 VDL avionics certification	ATT I-5
5.3 Registration of aircraft with VDL network operators	ATT I-5
Figure for Attachment to Part I.....	ATT I-6
Attachment to Part II — Guidance material for communication systems.....	ATT II-1
1. VHF communications	ATT II-1
1.1 Audio characteristics of VHF communication equipment	ATT II-1
1.2 Off-set carrier system in 25 kHz, 50 kHz and 100 kHz spaced channels.....	ATT II-1
1.3 Immunity performance of COM receiving systems in the presence of VHF FM broadcast interference.....	ATT II-2
2. SELCAL system	ATT II-2

FOREWORD

Historical background

Standards and Recommended Practices for Aeronautical Telecommunications were first adopted by the Council on 30 May 1949 pursuant to the provisions of Article 37 of the Convention on International Civil Aviation (Chicago 1944) and designated as Annex 10 to the Convention. They became effective on 1 March 1950. The Standards and Recommended Practices were based on recommendations of the Communications Division at its Third Session in January 1949.

Up to and including the Seventh Edition, Annex 10 was published in one volume containing four Parts together with associated attachments: Part I — Equipment and Systems, Part II — Radio Frequencies, Part III — Procedures, and Part IV — Codes and Abbreviations.

By Amendment 42, Part IV was deleted from the Annex; the codes and abbreviations contained in that Part were transferred to a new document, Doc 8400.

As a result of the adoption of Amendment 44 on 31 May 1965, the Seventh Edition of Annex 10 was replaced by two volumes: Volume I (First Edition) containing Part I — Equipment and Systems, and Part II — Radio Frequencies, and Volume II (First Edition) containing Communication Procedures.

As a result of the adoption of Amendment 70 on 20 March 1995, Annex 10 was restructured to include five volumes: Volume I — Radio Navigation Aids; Volume II — Communication Procedures; Volume III — Communication Systems; Volume IV — Surveillance Radar and Collision Avoidance Systems; and Volume V — Aeronautical Radio Frequency Spectrum Utilization. By Amendment 70, Volumes III and IV were published in 1995 and Volume V was planned for publication with Amendment 71.

Table A shows the origin of Annex 10, Volume III subsequent to Amendment 70, together with a summary of the principal subjects involved and the dates on which the Annex and the amendments were adopted by Council, when they became effective and when they became applicable.

Action by Contracting States

Notification of differences. The attention of Contracting States is drawn to the obligation imposed by Article 38 of the Convention by which Contracting States are required to notify the Organization of any differences between their national regulations and practices and the International Standards contained in this Annex and any amendments thereto. Contracting States are invited to extend such notification to any differences from the Recommended Practices contained in this Annex and any amendments thereto, when the notification of such differences is important for the safety of air navigation. Further, Contracting States are invited to keep the Organization currently informed of any differences which may subsequently occur, or of the withdrawal of any differences previously notified. A specific request for notification of differences will be sent to Contracting States immediately after the adoption of each amendment to this Annex.

The attention of States is also drawn to the provisions of Annex 15 related to the publication of differences between their national regulations and practices and the related ICAO Standards and Recommended Practices through the Aeronautical Information Service, in addition to the obligation of States under Article 38 of the Convention.

Promulgation of information. The establishment and withdrawal of and changes to facilities, services and procedures affecting aircraft operations provided in accordance with the Standards, Recommended Practices and Procedures specified in Annex 10 should be notified and take effect in accordance with the provisions of Annex 15.

Use of the text of the Annex in national regulations. The Council, on 13 April 1948, adopted a resolution inviting the attention of Contracting States to the desirability of using in their own national regulations, as far as practicable, the precise language of those ICAO Standards that are of a regulatory character and also of indicating departures from the Standards, including any additional national regulations that were important for the safety or regularity of air navigation. Wherever possible, the provisions of this Annex have been deliberately written in such a way as would facilitate incorporation, without major textual changes, into national legislation.

Status of Annex components

An Annex is made up of the following component parts, not all of which, however, are necessarily found in every Annex; they have the status indicated:

1.— *Material comprising the Annex proper:*

- a) *Standards and Recommended Practices* adopted by the Council under the provisions of the Convention. They are defined as follows:

Standard: Any specification for physical characteristics, configuration, matériel, performance, personnel or procedure, the uniform application of which is recognized as necessary for the safety or regularity of international air navigation and to which Contracting States will conform in accordance with the Convention; in the event of impossibility of compliance, notification to the Council is compulsory under Article 38.

Recommended Practice: Any specification for physical characteristics, configuration, matériel, performance, personnel or procedure, the uniform application of which is recognized as desirable in the interest of safety, regularity or efficiency of international air navigation, and to which Contracting States will endeavour to conform in accordance with the Convention.

- b) *Appendices* comprising material grouped separately for convenience but forming part of the Standards and Recommended Practices adopted by the Council.
- c) *Definitions* of terms used in the Standards and Recommended Practices which are not self-explanatory in that they do not have accepted dictionary meanings. A definition does not have independent status but is an essential part of each Standard and Recommended Practice in which the term is used, since a change in the meaning of the term would affect the specification.
- d) *Tables and Figures* which add to or illustrate a Standard or Recommended Practice and which are referred to therein, form part of the associated Standard or Recommended Practice and have the same status.

2.— *Material approved by the Council for publication in association with the Standards and Recommended Practices:*

- a) *Forewords* comprising historical and explanatory material based on the action of the Council and including an explanation of the obligations of States with regard to the application of the Standards and Recommended Practices ensuing from the Convention and the Resolution of Adoption;
- b) *Introductions* comprising explanatory material introduced at the beginning of parts, chapters or sections of the Annex to assist in the understanding of the application of the text;

- c) *Notes* included in the text, where appropriate, to give factual information or references bearing on the Standards or Recommended Practices in question, but not constituting part of the Standards or Recommended Practices;
- d) *Attachments* comprising material supplementary to the Standards and Recommended Practices, or included as a guide to their application.

Disclaimer regarding patents

Attention is drawn to the possibility that certain elements of Standards and Recommended Practices in this Annex may be the subject of patents or other intellectual property rights. ICAO shall not be responsible or liable for not identifying any or all such rights. ICAO takes no position regarding the existence, validity, scope or applicability of any claimed patents or other intellectual property rights, and accepts no responsibility or liability therefore or relating thereto.

Selection of language

This Annex has been adopted in four languages — English, French, Russian and Spanish. Each Contracting State is requested to select one of those texts for the purpose of national implementation and for other effects provided for in the Convention, either through direct use or through translation into its own national language, and to notify the Organization accordingly.

Editorial practices

The following practice has been adhered to in order to indicate at a glance the status of each statement: *Standards* have been printed in light face roman; *Recommended Practices* have been printed in light face italics, the status being indicated by the prefix Recommendation; *Notes* have been printed in light face italics, the status being indicated by the prefix *Note*.

The following editorial practice has been followed in the writing of specifications: for Standards the operative verb “shall” is used, and for Recommended Practices the operative verb “should” is used.

The units of measurement used in this document are in accordance with the International System of Units (SI) as specified in Annex 5 to the Convention on International Civil Aviation. Where Annex 5 permits the use of non-SI alternative units these are shown in parentheses following the basic units. Where two sets of units are quoted it must not be assumed that the pairs of values are equal and interchangeable. It may, however, be inferred that an equivalent level of safety is achieved when either set of units is used exclusively.

Any reference to a portion of this document, which is identified by a number and/or title, includes all subdivisions of that portion.

Table A. Amendments to Annex 10, Volume III

<i>Amendment</i>	<i>Source(s)</i>	<i>Subject(s)</i>	<i>Adopted Effective Applicable</i>
70	Air Navigation Commission, Third Meeting of the Aeronautical Mobile Communications Panel (AMCP)	Introduction of new Volume III and SARPs related to the Aeronautical Mobile-Satellite Service (AMSS)	20 March 1995 24 July 1995 9 November 1995
71	Air Navigation Commission; SP COM/OPS/95 Divisional Meeting (1995); fifth meeting of the Secondary Surveillance Radar Improvements and Collision Avoidance Systems Panel (SICASP); third meeting of the Aeronautical Mobile Communications Panel (AMCP)	Addition of specifications for the Mode S subnetwork of ATN; addition of material relating to the introduction of 8.33 kHz channel spacing; changes to material related to the protection of air-ground communications in the VHF band; addition of technical specifications relating to the RF characteristics for the VHF digital link (VDL).	12 March 1996 15 July 1996 7 November 1996
72	Air Navigation Commission; fourth meeting of the Aeronautical Mobile Communications Panel (AMCP)	Introduction of SARPs and guidance material for VHF digital link (VDL); definition for VDL and deletion of obsolete material on air/ground data interchange.	12 March 1997 21 July 1997 6 November 1997
73	Air Navigation Commission; second meeting of the Aeronautical Telecommunication Network Panel (ATNP); sixth meeting of the Secondary Surveillance Radar Improvements and Collision Avoidance Systems Panel (SICASP)	Introduction of material relating to the ATN; changes to specifications of the Mode S subnetwork.	19 March 1998 20 July 1998 5 November 1998
74	Fifth meeting of the Aeronautical Mobile Communications Panel (AMCP); Air Navigation Commission	Introduction of: a) specifications for HF data link; and b) changes to the specifications for emergency locator transmitters.	18 March 1999 19 July 1999 4 November 1999
75	Sixth meeting of the Aeronautical Mobile Communications Panel (AMCP); Air Navigation Commission	Changes to the AMSS SARPs introducing a new antenna type, a new voice channel type and enhanced provisions for interoperability among AMSS systems; changes to the VDL SARPs to reduce potential interference to current VHF voice communication systems caused by VDL transmitters; changes to the VHF voice communication SARPs to enhance immunity to interference from VDL transmitters on board the same aircraft.	13 March 2000 17 July 2000 2 November 2000
76	Third meeting of the Aeronautical Telecommunication Network Panel (ATNP); seventh meeting of the Aeronautical Mobile Communications Panel (AMCP); the Secretariat assisted by the ATS Voice Switching and Signalling Study Group (AVSSSG)	Aeronautical telecommunication network (ATN) system management, security and directory services; removal of detailed material relating to CIDIN; integrated voice and data link system (VDL Mode 3); data link satisfying surveillance applications (VDL Mode 4); deletion of all the provisions for VDL Mode 1; removal of the detailed technical specifications for VDL Mode 2; aeronautical speech circuits; update of references to the ITU Radio Regulations.	12 March 2001 16 July 2001 1 November 2001

<i>Amendment</i>	<i>Source(s)</i>	<i>Subject(s)</i>	<i>Adopted Effective Applicable</i>
77	Secondary Surveillance Radar Improvements and Collision Avoidance Systems Panel (SICASP)	Mode S subnetwork (Part I), aircraft addressing system (Part I).	27 February 2002 15 July 2002 28 November 2002
78	Air Navigation Commission	Changes to technical specifications relating to radio frequency channels; introduction of registration requirement for ELTs; incorporation of VDL Modes 3 and 4 in the table of ATN subnetwork priorities (Table 3-3); editorial amendments.	5 March 2003 14 July 2003 27 November 2003
79	Eighth meeting of the Aeronautical Mobile Communications Panel (AMCP)	Changes to technical specifications relating to high frequency data link (HF DL) to align them with relevant provisions of ITU RR; introduction of FM immunity characteristics for VDL Mode 4; deletion of the note indicating that VDL Mode 4 SARPs apply to surveillance applications.	23 February 2004 12 July 2004 25 November 2004
80	Air Navigation Commission	Provisions for the location protocols for use in emergency locator transmitters (ELTs) operating on the 406 MHz frequency.	25 February 2005 11 July 2005 24 November 2005
81	—	No change.	—
82 (2nd edition)	Aeronautical Communications Panel (ACP); Surveillance and Conflict Resolution Systems Panel (SCRSP); Operational Data Link Panel (OPLINKP)	Updating ATN provisions on AMHS; revision of AMS(R)S SARPs; introduction of UAT; updating of material on SSR Mode S data link and use of Mode S extended squitter for ADS-B; relocation of Mode S and extended squitter ADS-B data formats to separate manuals.	26 February 2007 16 July 2007 22 November 2007
83	Aeronautical Communications Panel (ACP)	The introduction of Internet Protocol Suite (IPS) technology to the aeronautical telecommunication network (ATN) and introduction of provisions for 8.33 kHz offset carrier systems in the very high frequency (VHF) double sideband-amplitude modulation (DSB-AM).	10 March 2008 20 July 2008 20 November 2008
84	—	No change.	—
85	Aeronautical Surveillance Panel (ASP)	Improvement of the procedure for the allocation of 24-bit addresses to States and updating the table of allocations.	26 February 2010 12 July 2010 18 November 2010
86	—	No change.	—
87	—	No change.	—
88-A	Aeronautical Communications Panel (ACP)	a) Alignment of VDL SARPs, mainly to reflect recent updates to the ITU Radio Regulations; b) Provisions added to encourage implementation of ATN/IPS, while indicating that ATN/OSI remains a supported Standard.	26 February 2013 15 July 2013 14 November 2013
88-B	—	No change.	—
89	—	No change.	—

<i>Amendment</i>	<i>Source(s)</i>	<i>Subject(s)</i>	<i>Adopted Effective Applicable</i>
90	First meeting of the Communications Panel (CP/1) and the Secretariat; second meeting of the Operational Data Link Panel (OPLINKP/2)	a) introduction of the aeronautical mobile airport communications system (AeroMACS); and b) new section on satellite voice communications (SATVOICE).	22 February 2016 11 July 2016 10 November 2016
91	Second meeting of the Communications Panel Data Communications Infrastructure Working Group (CP-DCIWG/2).	Amendment concerning the selective calling system (SELCAL).	6 November 2020 22 March 2021 3 November 2022

INTERNATIONAL STANDARDS AND RECOMMENDED PRACTICES

PART I — DIGITAL DATA COMMUNICATION SYSTEMS

CHAPTER 1. DEFINITIONS

Note 1.— All references to “Radio Regulations” are to the Radio Regulations published by the International Telecommunication Union (ITU). Radio Regulations are amended from time to time by the decisions embodied in the Final Acts of World Radiocommunication Conferences held normally every two to three years. Further information on the ITU processes as they relate to aeronautical radio system frequency use is contained in the Handbook on Radio Frequency Spectrum Requirements for Civil Aviation including statement of approved ICAO policies (Doc 9718).

Note 2.— This Part of Annex 10 includes Standards and Recommended Practices for certain forms of equipment for communication systems. While the Contracting State will determine the necessity for specific installations in accordance with the conditions prescribed in the relevant Standard or Recommended Practice, review of the need for specific installation and the formulation of ICAO opinion and recommendations to Contracting States concerned, is carried out periodically by Council, ordinarily on the basis of recommendations of Regional Air Navigation Meetings (Doc 8144, Directives to Regional Air Navigation Meetings and Rules of Procedure for their Conduct).

Note 3.— This chapter contains general definitions relevant to communication systems. Definitions specific to each of the systems included in this volume are contained in the relevant chapters.

Note 4.— Material on secondary power supply and guidance material concerning reliability and availability for communication systems is contained in Annex 10, Volume I, 2.9 and Volume I, Attachment F, respectively.

Aeronautical administrative communications (AAC). Communications necessary for the exchange of aeronautical administrative messages.

Aeronautical operational control (AOC). Communication required for the exercise of authority over the initiation, continuation, diversion or termination of flight for safety, regularity and efficiency reasons.

Aeronautical telecommunication network (ATN). A global internetwork architecture that allows ground, air-ground and avionic data subnetworks to exchange digital data for the safety of air navigation and for the regular, efficient and economic operation of air traffic services.

Aircraft address. A unique combination of twenty-four bits available for assignment to an aircraft for the purpose of air-ground communications, navigation and surveillance.

Aircraft earth station (AES). A mobile earth station in the aeronautical mobile-satellite service located on board an aircraft (see also “GES”).

Air traffic service. A generic term meaning variously, flight information service, alerting service, air traffic advisory service, air traffic control service (area control service, approach control service or aerodrome control service).

Automatic dependent surveillance — contract (ADS-C). A means by which the terms of an ADS-C agreement will be exchanged between the ground system and the aircraft, via a data link, specifying under what conditions ADS-C reports would be initiated, and what data would be contained in the reports.

Automatic terminal information service (ATIS). The automatic provision of current, routine information to arriving and departing aircraft throughout 24 hours or a specified portion thereof.

Data link-automatic terminal information service (D-ATIS). The provision of ATIS via data link.

Voice-automatic terminal information service (Voice-ATIS). The provision of ATIS by means of continuous and repetitive voice broadcasts.

Bit error rate (BER). The number of bit errors in a sample divided by the total number of bits in the sample, generally averaged over many such samples.

Carrier-to-multipath ratio (C/M). The ratio of the carrier power received directly, i.e. without reflection, to the multipath power, i.e. carrier power received via reflection.

Carrier-to-noise density ratio (C/N_o). The ratio of the total carrier power to the average noise power in a 1 Hz bandwidth, usually expressed in dBHz.

Channel rate. The rate at which bits are transmitted over the RF channel. These bits include those bits used for framing and error correction, as well as the information bits. For burst transmission, the channel rate refers to the instantaneous burst rate over the period of the burst.

Channel rate accuracy. This is relative accuracy of the clock to which the transmitted channel bits are synchronized. For example, at a channel rate of 1.2 kbits/s, maximum error of one part in 10^6 implies the maximum allowed error in the clock is $\pm 1.2 \times 10^{-3}$ Hz.

Circuit mode. A configuration of the communications network which gives the appearance to the application of a dedicated transmission path.

Controller pilot data link communications (CPDLC). A means of communication between controller and pilot, using data link for ATC communications.

Data link flight information services (D-FIS). The provision of FIS via data link.

Doppler shift. The frequency shift observed at a receiver due to any relative motion between transmitter and receiver.

End-to-end. Pertaining or relating to an entire communication path, typically from (1) the interface between the information source and the communication system at the transmitting end to (2) the interface between the communication system and the information user or processor or application at the receiving end.

End-user. An ultimate source and/or consumer of information.

Energy per symbol to noise density ratio (E_s/N_o). The ratio of the average energy transmitted per channel symbol to the average noise power in a 1 Hz bandwidth, usually expressed in dB. For A-BPSK and A-QPSK, one channel symbol refers to one channel bit.

Equivalent isotropically radiated power (e.i.r.p.). The product of the power supplied to the antenna and the antenna gain in a given direction relative to an isotropic antenna (*absolute or isotropic gain*).

Flight information service (FIS). A service provided for the purpose of giving advice and information useful for the safe and efficient conduct of flights.

Forward error correction (FEC). The process of adding redundant information to the transmitted signal in a manner which allows correction, at the receiver, of errors incurred in the transmission.

Gain-to-noise temperature ratio. The ratio, usually expressed in dB/K, of the antenna gain to the noise at the receiver output of the antenna subsystem. The noise is expressed as the temperature that a 1 ohm resistor must be raised to produce the same noise power density.

Ground earth station (GES). An earth station in the fixed satellite service, or, in some cases, in the aeronautical mobile-satellite service, located at a specified fixed point on land to provide a feeder link for the aeronautical mobile-satellite service.

Note.— This definition is used in the ITU's Radio Regulations under the term "aeronautical earth station". The definition herein as "GES" for use in the SARPs is to clearly distinguish it from an aircraft earth station (AES), which is a mobile station on an aircraft.

Mode S subnetwork. A means of performing an interchange of digital data through the use of secondary surveillance radar (SSR) Mode S interrogators and transponders in accordance with defined protocols.

Point-to-point. Pertaining or relating to the interconnection of two devices, particularly end-user instruments. A communication path of service intended to connect two discrete end-users; as distinguished from broadcast or multipoint service.

Slotted aloha. A random access strategy whereby multiple users access the same communications channel independently, but each communication must be confined to a fixed time slot. The same timing slot structure is known to all users, but there is no other coordination between the users.

Time division multiple access (TDMA). A multiple access scheme based on time-shared use of an RF channel employing: (1) discrete contiguous time slots as the fundamental shared resource; and (2) a set of operating protocols that allows users to interact with a master control station to mediate access to the channel.

Time division multiplex (TDM). A channel sharing strategy in which packets of information from the same source but with different destinations are sequenced in time on the same channel.

Transit delay. In packet data systems, the elapsed time between a request to transmit an assembled data packet and an indication at the receiving end that the corresponding packet has been received and is ready to be used or forwarded.

VHF digital link (VDL). A constituent mobile subnetwork of the aeronautical telecommunication network (ATN), operating in the aeronautical mobile VHF frequency band. In addition, the VDL may provide non-ATN functions such as, for instance, digitized voice.

CHAPTER 2. GENERAL

[to be developed]

CHAPTER 3. AERONAUTICAL TELECOMMUNICATION NETWORK

Note 1.— Detailed technical specifications for ATN/OSI applications are contained in the Manual on Detailed Technical Specifications for the Aeronautical Telecommunication Network (ATN) using ISO/OSI Standards and Protocols (Doc 9880) and in the Manual of Technical Provisions for the Aeronautical Telecommunication Network (ATN) (Doc 9705).

Note 2.— Detailed technical specifications for ATN/IPS applications are contained in the Manual for the Aeronautical Telecommunication Network (ATN) using Internet Protocol Suite (IPS) Standards and Protocols (Doc 9896) (available electronically on the ICAO-Net).

3.1 DEFINITIONS

Application entity (AE). An AE represents a set of ISO/OSI communication capabilities of a particular application process (see ISO/IEC 9545 for further details).

ATN security services. A set of information security provisions allowing the receiving end system or intermediate system to unambiguously identify (i.e. authenticate) the source of the received information and to verify the integrity of that information.

ATS interfacility data communication (AIDC). Automated data exchange between air traffic services units in support of flight notification, flight coordination, transfer of control and transfer of communication.

ATS message handling service (ATSMHS). An ATN application consisting of procedures used to exchange ATS messages in store-and-forward mode over the ATN such that the conveyance of an ATS message is in general not correlated with the conveyance of another ATS message by the service provider.

ATS message handling system (AMHS). The set of computing and communication resources implemented by ATS organizations to provide the ATS message handling service.

Authorized path. A communication path suitable for a given message category.

Data link initiation capability (DLIC). A data link application that provides the ability to exchange addresses, names and version numbers necessary to initiate data link applications (see Doc 4444).

Directory service (DIR). A service, based on the ITU-T X.500 series of recommendations, providing access to and management of structured information relevant to the operation of the ATN and its users.

Required communication performance (RCP). A statement of the performance requirements for operational communication in support of specific ATM functions (see *Manual on Required Communication Performance (RCP)* (Doc 9869)).

3.2 INTRODUCTION

3.2.1 The ATN is specifically and exclusively intended to provide digital data communications services to air traffic service provider organizations and aircraft operating agencies in support of:

- a) air traffic services communications (ATSC) with aircraft;
- b) air traffic services communications between ATS units;
- c) aeronautical operational control communications (AOC); and
- d) aeronautical administrative communications (AAC).

3.3 GENERAL

Note — The Standards and Recommended Practices in sections 3.4 to 3.8 define the minimum required protocols and services that will enable the global implementation of the aeronautical telecommunication network (ATN).

3.3.1 ATN communication services shall support ATN applications.

3.3.2 Requirements for implementation of the ATN shall be made on the basis of regional air navigation agreements. These agreements shall specify the area in which the communication standards for the ATN/OSI or the ATN/IPS are applicable.

3.4 GENERAL REQUIREMENTS

3.4.1 The ATN shall either use International Organization for Standardization (ISO) communication standards for open systems interconnection (OSI) or use the Internet Society (ISOC) communications standards for the Internet Protocol Suite (IPS).

Note 1.— ATN/IPS implementation is preferred for ground-ground networks. While ATN/OSI continues to be supported in air-ground networks, particularly when using VDL Mode 2, it is expected that future air-ground implementations will use the ATN/IPS.

Note 2.— Interoperability between interconnecting OSI/IPS networks is expected to be arranged prior to implementation.

Note 3.— Guidance material on interoperability between ATN/OSI and ATN/IPS is contained in Doc 9896.

3.4.2 The AFTN/AMHS gateway shall ensure the interoperability of AFTN and CIDIN stations and networks with the ATN.

3.4.3 An authorized path(s) shall be defined on the basis of a predefined routing policy.

3.4.4 The ATN shall transmit, relay and deliver messages in accordance with the priority classifications and without discrimination or undue delay.

3.4.5 The ATN shall provide means to define data communications that can be carried only over authorized paths for the traffic type and category specified by the user.

3.4.6 The ATN shall provide communication in accordance with the prescribed required communication performance (RCP).

Note.— The Manual on Required Communication Performance (RCP) (Doc 9869) contains the necessary information on RCP.

3.4.7 The ATN shall operate in accordance with the communication priorities defined in Table 3-1* and Table 3-2.

3.4.8 The ATN shall enable exchange of application information when one or more authorized paths exist.

3.4.9 The ATN shall notify the appropriate application processes when no authorized path exists.

3.4.10 The ATN shall make provisions for the efficient use of limited bandwidth subnetworks.

3.4.11 **Recommendation.**— *The ATN should enable an aircraft intermediate system (router) to connect to a ground intermediate system (router) via different subnetworks.*

3.4.12 **Recommendation.**— *The ATN should enable an aircraft intermediate system (router) to connect to different ground intermediate systems (routers).*

3.4.13 The ATN shall enable the exchange of address information between applications.

3.4.14 Where the absolute time of day is used within the ATN, it shall be accurate to within 1 second of coordinated universal time (UTC).

Note.— *The time accuracy value results in synchronization errors of up to two seconds.*

3.5 ATN APPLICATIONS REQUIREMENTS

3.5.1 System applications

Note.— *System applications provide services that are necessary for operation of the ATN.*

3.5.1.1 The ATN shall support the data link initiation capability (DLIC) applications when air-ground data links are implemented.

Note.— *The Manual of Air Traffic Services Data Link Applications (Doc 9694, Part I) defines the data link initiation capability (DLIC) application.*

3.5.1.2 The ATN/OSI end-system shall support the following directory services (DIR) application functions when AMHS and/or security protocols are implemented:

- a) directory information retrieval; and
- b) directory information modification.

3.5.2 Air-ground applications

3.5.2.1 The ATN shall be capable of supporting one or more of the following applications:

- a) ADS-C;

* Tables 3-1 and 3-2 are located at the end of this chapter.

- b) CPDLC; and
- c) FIS (including ATIS and METAR).

Note.— See the Manual of Air Traffic Services Data Link Applications (*Doc 9694*).

3.5.3 Ground-ground applications

3.5.3.1 The ATN shall be capable of supporting the following applications:

- a) ATS interfacility data communication (AIDC); and
- b) ATS message handling services applications (ATSMHS).

Note.— See the Manual of Air Traffic Services Data Link Applications (*Doc 9694*).

3.6 ATN COMMUNICATIONS SERVICE REQUIREMENTS

3.6.1 ATN/IPS upper layer communications service

3.6.1.1 An ATN host* shall be capable of supporting the ATN/IPS upper layers including an application layer.

3.6.2 ATN/OSI upper layer communications service

3.6.2.1 An ATN/OSI end-system (ES)* shall be capable of supporting the OSI upper layer communications service (ULCS) including session, presentation and application layers.

3.6.3 ATN/IPS communications service

3.6.3.1 An ATN host shall be capable of supporting the ATN/IPS including the:

- a) transport layer in accordance with RFC 793 (TCP) and RFC 768 (UDP); and
- b) network layer in accordance with RFC 2460 (IPv6).

3.6.3.2 An IPS router shall support the ATN network layer in accordance with RFC 2460 (IPv6) and RFC 4271 (BGP), and RFC 2858 (BGP multiprotocol extensions).

3.6.4 ATN/OSI communications service

3.6.4.1 An ATN/OSI end-system shall be capable of supporting the ATN including the:

- a) transport layer in accordance with ISO/IEC 8073 (TP4) and optionally ISO/IEC 8602 (CLTP); and
- b) network layer in accordance with ISO/IEC 8473 (CLNP).

* An ATN host is an ATN end-system in OSI terminology; an ATN end-system is an ATN host in IPS terminology.

3.6.4.2 An ATN intermediate system (IS) shall support the ATN network layer in accordance with ISO/IEC 8473 (CLNP) and ISO/IEC 10747 (IDRP).

3.7 ATN NAMING AND ADDRESSING REQUIREMENTS

Note.— The ATN naming and addressing scheme supports the principles of unambiguous identification of intermediate systems (routers) and end-systems (hosts) and provides global address standardization.

3.7.1 The ATN shall provide provisions for unambiguous application identification.

3.7.2 The ATN shall provide provisions for unambiguous addressing.

3.7.3 The ATN shall provide means to unambiguously address all ATN end-systems (hosts) and intermediate systems (routers).

3.7.4 The ATN addressing and naming plans shall allow States and organizations to assign addresses and names within their own administrative domains.

3.8 ATN SECURITY REQUIREMENTS

3.8.1 The ATN shall make provisions whereby only the controlling ATS unit may provide ATC instructions to aircraft operating in its airspace.

Note.— This is achieved through the current and next data authority aspects of the controller-pilot data link communications (CPDLC) application.

3.8.2 The ATN shall enable the recipient of a message to identify the originator of that message.

3.8.3 ATN end-systems supporting ATN security services shall be capable of authenticating the identity of peer end-systems, authenticating the source of messages and ensuring the data integrity of the messages.

Note.— The use of security is the default; however, its implementation is based on local policy.

3.8.4 The ATN services shall be protected against service attacks to a level consistent with the application service requirements.

TABLES FOR CHAPTER 3

Table 3-1. Mapping of ATN communication priorities

Message categories	ATN application	Corresponding protocol priority	
		Transport layer priority	Network layer priority
Network/systems management		0	14
Distress communications		1	13
Urgent communications		2	12
High-priority flight safety messages	CPDLC, ADS-C	3	11
Normal-priority flight safety messages	AIDC, ATIS	4	10
Meteorological communications	METAR	5	9
Flight regularity communications	DLIC, ATSMHS	6	8
Aeronautical information service messages		7	7
Network/systems administration	DIR	8	6
Aeronautical administrative messages		9	5
<unassigned>		10	4
Urgent-priority administrative and U.N. Charter communications		11	3
High-priority administrative and State/Government communications		12	2
Normal-priority administrative communications		13	1
Low-priority administrative communications and aeronautical passenger communications		14	0
<p><i>Note.— The network layer priorities shown in the table apply only to connectionless network priority and do not apply to subnetwork priority.</i></p>			

Table 3-2. Mapping of ATN network priority to mobile subnetwork priority

Message categories	ATN network layer priority	Corresponding mobile subnetwork priority (see Note 4)					
		AMSS	VDL Mode 2	VDL Mode 3	VDL Mode 4	SSR Mode S	HFDL
Network/systems management	14	14	see Note 1	3	14	high	14
Distress communications	13	14	see Note 1	2	13	high	14
Urgent communications	12	14	see Note 1	2	12	high	14
High-priority flight safety messages	11	11	see Note 1	2	11	high	11
Normal-priority flight safety messages	10	11	see Note 1	2	10	high	11
Meteorological communications	9	8	see Note 1	1	9	low	8
Flight regularity communications	8	7	see Note 1	1	8	low	7
Aeronautical information service messages	7	6	see Note 1	0	7	low	6
Network/systems administration	6	5	see Note 1	0	6	low	5
Aeronautical administrative messages	5	5	not allowed	not allowed	not allowed	not allowed	not allowed
<unassigned>	4	unassigned	unassigned	unassigned	unassigned	unassigned	unassigned
Urgent-priority administrative and U.N. Charter communications	3	3	not allowed	not allowed	not allowed	not allowed	not allowed
High-priority administrative and State/Government communications	2	2	not allowed	not allowed	not allowed	not allowed	not allowed
Normal-priority administrative communications	1	1	not allowed	not allowed	not allowed	not allowed	not allowed
Low-priority administrative communications and aeronautical passenger communications	0	0	not allowed	not allowed	not allowed	not allowed	not allowed

Note 1.— VDL Mode 2 has no specific subnetwork priority mechanisms.

Note 2.— The AMSS SARPs specify mapping of message categories to subnetwork priority without explicitly referencing ATN network layer priority.

Note 3.— The term “not allowed” means that only communications related to safety and regularity of flight are authorized to pass over this subnetwork as defined in the subnetwork SARPs.

Note 4.— Only those mobile subnetworks are listed for which subnetwork SARPs exist and for which explicit support is provided by the ATN boundary intermediate system (BIS) technical provisions.

FIGURE FOR CHAPTER 3

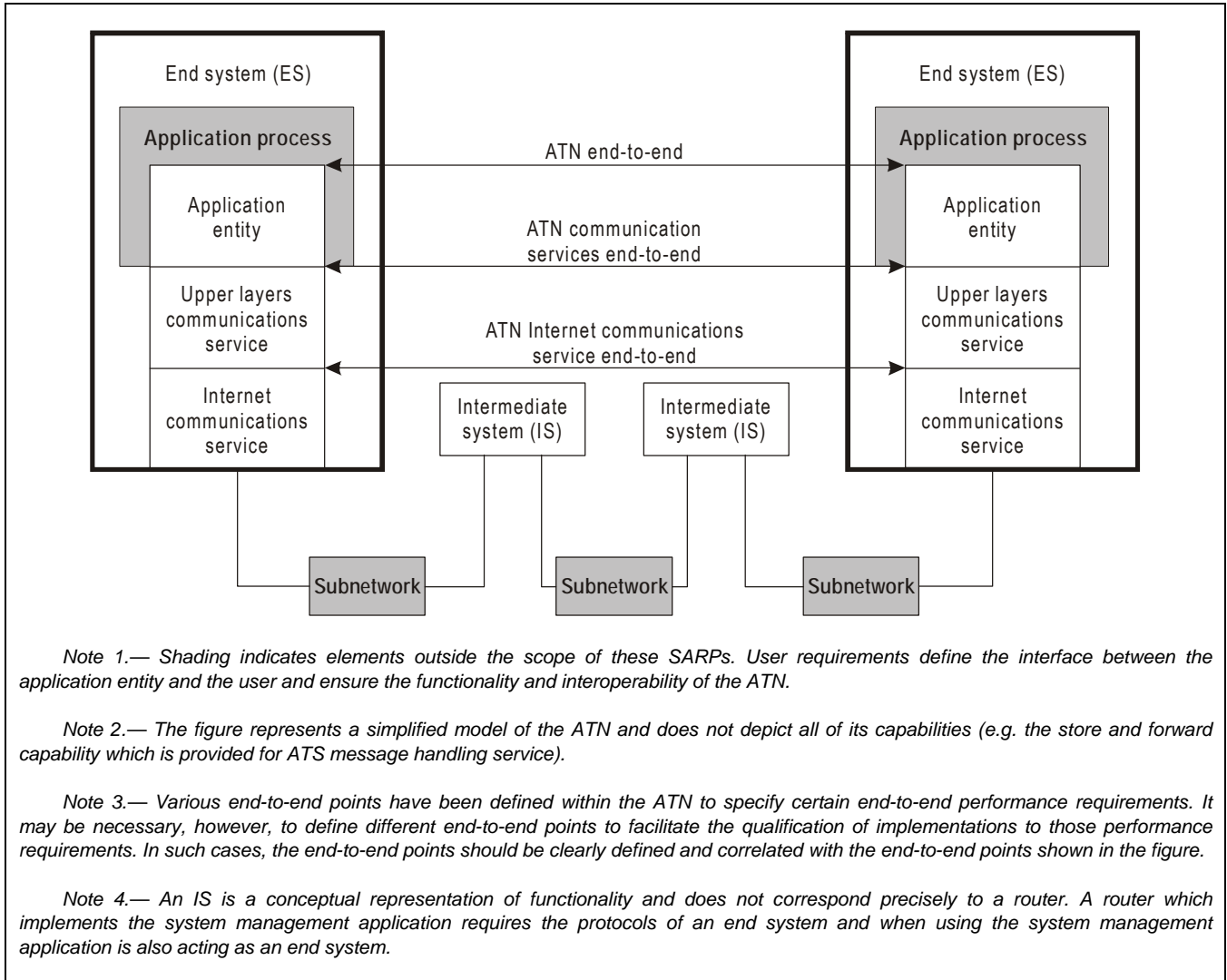

Figure 3-1. Conceptual model of the ATN

CHAPTER 4. AERONAUTICAL MOBILE-SATELLITE (ROUTE) SERVICE (AMS(R)S)

Note 1.— This chapter contains Standards and Recommended Practices applicable to the use of Aeronautical Mobile-Satellite (R) Service communications technologies. The Standards and Recommended Practices in this chapter are service- and performance-oriented and are not tied to a specific technology or technique.

Note 2.— Detailed Technical Specifications of AMS(R)S Systems are contained in the manual on AMS(R)S. This document also provides a detailed description of the AMS(R)S, including details on the Standards and Recommended Practices below.

4.1 DEFINITIONS

Connection establishment delay. Connection establishment delay, as defined in ISO 8348, includes a component, attributable to the called subnetwork (SN) service user, which is the time between the SN-CONNECT indication and the SN-CONNECT response. This user component is due to actions outside the boundaries of the satellite subnetwork and is therefore excluded from the AMS(R)S specifications.

Data transfer delay (95th percentile). The 95th percentile of the statistical distribution of delays for which transit delay is the average.

Data transit delay. In accordance with ISO 8348, the average value of the statistical distribution of data delays. This delay represents the subnetwork delay and does not include the connection establishment delay.

Network (N). The word “network” and its abbreviation “N” in ISO 8348 are replaced by the word “subnetwork” and its abbreviation “SN”, respectively, wherever they appear in relation to the subnetwork layer packet data performance.

Residual error rate. The ratio of incorrect, lost and duplicate subnetwork service data units (SNSDUs) to the total number of SNSDUs that were sent.

Spot beam. Satellite antenna directivity whose main lobe encompasses significantly less than the earth’s surface that is within line-of-sight view of the satellite. May be designed so as to improve system resource efficiency with respect to geographical distribution of user earth stations.

Subnetwork (SN). See *Network (N)*.

Subnetwork service data unit (SNSDU). An amount of subnetwork user data, the identity of which is preserved from one end of a subnetwork connection to the other.

Total voice transfer delay. The elapsed time commencing at the instant that speech is presented to the AES or GES and concluding at the instant that the speech enters the interconnecting network of the counterpart GES or AES. This delay includes vocoder processing time, physical layer delay, RF propagation delay and any other delays within an AMS(R)S subnetwork.

Note.— The following terms used in this chapter are defined in Annex 10 as follows:

- *Aeronautical telecommunication network (ATN): Volume III, Chapter 1.*
- *Aeronautical mobile-satellite (route) service (AMS(R)S): Volume II, Chapter 1.1.*
- *Aircraft earth station (AES): Volume III, Chapter 1.*
- *Ground earth station (GES): Volume III, Chapter 1.*
- *Subnetwork layer: Volume III, Chapter 6.1.*

4.2 GENERAL

4.2.1 Any mobile-satellite system intended to provide AMS(R)S shall conform to the requirements of this chapter.

4.2.1.1 An AMS(R)S system shall support packet data service, or voice service, or both.

4.2.2 Requirements for mandatory carriage of AMS(R)S system equipment including the level of system capability shall be made on the basis of regional air navigation agreements which specify the airspace of operation and the implementation timescales for the carriage of equipment. A level of system capability shall include the performance of the AES, the satellite and the GES.

4.2.3 The agreements indicated in 4.2.2 shall provide at least two years' notice of mandatory carriage of airborne systems.

4.2.4 **Recommendation.**— *Civil aviation authorities should coordinate with national authorities and service providers those implementation aspects of an AMS(R)S system that will permit its worldwide interoperability and optimum use, as appropriate.*

4.3 RF CHARACTERISTICS

4.3.1 Frequency bands

Note.— *ITU Radio Regulations permit systems providing mobile-satellite service to use the same spectrum as AMS(R)S without requiring such systems to offer safety services. This situation has the potential to reduce the spectrum available for AMS(R)S. It is critical that States consider this issue in frequency planning and in the establishment of national or regional spectrum requirements.*

4.3.1.1 When providing AMS(R)S communications, an AMS(R)S system shall operate only in frequency bands which are appropriately allocated to AMS(R)S and protected by the ITU Radio Regulations.

4.3.2 Emissions

4.3.2.1 The total emissions of the AES necessary to meet designed system performance shall be controlled to avoid harmful interference to other systems necessary to support safety and regularity of air navigation, installed on the same or other aircraft.

Note 1.— *Harmful interference can result from radiated and/or conducted emissions that include harmonics, discrete spurious, intermodulation product and noise emissions, and are not necessarily limited to the "transmitter on" state.*

Note 2.— Protection requirements for GNSS are contained in Annex 10, Volume I.

4.3.2.2 INTERFERENCE TO OTHER AMS(R)S EQUIPMENT

4.3.2.2.1 Emissions from an AMS(R)S system AES shall not cause harmful interference to an AES providing AMS(R)S on a different aircraft.

Note.— One method of complying with 4.3.2.2.1 is by limiting emissions in the operating band of other AMS(R)S equipment to a level consistent with the intersystem interference requirements such as contained in RTCA document DO-215. RTCA and EUROCAE may establish new performance standards for future AMS(R)S which may describe methods of compliance with this requirement.

4.3.3 Susceptibility

4.3.3.1 The AES equipment shall operate properly in an interference environment causing a cumulative relative change in its receiver noise temperature ($\Delta T/T$) of 25 per cent.

4.4 PRIORITY AND PRE-EMPTIVE ACCESS

4.4.1 Every aircraft earth station and ground earth station shall be designed to ensure that messages transmitted in accordance with Annex 10, Volume II, 5.1.8, including their order of priority, are not delayed by the transmission and/or reception of other types of messages. If necessary, as a means to comply with the above requirement, message types not defined in Annex 10, Volume II, 5.1.8 shall be terminated even without warning, to allow Annex 10, Volume II, 5.1.8 type messages to be transmitted and received.

4.4.2 All AMS(R)S data packets and all AMS(R)S voice calls shall be identified as to their associated priority.

4.4.3 Within the same message category, the system shall provide voice communications priority over data communications.

4.5 SIGNAL ACQUISITION AND TRACKING

4.5.1 The AES, GES and satellites shall properly acquire and track service link signals when the aircraft is moving at a ground speed of up to 1 500 km/h (800 knots) along any heading.

4.5.1.1 **Recommendation.**— *The AES, GES and satellites should properly acquire and track service link signals when the aircraft is moving at a ground speed of up to 2 800 km/h (1 500 knots) along any heading.*

4.5.2 The AES, GES and satellites shall properly acquire and track service link signals when the component of the aircraft acceleration vector in the plane of the satellite orbit is up to 0.6 g.

4.5.2.1 **Recommendation.**— *The AES, GES and satellites should properly acquire and track service link signals when the component of the aircraft acceleration vector in the plane of the satellite orbit is up to 1.2 g.*

4.6 PERFORMANCE REQUIREMENTS

4.6.1 Designated operational coverage

4.6.1.1 An AMS(R)S system shall provide AMS(R)S throughout its designated operational coverage (DOC).

4.6.2 Failure notification

4.6.2.1 In the event of a service failure, an AMS(R)S system shall provide timely predictions of the time, location and duration of any resultant outages until full service is restored.

Note.— Service outages may, for example, be caused by the failure of a satellite, satellite spot beam, or GES. The geographic areas affected by such outages may be a function of the satellite orbit and system design, and may vary with time.

4.6.2.2 The system shall annunciate a loss of communications capability within 30 seconds of the time when it detects such a loss.

4.6.3 AES requirements

4.6.3.1 The AES shall meet the relevant performance requirements contained in 4.6.4 and 4.6.5 for aircraft in straight and level flight throughout the designated operational coverage of the satellite system.

4.6.3.1.1 **Recommendation.**— *The AES should meet the relevant performance requirements contained in 4.6.4 and 4.6.5 for aircraft attitudes of +20/-5 degrees of pitch and +/-25 degrees of roll throughout the DOC of the satellite system.*

4.6.4 Packet data service performance

4.6.4.1 If the system provides AMS(R)S packet data service, it shall meet the standards of the following subparagraphs.

Note.— System performance standards for packet data service may also be found in RTCA Document DO-270.

4.6.4.1.1 An AMS(R)S system providing a packet data service shall be capable of operating as a constituent mobile subnetwork of the ATN.

Note.— In addition, an AMS(R)S may provide non-ATN data functions.

4.6.4.1.2 DELAY PARAMETERS

Note.— The term “highest priority service” denotes the priority which is reserved for distress, urgency and certain infrequent network system management messages. The term “lowest priority service” denotes the priority used for regularity of flight messages. All delay parameters are under peak-hour traffic loading conditions.

4.6.4.1.2.1 *Connection establishment delay.* Connection establishment delay shall not be greater than 70 seconds.

4.6.4.1.2.1.1 **Recommendation.**— *Connection establishment delay should not be greater than 50 seconds.*

4.6.4.1.2.2 In accordance with ISO 8348, data transit delay values shall be based on a fixed subnetwork service data unit (SNSDU) length of 128 octets. Data transit delays shall be defined as average values.

4.6.4.1.2.3 *Data transit delay, from-aircraft, highest priority.* From-aircraft data transit delay shall not be greater than 40 seconds for the highest priority data service.

4.6.4.1.2.3.1 **Recommendation.**— *Data transit delay, from-aircraft, highest priority. From-aircraft data transit delay should not be greater than 23 seconds for the highest priority data service.*

4.6.4.1.2.3.2 **Recommendation.**— *Data transit delay, from-aircraft, lowest priority. From-aircraft data transit delay should not be greater than 28 seconds for the lowest priority data service.*

4.6.4.1.2.4 *Data transit delay, to-aircraft, highest priority.* To-aircraft data transit delay shall not be greater than 12 seconds for the highest priority data service.

4.6.4.1.2.4.1 **Recommendation.**— *Data transit delay, to-aircraft, lowest priority. To-aircraft data transit delay should not be greater than 28 seconds for the lowest priority data service.*

4.6.4.1.2.5 *Data transfer delay (95th percentile), from-aircraft, highest priority.* From-aircraft data transfer delay (95th percentile), shall not be greater than 80 seconds for the highest priority data service.

4.6.4.1.2.5.1 **Recommendation.**— *Data transfer delay (95th percentile), from-aircraft, highest priority. From-aircraft data transfer delay (95th percentile), should not be greater than 40 seconds for the highest priority data service.*

4.6.4.1.2.5.2 **Recommendation.**— *Data transfer delay (95th percentile), from-aircraft, lowest priority. From-aircraft data transfer delay (95th percentile), should not be greater than 60 seconds for the lowest priority data service.*

4.6.4.1.2.6 *Data transfer delay (95th percentile), to-aircraft, highest priority.* To-aircraft data transfer delay (95th percentile), shall not be greater than 15 seconds for the highest priority data service.

4.6.4.1.2.6.1 **Recommendation.**— *Data transfer delay (95th percentile), to-aircraft, lowest priority. To-aircraft data transfer delay (95th percentile), should not be greater than 30 seconds for the lowest priority data service.*

4.6.4.1.2.7 *Connection release delay (95th percentile).* The connection release delay (95th percentile) shall not be greater than 30 seconds in either direction.

4.6.4.1.2.7.1 **Recommendation.**— *The connection release delay (95th percentile) should not be greater than 25 seconds in either direction.*

4.6.4.1.3 INTEGRITY

4.6.4.1.3.1 *Residual error rate, from-aircraft.* The residual error rate in the from-aircraft direction shall not be greater than 10^{-4} per SNSDU.

4.6.4.1.3.1.1 **Recommendation.**— *The residual error rate in the from-aircraft direction should not be greater than 10^{-6} per SNSDU.*

4.6.4.1.3.2 *Residual error rate, to-aircraft.* The residual error rate in the to-aircraft direction shall not be greater than 10^{-6} per SNSDU.

4.6.4.1.3.3 *Connection resilience.* The probability of a subnetwork connection (SNC) provider-invoked SNC release shall not be greater than 10^{-4} over any one-hour interval.

Note.— *Connection releases resulting from GES-to-GES handover, AES log-off or virtual circuit pre-emption are excluded from this specification.*

4.6.4.1.3.4 The probability of an SNC provider-invoked reset shall not be greater than 10^{-1} over any one-hour interval.

4.6.5 Voice service performance

4.6.5.1 If the system provides AMS(R)S voice service, it shall meet the requirements of the following subparagraphs.

Note.— ICAO is currently considering these provisions in the light of the introduction of new technologies.

4.6.5.1.1 CALL PROCESSING DELAY

4.6.5.1.1.1 *AES origination.* The 95th percentile of the time delay for a GES to present a call origination event to the terrestrial network interworking interface after a call origination event has arrived at the AES interface shall not be greater than 20 seconds.

4.6.5.1.1.2 *GES origination.* The 95th percentile of the time delay for an AES to present a call origination event at its aircraft interface after a call origination event has arrived at the terrestrial network interworking interface shall not be greater than 20 seconds.

4.6.5.1.2 VOICE QUALITY

4.6.5.1.2.1 The voice transmission shall provide overall intelligibility performance suitable for the intended operational and ambient noise environment.

4.6.5.1.2.2 The total allowable transfer delay within an AMS(R)S subnetwork shall not be greater than 0.485 seconds.

4.6.5.1.2.3 **Recommendation.**— *Due account should be taken of the effects of tandem vocoders and/or other analog/digital conversions.*

4.6.5.1.3 VOICE CAPACITY

4.6.5.1.3.1 The system shall have sufficient available voice traffic channel resources such that an AES- or GES-originated AMS(R)S voice call presented to the system shall experience a probability of blockage of no more than 10^{-2} .

Note.— *Available voice traffic channel resources include all pre-emptable resources, including those in use by non-AMS(R)S communications.*

4.6.6 Security

4.6.6.1 The system shall provide features for the protection of messages in transit from tampering.

4.6.6.2 The system shall provide features for protection against denial of service, degraded performance characteristics, or reduction of system capacity when subjected to external attacks.

Note.— *Possible methods of such attack include intentional flooding with spurious messages, intentional corruption of system software or databases, or physical destruction of the support infrastructure.*

4.6.6.3 The system shall provide features for protection against unauthorized entry.

Note.— *These features are intended to provide protection against spoofing and “phantom controllers”.*

4.7 SYSTEM INTERFACES

4.7.1 An AMS(R)S system shall allow subnetwork users to address AMS(R)S communications to specific aircraft by means of the ICAO 24-bit aircraft address.

Note.— Provisions on the allocation and assignment of ICAO 24-bit addresses are contained in the Appendix to Chapter 9.

4.7.2 Packet data service interfaces

4.7.2.1 If the system provides AMS(R)S packet data service, it shall provide an interface to the ATN.

Note.— The detailed technical specifications related to provisions of the ATN-compliant subnetwork service are contained in Section 5.2.5 and Section 5.7.2 of Doc 9880 — Manual on Detailed Technical Specifications for the Aeronautical Telecommunication Network (ATN) (in preparation).

4.7.2.2 If the system provides AMS(R)S packet data service, it shall provide a connectivity notification (CN) function.

CHAPTER 5. SSR MODE S AIR-GROUND DATA LINK

Note.— The SSR Mode S air-ground data link is also referred to as the Mode S subnetwork in the context of the aeronautical telecommunication network (ATN).

5.1 DEFINITIONS RELATING TO THE MODE S SUBNETWORK

Aircraft. The term aircraft may be used to refer to Mode S emitters (e.g. aircraft/vehicles), where appropriate.

Aircraft address. A unique combination of 24 bits available for assignment to an aircraft for the purpose of air-ground communications, navigation and surveillance.

Aircraft data circuit-terminating equipment (ADCE). An aircraft specific data circuit-terminating equipment that is associated with an airborne data link processor (ADLP). It operates a protocol unique to Mode S data link for data transfer between air and ground.

Aircraft data link processor (ADLP). An aircraft-resident processor that is specific to a particular air-ground data link (e.g. Mode S) and which provides channel management, and segments and/or reassembles messages for transfer. It is connected to one side of aircraft elements common to all data link systems and on the other side to the air-ground link itself.

Aircraft/vehicle. May be used to describe either a machine or device capable of atmospheric flight, or a vehicle on the airport surface movement area (i.e. runways and taxiways).

Air-initiated protocol. A procedure initiated by a Mode S aircraft installation for delivering a standard length or extended length downlink message to the ground.

BDS Comm-B Data Selector. The 8-bit BDS code determines the register whose contents are to be transferred in the MB field of a Comm-B reply. It is expressed in two groups of 4 bits each, BDS1 (most significant 4 bits) and BDS2 (least significant 4 bits).

Broadcast. The protocol within the Mode S system that permits uplink messages to be sent to all aircraft in coverage area, and downlink messages to be made available to all interrogators that have the aircraft wishing to send the message under surveillance.

Capability report. Information identifying whether the transponder has a data link capability as reported in the capability (CA) field of an all-call reply or squitter transmission (see “data link capability report”).

Close-out. A command from a Mode S interrogator that terminates a Mode S link layer communication transaction.

Cluster of interrogators. Two or more interrogators with the same interrogator identifier (II) code, operating cooperatively to ensure that there is no interference to the required surveillance and data link performance of each of the interrogators, in areas of common coverage.

Comm-A. A 112-bit interrogation containing the 56-bit MA message field. This field is used by the uplink standard length message (SLM) and broadcast protocols.

Comm-B. A 112-bit reply containing the 56-bit MB message field. This field is used by the downlink SLM, ground-initiated and broadcast protocols.

Comm-C. A 112-bit interrogation containing the 80-bit MC message field. This field is used by the uplink extended length message (ELM) protocol.

Comm-D. A 112-bit reply containing the 80-bit MD message field. This field is used by the downlink ELM protocol.

Connection. A logical association between peer-level entities in a communication system.

Data link capability report. Information in a Comm-B reply identifying the complete Mode S communications capabilities of the aircraft installation.

Downlink. A term referring to the transmission of data from an aircraft to the ground. Mode S air-to-ground signals are transmitted on the 1 090 MHz reply frequency channel.

Extended length message (ELM). A series of Comm-C interrogations (uplink ELM) transmitted without the requirement for intervening replies, or a series of Comm-D replies (downlink ELM) transmitted without intervening interrogations.

Uplink ELM (UELM). A term referring to extended length uplink communication by means of 112-bit Mode S Comm-C interrogations, each containing the 80-bit Comm-C message field (MC).

Downlink ELM (DELM). A term referring to extended length downlink communication by means of 112-bit Mode S Comm-D replies, each containing the 80-bit Comm-D message field (MD).

Frame. The basic unit of transfer at the link level. In the context of Mode S subnetwork, a frame can include from one to four Comm-A or Comm-B segments, from two to sixteen Comm-C segments, or from one to sixteen Comm-D segments.

General formatter/manager (GFM). The aircraft function responsible for formatting messages to be inserted in the transponder registers. It is also responsible for detecting and handling error conditions such as the loss of input data.

Ground data circuit-terminating equipment (GDCE). A ground specific data circuit-terminating equipment associated with a ground data link processor (GDLP). It operates a protocol unique to Mode S data link for data transfer between air and ground.

Ground data link processor (GDLP). A ground-resident processor that is specific to a particular air-ground data link (e.g. Mode S), and which provides channel management, and segments and/or reassembles messages for transfer. It is connected on one side (by means of its DCE) to ground elements common to all data link systems, and on the other side to the air-ground link itself.

Ground-initiated Comm-B (GICB). The ground-initiated Comm-B protocol allows the interrogator to extract Comm-B replies containing data from a defined source in the MB field.

Ground-initiated protocol. A procedure initiated by a Mode S interrogator for delivering standard length or extended length messages to a Mode S aircraft installation.

Mode S air-initiated Comm-B (AICB) protocol. A procedure initiated by a Mode S transponder for transmitting a single Comm-B segment from the aircraft installation.

Mode S broadcast protocols. Procedures allowing standard length uplink or downlink messages to be received by more than one transponder or ground interrogator respectively.

Mode S ground-initiated Comm-B (GICB) protocol. A procedure initiated by a Mode S interrogator for eliciting a single Comm-B segment from a Mode S aircraft installation, incorporating the contents of one of 255 Comm-B registers within the Mode S transponder.

Mode S multisite-directed protocol. A procedure to ensure that extraction and close-out of a downlink standard length or extended length message is affected only by the particular Mode S interrogator selected by the aircraft.

Mode S packet. A packet conforming to the Mode S subnetwork standard, designed to minimize the bandwidth required from the air-ground link. ISO 8208 packets may be transformed into Mode S packets and vice-versa.

Mode S specific protocol (MSP). A protocol that provides restricted datagram service within the Mode S subnetwork.

Mode S specific services. A set of communication services provided by the Mode S system which are not available from other air-ground subnetworks, and therefore not interoperable.

Mode S specific services entity (SSE). An entity resident within an XDLP to provide access to the Mode S specific services.

Packet. The basic unit of data transfer among communication devices within the network layer (e.g. an ISO 8208 packet or a Mode S packet).

Segment. A portion of a message that can be accommodated within a single MA/MB field in the case of a standard length message, or MC/MD field in the case of an extended length message. This term is also applied to the Mode S transmissions containing these fields.

Standard length message (SLM). An exchange of digital data using selectively addressed Comm-A interrogations and/or Comm-B replies (see “Comm-A” and “Comm-B”).

Subnetwork. An actual implementation of a data network that employs a homogeneous protocol and addressing plan, and is under the control of a single authority.

Subnetwork management entity (SNME). An entity resident within a GDLP that performs subnetwork management and communicates with peer entities in intermediate or end-systems.

Timeout. The cancellation of a transaction after one of the participating entities has failed to provide a required response within a pre-defined period of time.

Uplink. A term referring to the transmission of data from the ground to an aircraft. Mode S ground-to-air signals are transmitted on the 1 030 MHz interrogation frequency channel.

XDCE. A general term referring to both the ADCE and the GDCE.

XDLP. A general term referring to both the ADLP and the GDLP.

5.2 MODE S CHARACTERISTICS

5.2.1 General provisions

Note 1.— Reference ISO document. When the term “ISO 8208” is referred to in this standard, it means the ISO Standard “Information technology — Data communications — X.25 Packet Layer Protocol for Data Terminal Equipment, Reference Number ISO/IEC 8208: 1990(E)”.

Note 2.— The overall architecture of the Mode S subnetwork is presented in the diagram on the following page.

Note 3.— The processing splits into three different paths. The first consists of the processing of switched virtual circuits (SVCs), the second consists of the processing of Mode S specific services, and the third consists of the processing of subnetwork management information. SVCs utilize the reformatting process and the ADCE or GDCE function. Mode S specific services utilize the Mode S specific services entity (SSE) function.

5.2.1.1 *Message categories.* The Mode S subnetwork shall only carry aeronautical communications classified under categories of flight safety and flight regularity as specified in Annex 10, Volume II, Chapter 5, 5.1.8.4 and 5.1.8.6.

5.2.1.2 *Signals in space.* The signal-in-space characteristics of the Mode S subnetwork shall conform to the provisions contained in Annex 10, Volume IV, Chapter 3, 3.1.2.

5.2.1.3 *Code and byte independency.* The Mode S subnetwork shall be capable of code and byte independent transmission of digital data.

5.2.1.4 *Data transfer.* Data shall be conveyed over the Mode S data link in segments using either standard length message (SLM) protocols or extended length message (ELM) protocols as defined in 3.1.2.6.11 and 3.1.2.7 of Annex 10, Volume IV.

Note 1.— An SLM segment is the contents of one 56-bit MA or MB field. An ELM segment is the contents of one 80-bit MC or MD field.

Note 2.— An SLM frame is the contents of up to four linked MA or MB fields. An ELM frame is the contents of 2 to 16 MC or 1 to 16 MD fields.

5.2.1.5 *Bit numbering.* In the description of the data exchange fields, the bits shall be numbered in the order of their transmission, beginning with bit 1. Bit numbers shall continue through the second and higher segments of multi-segment frames. Unless otherwise stated, numerical values encoded by groups (fields) of bits shall be encoded using positive binary notation and the first bit transmitted shall be the most significant bit (MSB) (3.1.2.3.1.3 of Annex 10, Volume IV).

5.2.1.6 *Unassigned bits.* When the length of the data is not sufficient to occupy all bit positions within a message field or subfield, the unassigned bit positions shall be set to 0.

5.2.2 Frames

5.2.2.1 UPLINK FRAMES

5.2.2.1.1 *SLM frame.* An uplink SLM frame shall be composed of up to four selectively addressed Comm-A segments.

Functional elements of the Mode S subnetwork

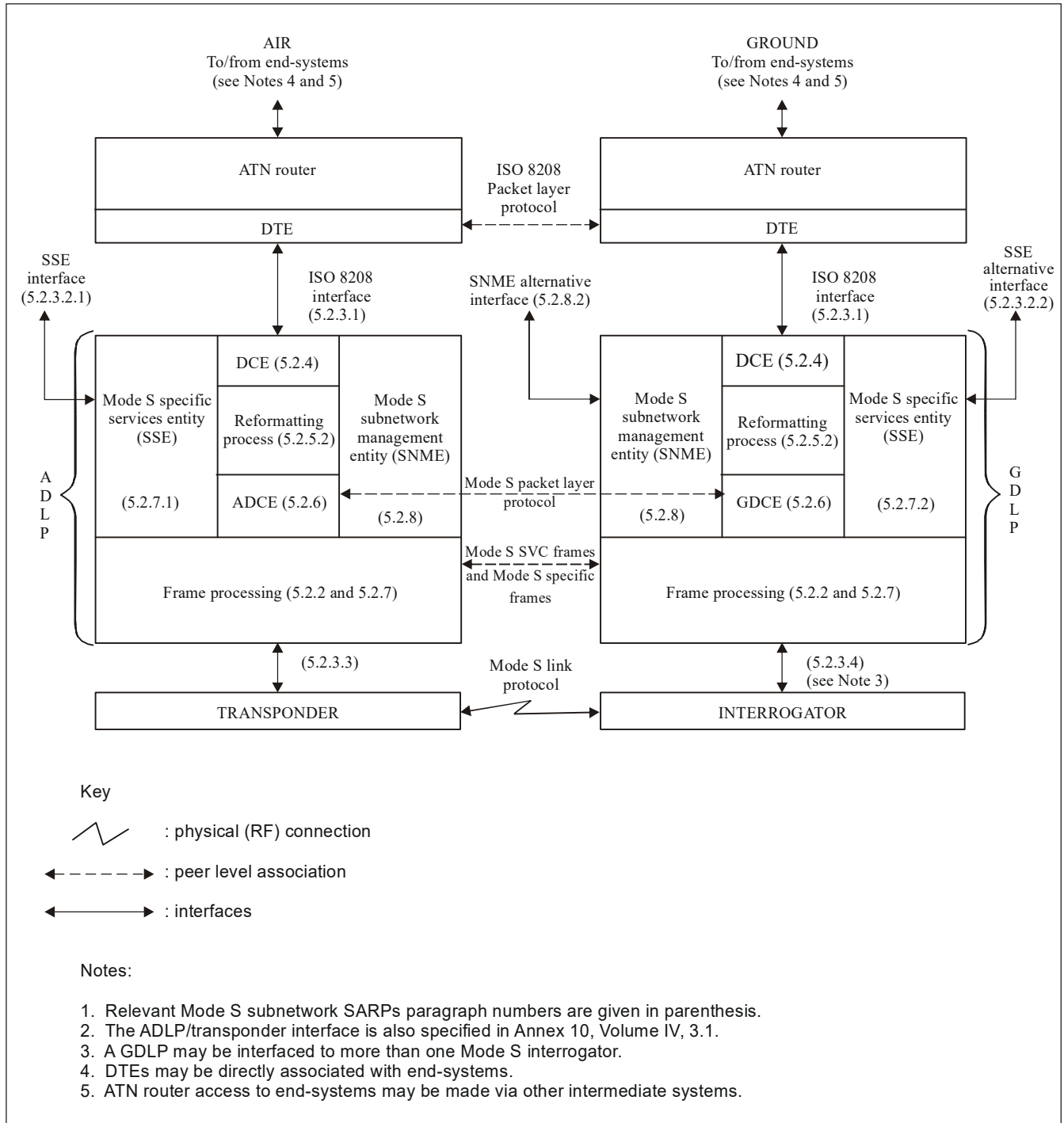

Note.— Each Comm-A segment (MA field) received by the ADLP is accompanied by the first 32 bits of the interrogation that delivered the segment (3.1.2.10.5.2.1.1 of Annex 10, Volume IV). Within these 32 bits is the 16-bit special designator (SD) field (3.1.2.6.1.4 of Annex 10, Volume IV).

5.2.2.1.1.1 *SD field.* When the designator identification (DI) field (bits 14-16) has a code value of 1 or 7, the special designator (SD) field (bits 17-32) of each Comm-A interrogation shall be used to obtain the interrogator identifier subfield (IIS, bits 17-20) and the linked Comm-A subfield (LAS, bits 30-32). The action to be taken shall depend on the value of LAS. The contents of LAS and IIS shall be retained and shall be associated with the Comm-A message segment for use in assembling the frame as indicated below. All fields other than the LAS field shall be as defined in 3.1.2 of Annex 10, Volume IV.

Note.— The SD field structure is shown in Figure 5-1*.

5.2.2.1.1.2 *LAS coding.* The 3-bit LAS subfield shall be coded as follows:

<i>LAS</i>	<i>MEANING</i>
0	single segment
1	linked, 1st segment
2	linked, 2nd but not final segment
3	linked, 3rd but not final segment
4	linked, 4th and final segment
5	linked, 2nd and final segment
6	linked, 3rd and final segment
7	unassigned

5.2.2.1.1.3 *Single segment SLM frame.* If LAS = 0, the data in the MA field shall be considered a complete frame and shall be made available for further processing.

5.2.2.1.1.4 *Multiple segment SLM frame.* The ADLP shall accept and assemble linked 56-bit Comm-A segments associated with all sixteen possible interrogator identifier (II) codes. Correct linking of Comm-A segments shall be achieved by requiring that all Comm-A segments have the same value of IIS. If LAS = 1 through 6, the frame shall consist of two to four Comm-A segments as specified in the following paragraphs.

5.2.2.1.1.4.1 *Initial segment.* If LAS = 1, the MA field shall be assembled as the initial segment of an SLM frame. The initial segment shall be stored until all segments of the frame have been received or the frame is cancelled.

5.2.2.1.1.4.2 *Intermediate segment.* If LAS = 2 or 3, the MA field shall be assembled in numerical order as an intermediate segment of the SLM frame. It shall be associated with previous segments containing the same value of IIS.

5.2.2.1.1.4.3 *Final segment.* If LAS = 4, 5 or 6, the MA field shall be assembled as the final segment of the SLM frame. It shall be associated with previous segments containing the same value of IIS.

5.2.2.1.1.4.4 *Frame completion.* The frame shall be considered complete and shall be made available for further processing as soon as all segments of the frame have been received.

5.2.2.1.1.4.5 *Frame cancellation.* An incomplete SLM frame shall be cancelled if one or more of the following conditions apply:

* All figures and tables are located at the end of this chapter.

- a) a new initial segment ($LAS = 1$) is received with the same value of IIS. In this case, the new initial segment shall be retained as the initial segment of a new SLM frame;
- b) the sequence of received LAS codes (after the elimination of duplicates) is not contained in the following list:
 - 1) $LAS = 0$
 - 2) $LAS = 1,5$
 - 3) $LAS = 1,2,6$
 - 4) $LAS = 1,6,2$
 - 5) $LAS = 1,2,3,4$
 - 6) $LAS = 1,3,2,4$
 - 7) $LAS = 1,2,4,3$
 - 8) $LAS = 1,3,4,2$
 - 9) $LAS = 1,4,2,3$
 - 10) $LAS = 1,4,3,2$
- c) T_c seconds have elapsed since the last Comm-A segment with the same value of IIS was received (Table 5-1).

5.2.2.1.1.4.6 *Segment cancellation.* A received segment for an SLM frame shall be discarded if it is an intermediate or final segment and no initial segment has been received with the same value of IIS.

5.2.2.1.1.4.7 *Segment duplication.* If a received segment duplicates a currently received segment number with the same value of IIS, the new segment shall replace the currently received segment.

Note.— The action of the Mode S subnetwork protocols may result in the duplicate delivery of Comm-A segments.

5.2.2.1.2 *ELM frame.* An uplink ELM frame shall consist of from 20 to 160 bytes and shall be transferred from the interrogator to the transponder using the protocol defined in 3.1.2.7 of Annex 10, Volume IV. The first 4 bits of each uplink ELM segment (MC field) shall contain the interrogator identifier (II) code of the Mode S interrogator transmitting the ELM. The ADLP shall check the II code of each segment of a completed uplink ELM. If all of the segments contain the same II code, the II code in each segment shall be deleted and the remaining message bits retained as user data for further processing. If all of the segments do not contain the same II code, the entire uplink ELM shall be discarded.

Note.— An uplink ELM frame consists of two to sixteen associated Comm-C segments, each of which contains the 4-bit II code. Therefore, the capacity for packet transfer is 19 to 152 bytes per uplink ELM frame.

5.2.2.2 DOWNLINK FRAMES

5.2.2.2.1 *SLM frame.* A downlink SLM frame shall be composed of up to 4 Comm-B segments. The MB field of the first Comm-B segment of the frame shall contain a 2-bit linked Comm-B subfield (LBS, bits 1 and 2 of the MB field). This subfield shall be used to control linking of up to four Comm-B segments.

Note.— The LBS uses the first 2-bit positions in the first segment of a multi or single segment downlink SLM frame. Hence, 54 bits are available for Mode S packet data in the first segment of a downlink SLM frame. The remaining segments of the downlink SLM frame, if any, have 56 bits available.

5.2.2.2.1.1 *LBS coding.* Linking shall be indicated by the coding of the LBS subfield of the MB field of the initial Comm-B segment of the SLM frame.

The coding of LBS shall be as follows:

LBS MEANING

0	single segment
1	initial segment of a two-segment SLM frame
2	initial segment of a three-segment SLM frame
3	initial segment of a four-segment SLM frame

5.2.2.2.1.2 *Linking protocol*

5.2.2.2.1.2.1 In the Comm-B protocol, the initial segment shall be transmitted using the air-initiated or multisite-directed protocols. The LBS field of the initial segment shall indicate to the ground the number of additional segments to be transferred (if any). Before the transmission of the initial segment to the transponder, the remaining segments of the SLM frame (if any) shall be transferred to the transponder for transmission to the interrogator using the ground-initiated Comm-B protocol. These segments shall be accompanied by control codes that cause the segments to be inserted in ground-initiated Comm-B registers 2, 3 or 4, associated respectively with the second, third, or fourth segment of the frame.

5.2.2.2.1.2.2 Close-out of the air-initiated segment that initiated the protocol shall not be performed until all segments have been successfully transferred.

Note.— *The linking procedure including the use of the ground-initiated Comm-B protocol is performed by the ADLP.*

5.2.2.2.1.3 *Directing SLM frames.* If the SLM frame is to be multisite-directed, the ADLP shall determine the II code of the Mode S interrogator or cluster of interrogators (5.2.8.1.3) that shall receive the SLM frame.

5.2.2.2.2 *ELM FRAME*

Note.— *A downlink ELM consists of one to sixteen associated Comm-D segments.*

5.2.2.2.2.1 *Procedure.* Downlink ELM frames shall be used to deliver messages greater than or equal to 28 bytes and shall be formed using the protocol defined in 3.1.2.7 of Annex 10, Volume IV.

5.2.2.2.2.2 *Directing ELM frames.* If the ELM frame is to be multisite-directed, the ADLP shall determine the II code of the Mode S interrogator or cluster of interrogators (5.2.8.1.3) that shall receive the ELM frame.

5.2.2.3 *XDLP frame processing.* Frame processing shall be performed on all Mode S packets (except for the MSP packet) as specified in 5.2.2.3 to 5.2.2.5. Frame processing for Mode S specific services shall be performed as specified in 5.2.7.

5.2.2.3.1 *Packet length.* All packets (including a group of packets multiplexed into a single frame) shall be transferred in a frame consisting of the smallest number of segments needed to accommodate the packet. The user data field shall be an integral multiple of bytes in length. A 4-bit parameter (LV) shall be provided in the Mode S DATA, CALL REQUEST, CALL ACCEPT, CLEAR REQUEST and INTERRUPT packet headers so that during unpacking no additional bytes are added to the user data field. The LV field shall define the number of full bytes used in the last segment of a frame. During LV calculations, the 4-bit II code in the last segment of an uplink ELM message shall be (1) ignored for uplink ELM frames with an odd number of Comm-C segments and (2) counted for uplink ELM frames with an even number of Comm-C segments. The value contained in the LV field shall be ignored if the packet is multiplexed.

Note.— *A specific length field is used to define the length of each element of a multiplexed packet. Therefore the LV field value is not used. LV field error handling is described in Tables 5-16 and 5-19.*

5.2.2.3.2 *Multiplexing.* When multiplexing multiple Mode S packets into single SLM on ELM frame, the following procedures shall be used. Multiplexing of the packets within the ADLP shall not be applied to packets associated with SVCs of different priorities.

Note.— Multiplexing is not performed on MSP packets.

5.2.2.3.2.1 Multiplexing optimization

Recommendation.— When multiple packets are awaiting transfer to the same XDLP, they should be multiplexed into a single frame in order to optimize throughput, provided that packets associated with SVCs of different priorities are not multiplexed together.

5.2.2.3.2.2 Structure. The structure of the multiplexed packets shall be as follows:

HEADER:6 or 8	LENGTH:8	1ST PACKET:v	LENGTH:8	2ND PACKET:v
---------------	----------	--------------	----------	--------------

Note.— A number in the field signifies the field length in bits; “v” signifies that the field is of variable length.

5.2.2.3.2.2.1 Multiplexing header. The header for the multiplexed packets shall be as follows:

DP:1	MP:1	SP:2	ST:2	FILL:0 or 2
------	------	------	------	-------------

Where,

Data packet type (DP) = 0

MSP packet type (MP) = 1

Supervisory packet (SP) = 3

Supervisory type (ST) = 2

Note.— See Figure 5-23 for a definition for the field structure used in the multiplexing header.

5.2.2.3.2.2.2 Length. This field shall contain the length of the following packet in bytes. Any error detected in a multiplexed DATA packet, such as inconsistency between length as indicated in the LENGTH field and the length of the frame hosting that packet, shall result in the discarding of the packet unless the error can be determined to be limited to the LENGTH field, in which case a REJECT packet with the expected PS value can be sent.

5.2.2.3.2.2.1 **Recommendation.**— For multiplex packets, if the entire packet cannot be de-multiplexed, then the first constituent packet should be treated as a format error, and the remainder should be discarded.

5.2.2.3.2.3 Termination. The end of a frame containing a sequence of multiplexed packets shall be determined by one of the following events:

- a) a length field of all zeros; or
- b) less than eight bits left in the frame.

5.2.2.3.3 MODE S CHANNEL SEQUENCE PRESERVATION

5.2.2.3.3.1 Application. In the event that multiple Mode S frames from the same SVC are awaiting transfer to the same XDLP, the following procedure shall be used.

5.2.2.3.3.2 Procedure

Note 1.— SLM and ELM transactions can occur independently.

Note 2.— Uplink and downlink transactions can occur independently.

5.2.2.3.3.2.1 SLM frames. SLM frames awaiting transfer shall be transmitted in the order received.

5.2.2.3.3.2.2 ELM frames. ELM frames awaiting transfer shall be transmitted in the order received.

5.2.2.4 GDLP FRAME PROCESSING

5.2.2.4.1 GENERAL PROVISIONS

5.2.2.4.1.1 The GDLP shall determine the data link capability of the ADLP/transponder installation from the data link capability report (5.2.9) before performing any data link activity with that ADLP.

5.2.2.4.1.2 GDLP frame processing shall provide to the interrogator all data for the uplink transmission that are not provided directly by the interrogator.

5.2.2.4.2 *Delivery status.* GDLP frame processing shall accept an indication from the interrogator function that a specified uplink frame that was previously transferred to the interrogator has been successfully delivered over the ground-to-air link.

5.2.2.4.3 *Aircraft address.* GDLP frame processing shall receive from the interrogator along with the data in each downlink SLM or ELM frame, the 24-bit address of the aircraft that transmitted the frame. GDLP frame processing shall be capable of transferring to the interrogator the 24-bit address of the aircraft that is to receive an uplink SLM or ELM frame.

5.2.2.4.4 *Mode S protocol type identification.* GDLP frame processing shall indicate to the interrogator the protocol to be used to transfer the frame: standard length message protocol, extended length message protocol or broadcast protocol.

5.2.2.4.5 *Frame determination.* A Mode S packet (including multiplexed packets but excluding MSP packets) intended for uplink and less than or equal to 28 bytes shall be sent as an SLM frame. A Mode S packet greater than 28 bytes shall be sent as an uplink ELM frame for transponders with ELM capability, using M-bit processing as necessary (5.2.5.1.4.1). If the transponder does not have ELM capability, packets greater than 28 bytes shall be sent using the M-bit or S-bit (5.2.5.1.4.2) assembly procedures as necessary and multiple SLM frames.

Note.— *The Mode S DATA, CALL REQUEST, CALL ACCEPT, CLEAR REQUEST and INTERRUPT packets are the only Mode S packets that use M-bit or S-bit sequencing.*

5.2.2.5 ADLP FRAME PROCESSING

5.2.2.5.1 *General provisions.* With the possible exception of the last 24 bits (address/parity), ADLP frame processing shall accept from the transponder the entire content of both 56-bit and 112-bit received uplink transmissions, excluding all-call and ACAS interrogations. ADLP frame processing shall provide to the transponder all data for the downlink transmission that is not provided directly by the transponder (5.2.3.3).

5.2.2.5.2 *Delivery status.* ADLP frame processing shall accept an indication from the transponder that a specified downlink frame that was previously transferred to the transponder has been closed out.

5.2.2.5.3 *Interrogator identifier.* ADLP frame processing shall accept from the transponder, along with the data in each uplink SLM and ELM, the interrogator identifier (II) code of the interrogator that transmitted the frame. ADLP frame processing shall transfer to the transponder the II code of the interrogator or cluster of interrogators that shall receive a multisite-directed frame.

5.2.2.5.4 *Mode S protocol type identification.* ADLP frame processing shall indicate to the transponder the protocol to be used to transfer the frame: ground-initiated, air-initiated, broadcast, multisite-directed, standard length or extended length.

5.2.2.5.5 *Frame cancellation.* ADLP frame processing shall be capable of cancelling downlink frames previously transferred to the transponder for transmission but for which a close-out has not been indicated. If more than one frame is stored within the transponder, the cancellation procedure shall be capable of cancelling the stored frames selectively.

5.2.2.5.6 *Frame determination.* A Mode S packet (including multiplexed packets but excluding MSP packets) intended for downlink and less than or equal to 222 bits shall be sent as an SLM frame. A Mode S packet greater than 222 bits shall be sent as a downlink ELM frame for transponders with ELM capability using M-bit processing as necessary (5.2.5.1.4.1). When M-bit processing is used, all ELM frames containing $M = 1$ shall contain the maximum number of ELM segments that the transponder is capable of transmitting in response to one requesting interrogation ($UF = 24$) (5.2.9.1). If the transponder does not have ELM capability, packets greater than 222 bits shall be sent using the M-bit or S-bit (5.2.5.1.4.2) assembly procedures and multiple SLM frames.

Note.— The maximum length of a downlink SLM frame is 222 bits. This is equal to 28 bytes (7 bytes for 4 Comm-B segments) minus the 2-bit linked Comm-B subfield (5.2.2.2.1.1).

5.2.2.6 PRIORITY MANAGEMENT

5.2.2.6.1 *ADLP priority management.* Frames shall be transferred from the ADLP to the transponder in the following order of priority (highest first):

- a) Mode S specific services;
- b) search requests (5.2.8.1);
- c) frames containing only high priority SVC packets; and
- d) frames containing only low priority SVC packets.

5.2.2.6.2 *GDL PRIORITY MANAGEMENT*

Recommendation.— *Uplink frames should be transferred in the following order of priority (highest first):*

- a) *Mode S specific services;*
- b) *frames containing at least one Mode S ROUTE packet (5.2.8.1);*
- c) *frames containing at least one high priority SVC packet; and*
- d) *frames containing only low priority SVC packets.*

5.2.3 Data exchange interfaces

5.2.3.1 THE DTE ISO 8208 INTERFACE

5.2.3.1.1 *General provisions.* The interface between the XDLP and the DTE(s) shall conform to ISO 8208 packet layer protocol (PLP). The XDLP shall support the procedures of the DTE as specified in ISO 8208. As such, the XDLP shall contain a DCE (5.2.4).

5.2.3.1.2 *Physical and link layer requirements for the DTE/DCE interface.* The requirements are:

- a) the interface shall be code and byte independent and shall not impose restrictions on the sequence, order, or pattern of the bits transferred within a packet; and
- b) the interface shall support the transfer of variable length network layer packets.

5.2.3.1.3 DTE ADDRESS

5.2.3.1.3.1 *Ground DTE address.* The ground DTE address shall have a total length of 3 binary coded decimal (BCD) digits, as follows:

$$X_0X_1X_2$$

X_0 shall be the most significant digit. Ground DTE addresses shall be decimal numbers in the range of 0 through 255 coded in BCD. Assignment of the DTE address shall be a local issue. All DTEs connected to GDLPs having overlapping coverage shall have unique addresses. GDLPs which have a flying time less than T_r (Table 5-1) between their coverage areas shall be regarded as having overlapping coverage.

5.2.3.1.3.2 *Mobile DTE address.* The mobile DTE address shall have a total length of 10 BCD digits, as follows:

$$X_0X_1X_2X_3X_4X_5X_6X_7X_8X_9$$

X_0 shall be the most significant digit. The digits X_0 to X_7 shall contain the octal representation of the aircraft address coded in BCD. The digits X_8X_9 shall identify a sub-address for specific DTEs on board an aircraft. This sub-address shall be a decimal number in the range of 0 and 15 coded in BCD. The following sub-address assignments shall be used:

00 ATN router

01 to 15 Unassigned

5.2.3.1.3.3 *Illegal DTE addresses.* DTE addresses outside of the defined ranges or not conforming to the formats for the ground and mobile DTE addresses specified in 5.2.3.1.3.1 and 5.2.3.1.3.2 shall be defined to be illegal DTE addresses. The detection of an illegal DTE address in a CALL REQUEST packet shall lead to a rejection of the call as specified in 5.2.5.1.5.

5.2.3.1.4 PACKET LAYER PROTOCOL REQUIREMENTS OF THE DTE/DCE INTERFACE

5.2.3.1.4.1 *Capabilities.* The interface between the DTE and the DCE shall conform to ISO 8208 with the following capabilities:

- a) expedited data delivery, i.e. the use of INTERRUPT packets with a user data field of up to 32 bytes;

- b) priority facility (with two levels, 5.2.5.2.1.1.6);
- c) fast select (5.2.5.2.1.1.13, 5.2.5.2.1.1.16); and
- d) called/calling address extension facility, if required by local conditions (i.e. the XDLP is connected to the DTE via a network protocol that is unable to contain the Mode S address as defined).

Other ISO 8208 facilities and the D-bit and the Q-bit shall not be invoked for transfer over the Mode S packet layer protocol.

5.2.3.1.4.2 *Parameter values.* The timer and counter parameters for the DTE/DCE interface shall conform to the default ISO 8208 values.

5.2.3.2 MODE S SPECIFIC SERVICES INTERFACE

Note.— Mode S specific services consist of the broadcast Comm-A and Comm-B, GICB and MSP.

5.2.3.2.1 ADLP

5.2.3.2.1.1 *General provisions.* The ADLP shall support the accessing of Mode S specific services through the provision of one or more separate ADLP interfaces for this purpose.

5.2.3.2.1.2 *Functional capability.* Message and control coding via this interface shall support all of the capabilities specified in 5.2.7.1.

5.2.3.2.2 GDLP

5.2.3.2.2.1 *General provisions.* The GDLP shall support the accessing of Mode S specific services through the provision of a separate GDLP interface for this purpose and/or by providing access to these services through the DTE/DCE interface.

5.2.3.2.2.2 *Functional capability.* Message and control coding via this interface shall support all of the capabilities specified in 5.2.7.2.

5.2.3.3 ADLP/TRANSPONDER INTERFACE

5.2.3.3.1 TRANSPONDER TO ADLP

5.2.3.3.1.1 The ADLP shall accept an indication of protocol type from the transponder in connection with data transferred from the transponder to the ADLP. This shall include the following types of protocols:

- a) surveillance interrogation;
- b) Comm-A interrogation;
- c) Comm-A broadcast interrogation; and
- d) uplink ELM.

The ADLP shall also accept the II code of the interrogator used to transmit the surveillance, Comm-A or uplink ELM.

Note.— Transponders will not output all-call and ACAS information on this interface.

5.2.3.3.1.2 The ADLP shall accept control information from the transponder indicating the status of downlink transfers. This shall include:

- a) Comm-B close-out;
- b) Comm-B broadcast timeout; and
- c) downlink ELM close-out.

5.2.3.3.1.3 The ADLP shall have access to current information defining the communication capability of the Mode S transponder with which it is operating. This information shall be used to generate the data link capability report (5.2.9).

5.2.3.3.2 *ADLP TO TRANSPONDER*

5.2.3.3.2.1 The ADLP shall provide an indication of protocol type to the transponder in connection with data transferred from the ADLP to the transponder. This shall include the following types of protocols:

- a) ground-initiated Comm-B;
- b) air-initiated Comm-B;
- c) multisite-directed Comm-B;
- d) Comm-B broadcast;
- e) downlink ELM; and
- f) multisite-directed downlink ELM.

The ADLP shall also provide the II code for transfer of a multisite-directed Comm-B or downlink ELM and the Comm-B data selector (BDS) code (3.1.2.6.11.2 of Annex 10, Volume IV) for a ground-initiated Comm-B.

5.2.3.3.2.2 The ADLP shall be able to perform frame cancellation as specified in 5.2.2.5.5.

5.2.3.4 *GDLP/MODE S INTERROGATOR INTERFACE*

5.2.3.4.1 *INTERROGATOR TO GDLP*

5.2.3.4.1.1 The GDLP shall accept an indication of protocol type from the interrogator in connection with data transferred from the interrogator to the GDLP. This shall include the following types of protocols:

- a) ground-initiated Comm-B;
- b) air-initiated Comm-B;
- c) air-initiated Comm-B broadcast; and
- d) downlink ELM.

The GDLP shall also accept the BDS code used to identify the ground-initiated Comm-B segment.

5.2.3.4.1.2 The GDLP shall accept control information from the interrogator indicating the status of uplink transfers and the status of the addressed Mode S aircraft.

5.2.3.4.2 *GDLP to interrogator.* The GDLP shall provide an indication of protocol type to the interrogator in connection with data transferred from the GDLP to the interrogator. This shall include the following types of protocols:

- a) Comm-A interrogation;
- b) Comm-A broadcast interrogation;
- c) uplink ELM; and
- d) ground-initiated Comm-B request.

The GDLP shall also provide the BDS code for the ground-initiated Comm-B protocol.

5.2.4 DCE operation

Note.— The DCE process within the XDLP acts as a peer process to the DTE. The DCE supports the operations of the DTE with the capability specified in 5.2.3.1.4. The following requirements do not specify format definitions and flow control on the DTE/DCE interface. The specifications and definitions in ISO 8208 apply for these cases.

5.2.4.1 *State transitions.* The DCE shall operate as a state machine. Upon entering a state, the DCE shall perform the actions specified in Table 5-2. State transitions and additional action(s) shall be as specified in Table 5-3 through Table 5-12.

Note.— The next state transition (if any) that occurs when the DCE receives a packet from the DTE is specified by Table 5-3 through Table 5-8. These tables are organized according to the hierarchy illustrated in Figure 5-2. The same transitions are defined in Table 5-9 through Table 5-12 when the DCE receives a packet from the XDCE (via the reformatting process).

5.2.4.2 DISPOSITION OF PACKETS

5.2.4.2.1 Upon receipt of a packet from the DTE, the packet shall be forwarded or not forwarded to the XDCE (via the reformatting process) according to the parenthetical instructions contained in Tables 5-3 to 5-8. If no parenthetical instruction is listed or if the parenthetical instruction indicates “do not forward”, the packet shall be discarded.

5.2.4.2.2 Upon receipt of a packet from the XDCE (via the reformatting process), the packet shall be forwarded or not forwarded to the DTE according to the parenthetical instructions contained in Tables 5-9 to 5-12. If no parenthetical instruction is listed or if the parenthetical instruction indicates “do not forward”, the packet shall be discarded.

5.2.5 Mode S packet layer processing

5.2.5.1 GENERAL REQUIREMENTS

5.2.5.1.1 BUFFER REQUIREMENTS

5.2.5.1.1.1 ADLP buffer requirements

5.2.5.1.1.1.1 The following requirements apply to the entire ADLP and shall be interpreted as necessary for each of the main processes (DCE, reformatting, ADCE, frame processing and SSE).

5.2.5.1.1.1.2 The ADLP shall be capable of maintaining sufficient buffer space for fifteen SVCs:

- a) maintain sufficient buffer space to hold fifteen Mode S subnetwork packets of 152 bytes each in the uplink direction per SVC for a transponder with uplink ELM capability or 28 bytes otherwise;
- b) maintain sufficient buffer space to hold fifteen Mode S subnetwork packets of 160 bytes each in the downlink direction per SVC for a transponder with downlink ELM capability or 28 bytes otherwise;
- c) maintain sufficient buffer space for two Mode S subnetwork INTERRUPT packets of 35 bytes each (user data field plus control information), one in each direction, for each SVC;
- d) maintain sufficient resequencing buffer space for storing thirty-one Mode S subnetwork packets of 152 bytes each in the uplink direction per SVC for a transponder with uplink ELM capability or 28 bytes otherwise; and
- e) maintain sufficient buffer space for the temporary storage of at least one Mode S packet of 160 bytes undergoing M-bit or S-bit processing in each direction per SVC.

5.2.5.1.1.1.3 The ADLP shall be capable of maintaining a buffer of 1 600 bytes in each direction to be shared among all MSPs.

5.2.5.1.1.2 GDLP buffer requirements

5.2.5.1.1.2.1 **Recommendation.**— *The GDLP should be capable of maintaining sufficient buffer space for an average of 4 SVCs for each Mode S aircraft in the coverage area of the interrogators connected to it, assuming all aircraft have ELM capability.*

Note.— *Additional buffer space may be required if DTEs associated with end-systems are supported.*

5.2.5.1.2 CHANNEL NUMBER POOLS

5.2.5.1.2.1 The XDLP shall maintain several SVC channel number pools; the DTE/DCE (ISO 8208) interface uses one set. Its organization, structure and use shall be as defined in the ISO 8208 standard. The other channel pools shall be used on the ADCE/GDCE interface.

5.2.5.1.2.2 The GDLP shall manage a pool of temporary channel numbers in the range of 1 to 3, for each ground DTE/ADLP pair. Mode S CALL REQUEST packets generated by the GDLP shall contain the ground DTE address and a temporary channel number allocated from the pool of that ground DTE. The GDLP shall not reuse a temporary channel number allocated to an SVC that is still in the CALL REQUEST state.

Note 1.— *The use of temporary channel numbers allows the GDLP to have up to three call requests in process at the same time for a particular ground DTE and ADLP combination. It also allows the GDLP or ADLP to clear a channel before the permanent channel number is assigned.*

Note 2.— *The ADLP may be in contact with multiple ground DTEs at any one time. All the ground DTEs use temporary channel numbers ranging from 1 to 3.*

5.2.5.1.2.3 The ADLP shall use the ground DTE address to distinguish the temporary channel numbers used by the various ground DTEs. The ADLP shall assign a permanent channel number (in the range of 1 to 15) to all SVCs and shall inform the GDLP of the assigned number by including it in the Mode S CALL REQUEST by ADLP or Mode S CALL ACCEPT by ADLP packets. The temporary channel number shall be included in the Mode S CALL ACCEPT by ADLP together with the permanent channel number in order to define the association of these channel numbers. The ADLP shall continue to associate the temporary channel number with the permanent channel number of an SVC until the SVC is returned to the READY (p1) state, or else, while in the DATA TRANSFER (p4) state, a Mode S CALL REQUEST by GDLP packet

is received bearing the same temporary channel number. A non-zero permanent channel number in the Mode S CLEAR REQUEST by ADLP, CLEAR REQUEST by GDLP, CLEAR CONFIRMATION by ADLP or CLEAR CONFIRMATION by GDLP packet shall indicate that the permanent channel number shall be used and the temporary channel number shall be ignored. In the event that an XDLP is required to send one of these packets in the absence of a permanent channel number, the permanent channel number shall be set to zero, which shall indicate to the peer XDLP that the temporary channel number is to be used.

Note.— *The use of a zero permanent channel number allows the ADLP to clear an SVC when no permanent channel number is available, and allows the GDLP to do likewise before it has been informed of the permanent channel number.*

5.2.5.1.2.4 The channel number used by the DTE/DCE interface and that used by the ADCE/GDCE interface shall be assigned independently. The reformatting process shall maintain an association table between the DTE/DCE and the ADCE/GDCE channel numbers.

5.2.5.1.3 *Receive ready and receive not ready conditions.* The ISO 8208 interface and the ADCE/GDCE interface management procedures shall be independent operations since each system must be able to respond to separate receive ready and receive not ready indications.

5.2.5.1.4 PROCESSING OF M-BIT AND S-BIT SEQUENCES

Note.— *M-bit processing applies to the sequencing of the DATA packet. S-bit processing applies to the sequencing of Mode S CALL REQUEST, CALL ACCEPT, CLEAR REQUEST and INTERRUPT packets.*

5.2.5.1.4.1 M-bit processing

Note.— *The packet size used on the DTE/DCE interface can be different from that used on the ADCE/GDCE interface.*

5.2.5.1.4.1.1 M-bit processing shall be used when DATA packets are reformatted (5.2.5.2). M-bit processing shall utilize the specifications contained in the ISO 8208 standard. The M-bit sequence processing shall apply on a per channel basis. The M-bit set to 1 shall indicate that a user data field continues in the subsequent DATA packet. Subsequent packets in an M-bit sequence shall use the same header format (i.e. the packet format excluding the user data field).

5.2.5.1.4.1.2 If the packet size for the XDCE (5.2.6.4.2) interface is larger than that used on the DTE/DCE interface, packets shall be combined to the extent possible as dictated by the M-bit, when transmitting a Mode S DATA packet. If the packet size is smaller on the XDCE interface than that defined on the DTE/DCE interface, packets shall be fragmented to fit into the smaller Mode S packet using M-bit assembly.

5.2.5.1.4.1.3 A packet shall be combined with subsequent packets if the packet is filled and more packets exist in the M-bit sequence (M-bit = 1). A packet smaller than the maximum packet size defined for this SVC (partial packet) shall only be allowed when the M-bit indicates the end of an M-bit sequence. A received packet smaller than the maximum packet size with M-bit equal to 1 shall cause a reset to be generated as specified in ISO 8208 and the remainder of the sequence should be discarded.

5.2.5.1.4.1.4 **Recommendation.**— *In order to decrease delivery delay, reformatting should be performed on the partial receipt of an M-bit sequence, rather than delay reformatting until the complete M-bit sequence is received.*

5.2.5.1.4.2 *S-bit processing.* S-bit processing shall apply only to Mode S CALL REQUEST, CALL ACCEPT, CLEAR REQUEST and INTERRUPT packets. This processing shall be performed as specified for M-bit processing (5.2.5.1.4.1) except that the packets associated with any S-bit sequence whose reassembly is not completed in T_q seconds (Tables 5-1 and 5-13) shall be discarded (5.2.6.3.6, 5.2.6.4.5.2 and 5.2.6.9), and receipt of a packet shorter than the maximum packet size with S = 1 shall cause the entire S-bit sequence to be treated as a format error in accordance with Table 5-16.

5.2.5.1.5 MODE S SUBNETWORK ERROR PROCESSING FOR ISO 8208 PACKETS

5.2.5.1.5.1 *D-bit*. If the XDLP receives a DATA packet with the D-bit set to 1, the XDLP shall send a RESET REQUEST packet to the originating DTE containing a cause code (CC) = 133 and a diagnostic code (DC) = 166. If the D-bit is set to 1 in a CALL REQUEST packet, the D-bit shall be ignored by the XDLP. The D-bit of the corresponding CALL ACCEPT packet shall always be set to 0. The use of CC is optional.

5.2.5.1.5.2 *Q-bit*. If the XDLP receives a DATA packet with the Q-bit set to 1, the XDLP shall send a RESET REQUEST packet to the originating DTE containing CC = 133 and DC = 83. The use of CC is optional.

5.2.5.1.5.3 *Invalid priority*. If the XDLP receives a call request with a connection priority value equal to 2 through 254, the XDLP shall clear the virtual circuit using DC = 66 and CC = 131. The use of CC is optional.

5.2.5.1.5.4 *Unsupported facility*. If the XDLP receives a call request with a request for a facility that it cannot support, the XDLP shall clear the virtual circuit using DC = 65 and C = 131. The use of CC is optional.

5.2.5.1.5.5 *Illegal calling DTE address*. If the XDLP receives a call request with an illegal calling DTE address (5.2.3.1.3.3), the XDLP shall clear the virtual circuit using DC = 68 and CC = 141. The use of CC is optional.

5.2.5.1.5.6 *Illegal called DTE address*. If the XDLP receives a call request with an illegal called DTE address (5.2.3.1.3.3), the XDLP shall clear the virtual circuit using DC = 67 and CC = 141. The use of CC is optional.

5.2.5.2 REFORMATTING PROCESS

Note.— The reformatting process is divided into two subprocesses: uplink formatting and downlink formatting. For the ADLP, the uplink process reformats Mode S packets into ISO 8208 packets and the downlink process reformats ISO 8208 packets into Mode S packets. For the GDLP, the uplink process reformats ISO 8208 packets into Mode S packets and the downlink process reformats Mode S packets into ISO 8208 packets.

5.2.5.2.1 CALL REQUEST BY ADLP

5.2.5.2.1.1 Translation into Mode S packets

5.2.5.2.1.1.1 *Translated packet format*. Reception by the ADLP reformatting process of an ISO 8208 CALL REQUEST packet from the local DCE shall result in the generation of corresponding Mode S CALL REQUEST by ADLP packet(s) (as determined by S-bit processing (5.2.5.1.4.2)) as follows:

DP:1	MP:1	SP:2	ST:2	FILL2:0 or 2	P:1	FILL:1	SN:6	CH:4	AM:4	AG:8	S:1	FS:2	F:1	LV:4	UD:v
------	------	------	------	--------------	-----	--------	------	------	------	------	-----	------	-----	------	------

5.2.5.2.1.1.2 *Data packet type (DP)*. This field shall be set to 0.

5.2.5.2.1.1.3 *MSP packet type (MP)*. This field shall be set to 1.

5.2.5.2.1.1.4 *Supervisory packet (SP)*. This field shall be set to 1.

5.2.5.2.1.1.5 *Supervisory type (ST)*. This field shall be set to 0.

5.2.5.2.1.1.6 *Priority (P)*. This field shall be set to 0 for a low priority SVC and to 1 for a high priority SVC. The value for this field shall be obtained from the data transfer field of the priority facility of the ISO 8208 packet, and shall be set to 0

if the ISO 8208 packet does not contain the priority facility or if a priority of 255 is specified. The other fields of the priority facility shall be ignored.

5.2.5.2.1.1.7 *Sequence number (SN)*. For a particular SVC, each packet shall be numbered (5.2.6.9.4).

5.2.5.2.1.1.8 *Channel number (CH)*. The channel number shall be chosen from the pool of SVC channel numbers available to the ADLP. The pool shall consist of 15 values from 1 through 15. The highest available channel number shall be chosen from the pool. An available channel shall be defined as one in state *p1*. The correspondence between the channel number used by the Mode S subnetwork and the number used by the DTE/DCE interface shall be maintained while the channel is active.

Note.— Also refer to 5.2.5.1.2 on channel pool management.

5.2.5.2.1.1.9 *Address, mobile (AM)*. This address shall be the mobile DTE sub-address (5.2.3.1.3.2) in the range of 0 to 15. The address shall be extracted from the two least significant digits of the calling DTE address contained in the ISO 8208 packet and converted to binary representation.

Note.— The 24-bit aircraft address is transferred within the Mode S link layer.

5.2.5.2.1.1.10 *Address, ground (AG)*. This address shall be the ground DTE address (5.2.3.1.3.1) in the range of 0 to 255. The address shall be extracted from the called DTE address contained in the ISO 8208 packet and converted to binary representation.

5.2.5.2.1.1.11 *Fill field*. The fill field shall be used to align subsequent data fields on byte boundaries. When indicated as “FILL:n”, the fill field shall be set to a length of “n” bits. When indicated as “FILL1: 0 or 6”, the fill field shall be set to a length of 6 bits for a non-multiplexed packet in a downlink SLM frame and 0 bit for all other cases. When indicated as “FILL2: 0 or 2”, the fill field shall be set to a length of 0 bit for a non-multiplexed packet in a downlink SLM frame or for a multiplexing header and 2 bits for all other cases.

5.2.5.2.1.1.12 *S field (S)*. A value of 1 shall indicate that the packet is part of an S-bit sequence with more packets in the sequence to follow. A value of 0 shall indicate that the sequence ends with this packet. This field shall be set as specified in 5.2.5.1.4.2.

5.2.5.2.1.1.13 *FS field (FS)*. A value of 0 shall indicate that the packet does not contain fast select data. A value of 2 or 3 shall indicate that the packet contains fast select data. A value of 2 shall indicate normal fast select operation. A value of 3 shall indicate fast select with restricted response. An FS value of 1 shall be undefined.

5.2.5.2.1.1.14 *First packet flag (F)*. This field shall be set to 0 in the first packet of an S-bit sequence and in a packet that is not part of an S-bit sequence. Otherwise it shall be set to 1.

5.2.5.2.1.1.15 *User data length (LV)*. This field shall indicate the number of full bytes used in the last SLM or ELM segment as defined in 5.2.2.3.1.

5.2.5.2.1.1.16 *User data field (UD)*. This field shall only be present if optional CALL REQUEST user data (maximum 16 bytes) or fast select user data (maximum 128 bytes) is contained in the ISO 8208 packet. The user data field shall be transferred from ISO 8208 packet unchanged using S-bit processing as specified in 5.2.5.1.4.2.

5.2.5.2.1.2 *Translation into ISO 8208 packets*

5.2.5.2.1.2.1 *Translation*. Reception by the GDLP reformatting process of a Mode S CALL REQUEST by ADLP packet (or an S-bit sequence of packets) from the GDCE shall result in the generation of a corresponding ISO 8208 CALL REQUEST packet to the local DCE. The translation from the Mode S packet to the ISO 8208 packet shall be the inverse of the processing defined in 5.2.5.2.1.1 with the exceptions as specified in 5.2.5.2.1.2.2.

5.2.5.2.1.2.2 *Called DTE, calling DTE address and length fields.* The calling DTE address shall be composed of the aircraft address and the value contained in the AM field of the Mode S packet, converted to BCD (5.2.3.1.3.2). The called DTE address shall be the ground DTE address contained in the AG field of the Mode S packet, converted to BCD. The length field shall be as defined in ISO 8208.

5.2.5.2.2 CALL REQUEST BY GDLP

5.2.5.2.2.1 Translation into Mode S packets

5.2.5.2.2.1.1 *General.* Reception by the GDLP reformatting process of an ISO 8208 CALL REQUEST packet from the local DCE shall result in the generation of corresponding Mode S CALL REQUEST by GDLP packet(s) (as determined by S-bit processing (5.2.5.1.4.2)) as follows:

DP:1	MP:1	SP:2	ST:2	FILL:2	P:1	FILL:1	SN:6	FILL:2	TC:2	AM:4	AG:8	S:1	FS:2	F:1	LV:4	UD:v
------	------	------	------	--------	-----	--------	------	--------	------	------	------	-----	------	-----	------	------

Fields shown in the packet format and not specified in the following paragraphs shall be set as specified in 5.2.5.2.1.

5.2.5.2.2.1.2 *Data packet type (DP).* This field shall be set to 0.

5.2.5.2.2.1.3 *MSP packet type (MP).* This field shall be set to 1.

5.2.5.2.2.1.4 *Supervisory packet (SP).* This field shall be set to 1.

5.2.5.2.2.1.5 *Supervisory type (ST).* This field shall be set to 0.

5.2.5.2.2.1.6 *Temporary channel number field (TC).* This field shall be used to distinguish multiple call requests from a GDLP. The ADLP reformatting process, upon receipt of a temporary channel number, shall assign a channel number from those presently in the READY state, *p1*.

5.2.5.2.2.1.7 *Address, ground (AG).* This address shall be the ground DTE address (5.2.3.1.3.1) in the range of 0 to 255. The address shall be extracted from the calling DTE address contained in the ISO 8208 packet and converted to binary representation.

5.2.5.2.2.1.8 *Address, mobile (AM).* This address shall be the mobile DTE sub-address (5.2.3.1.3.2) in the range of 0 to 15. The address shall be extracted from the two least significant digits of the called DTE address contained in the ISO 8208 packet and converted to binary representation.

5.2.5.2.2.2 Translation into ISO 8208 packets

5.2.5.2.2.2.1 *Translation.* Reception by the ADLP reformatting process of a Mode S CALL REQUEST by GDLP packet (or an S-bit sequence of packets) from the ADCE shall result in the generation of a corresponding ISO 8208 CALL REQUEST packet to the local DCE. The translation from the Mode S packet to the ISO 8208 packet shall be the inverse of the processing defined in 5.2.5.2.2.1 with the exceptions as specified in 5.2.5.2.2.2.2.

5.2.5.2.2.2.2 *Called DTE, calling DTE address and length fields.* The called DTE address shall be composed of the aircraft address and the value contained in the AM field of the Mode S packet, converted to BCD (5.2.3.1.3.2). The calling DTE address shall be the ground DTE address contained in the AG field of the Mode S packet, converted to BCD. The length field shall be as defined in ISO 8208.

5.2.5.2.3 CALL ACCEPT BY ADLP

5.2.5.2.3.1 Translation into Mode S packets

5.2.5.2.3.1.1 *Translated packet format.* Reception by the ADLP reformatting process of an ISO 8208 CALL ACCEPT packet from the local DCE shall result in the generation of corresponding Mode S CALL ACCEPT by ADLP packet(s) (as determined by S-bit processing (5.2.5.1.4.2)) as follows:

DP:1	MP:1	SP:2	ST:2	FILL2:0 or 2	TC:2	SN:6	CH:4	AM:4	AG:8	S:1	FILL:2	F:1	LV:4	UD:v
------	------	------	------	--------------	------	------	------	------	------	-----	--------	-----	------	------

Fields shown in the packet format and not specified in the following paragraphs shall be set as specified in 5.2.5.2.1.

5.2.5.2.3.1.2 *Data packet type (DP).* This field shall be set to 0.

5.2.5.2.3.1.3 *MSP packet type (MP).* This field shall be set to 1.

5.2.5.2.3.1.4 *Supervisory packet (SP).* This field shall be set to 1.

5.2.5.2.3.1.5 *Supervisory type (ST).* This field shall be set to 1.

5.2.5.2.3.1.6 *Temporary channel number (TC).* The TC value in the originating Mode S CALL REQUEST by GDLP packet shall be returned to the GDLP along with the channel number (CH) assigned by the ADLP.

5.2.5.2.3.1.7 *Channel number (CH).* The field shall be set equal to the channel number assigned by the ADLP as determined during the CALL REQUEST procedures for the Mode S connection.

5.2.5.2.3.1.8 *Address, mobile and address, ground.* The AM and AG values in the originating Mode S CALL REQUEST by GDLP packet shall be returned in these fields. When present, DTE addresses in the ISO 8208 CALL ACCEPT packet shall be ignored.

5.2.5.2.3.2 Translation into ISO 8208 packets

5.2.5.2.3.2.1 *Translation.* Reception by the GDLP reformatting process of a Mode S CALL ACCEPT by ADLP packet (or an S-bit sequence of packets) from the GDCE shall result in the generation of a corresponding ISO 8208 CALL ACCEPT packet to the local DCE. The translation from the Mode S packet to the ISO 8208 packet shall be the inverse of the processing defined in 5.2.5.2.3.1 with the exceptions as specified in 5.2.5.2.3.2.2.

5.2.5.2.3.2.2 *Called DTE, calling DTE address and length fields.* Where present, the called DTE address shall be composed of the aircraft address and the value contained in the AM field of the Mode S packet, converted to BCD (5.2.3.1.3.2). Where present, the calling DTE address shall be the ground DTE address contained in the AG field of the Mode S packet, converted to BCD. The length field shall be as defined in ISO 8208.

Note.— The called and calling DTE addresses are optional in the corresponding ISO 8208 packet and are not required for correct operation of the Mode S subnetwork.

5.2.5.2.4 CALL ACCEPT BY GDLP

5.2.5.2.4.1 Translation into Mode S packets

5.2.5.2.4.1.1 *Translated packet format.* Reception by the GDLP reformatting process of an ISO 8208 CALL ACCEPT packet from the local DCE shall result in the generation of corresponding Mode S CALL ACCEPT by GDLP packet(s) (as determined by S-bit processing (5.2.5.1.4.2)) as follows:

DP:1	MP:1	SP:2	ST:2	FILL:2	FILL:2	SN:6	CH:4	AM:4	AG:8	S:1	FILL:2	F:1	LV:4	UD:v
------	------	------	------	--------	--------	------	------	------	------	-----	--------	-----	------	------

Fields shown in the packet format and not specified in the following paragraphs shall be set as specified in 5.2.5.2.1.

5.2.5.2.4.1.2 *Data packet type (DP)*. This field shall be set to 0.

5.2.5.2.4.1.3 *MSP packet type (MP)*. This field shall be set to 1.

5.2.5.2.4.1.4 *Supervisory packet (SP)*. This field shall be set to 1.

5.2.5.2.4.1.5 *Supervisory type (ST)*. This field shall be set to 1.

5.2.5.2.4.1.6 *Address, mobile and address, ground*. The AM and AG values in the originating Mode S CALL REQUEST by ADLP packet shall be returned in these fields. When present, DTE addresses in the ISO 8208 CALL ACCEPT packet shall be ignored.

5.2.5.2.4.2 *Translation into ISO 8208 packets*

5.2.5.2.4.2.1 *Translation*. Reception by the ADLP reformatting process of a Mode S CALL ACCEPT by GDLP packet (or an S-bit sequence of packets) from the ADCE shall result in the generation of a corresponding ISO 8208 CALL ACCEPT packet to the local DCE. The translation from the Mode S packet to the ISO 8208 packet shall be the inverse of the processing defined in 5.2.5.2.4.1 with the exceptions as specified in 5.2.5.2.4.2.2.

5.2.5.2.4.2.2 *Called DTE, calling DTE address and length fields*. Where present, the calling DTE address shall be composed of the aircraft address and the value contained in the AM field of the Mode S packet, converted to BCD (5.2.3.1.3.2). Where present, the called DTE address shall be the ground DTE address contained in the AG field of the Mode S packet, converted to BCD. The length field shall be as defined in ISO 8208.

Note.— The called and calling DTE addresses are optional in the corresponding ISO 8208 packet and are not required for correct operation of the Mode S subnetwork.

5.2.5.2.5 *CLEAR REQUEST BY ADLP*

5.2.5.2.5.1 *Translation into Mode S packets*

5.2.5.2.5.1.1 *Translated packet format*. Reception by the ADLP reformatting process of an ISO 8208 CLEAR REQUEST packet from the local DCE shall result in the generation of a corresponding Mode S CLEAR REQUEST by ADLP packet(s) (as determined by S-bit processing (5.2.5.1.4.2)) as follows:

DP:1	MP:1	SP:2	ST:2	FILL:2:0 or 2	TC:2	SN:6	CH:4	AM:4	AG:8	CC:8	DC:8	S:1	FILL:2	F:1	LV:4	UD:v
------	------	------	------	---------------	------	------	------	------	------	------	------	-----	--------	-----	------	------

Fields shown in the packet format and not specified in the following paragraphs shall be set as specified in 5.2.5.2.1 and 5.2.5.2.2.

5.2.5.2.5.1.2 *Data packet type (DP)*. This field shall be set to 0.

5.2.5.2.5.1.3 *MSP packet type (MP)*. This field shall be set to 1.

5.2.5.2.5.1.4 *Supervisory packet (SP)*. This field shall be set to 1.

5.2.5.2.5.1.5 *Channel number (CH)*: If a channel number has been allocated during the call acceptance phase, then CH shall be set to that value, otherwise it shall be set to zero.

5.2.5.2.5.1.6 *Temporary channel (TC)*: If a channel number has been allocated during the call acceptance phase, then TC shall be set to zero, otherwise it shall be set to the value used in the CALL REQUEST by GDLP.

5.2.5.2.5.1.7 *Supervisory type (ST)*. This field shall be set to 2.

5.2.5.2.5.1.8 *Address, ground or address, mobile*. The AG and AM values in the originating Mode S CALL REQUEST by ADLP or CALL REQUEST by GDLP packets shall be returned in these fields. When present, DTE addresses in the ISO 8208 CLEAR REQUEST packet shall be ignored.

5.2.5.2.5.1.9 *Clearing cause (CC) and diagnostic code (DC) fields*. These fields shall be transferred without modification from the ISO 8208 packet to the Mode S packet when the DTE has initiated the clear procedure. If the XDLP has initiated the clear procedure, the clearing cause field and diagnostic field shall be as defined in the state tables for the DCE and XDCE (see also 5.2.6.3.3). The coding and definition of these fields shall be as specified in ISO 8208.

5.2.5.2.5.2 *Translation into ISO 8208 packets*

5.2.5.2.5.2.1 *Translation*. Reception by the GDLP reformatting process of a Mode S CLEAR REQUEST by ADLP packet (or an S-bit sequence of packets) from the local GDCE shall result in the generation of a corresponding ISO 8208 CLEAR REQUEST packet to the local DCE. The translation from the Mode S packet to the ISO 8208 packet shall be the inverse of the processing defined in 5.2.5.2.5.1 with the exceptions specified in 5.2.5.2.5.2.2 and 5.2.5.2.5.2.3.

5.2.5.2.5.2.2 *Called DTE, calling DTE and length fields*. These fields shall be omitted in the ISO 8208 CLEAR REQUEST packet.

5.2.5.2.5.2.3 *Clearing cause field*. This field shall be set taking account of 5.2.6.3.3.

5.2.5.2.6 *CLEAR REQUEST BY GDLP*

5.2.5.2.6.1 *Translation into Mode S packets*

5.2.5.2.6.1.1 *Translated packet format*. Reception by the GDLP reformatting process of an ISO 8208 CLEAR REQUEST packet from the local DCE shall result in the generation of corresponding Mode S CLEAR REQUEST by GDLP packet(s) (as determined by S-bit processing (5.2.5.1.4.2)) as follows:

DP:1	MP:1	SP:2	ST:2	FILL:2	TC:2	SN:6	CH:4	AM:4	AG:8	CC:8	DC:8	S:1	FILL:2	F:1	LV:4	UD:v
------	------	------	------	--------	------	------	------	------	------	------	------	-----	--------	-----	------	------

Fields shown in the packet format and not specified in the following paragraphs shall be set as specified in 5.2.5.2.1, 5.2.5.2.2 and 5.2.5.2.5.

5.2.5.2.6.1.2 *Data packet type (DP)*. This field shall be set to 0.

5.2.5.2.6.1.3 *MSP packet type (MP)*. This field shall be set to 1.

5.2.5.2.6.1.4 *Supervisory packet (SP)*. This field shall be set to 1.

5.2.5.2.6.1.5 *Channel number (CH)*: If a channel number has been allocated during the call acceptance phase, then CH shall be set to that value, otherwise it shall be set to zero.

5.2.5.2.6.1.6 *Temporary channel (TC)*: If a channel number has been allocated during the call acceptance phase, then TC shall be set to zero, otherwise it shall be set to the value used in the CALL REQUEST by GDLP.

5.2.5.2.6.1.7 *Supervisory type (ST)*. This field shall be set to 2.

5.2.5.2.6.2 *Translation into ISO 8208 packets*

5.2.5.2.6.2.1 *Translation*. Reception by the ADLP reformatting process of a Mode S CLEAR REQUEST by GDLP packet (or an S-bit sequence of packets) from the local ADCE shall result in the generation of a corresponding ISO 8208 CLEAR REQUEST packet to the local DCE. The translation from the Mode S packet to the ISO 8208 packet shall be the inverse of the processing defined in 5.2.5.2.6.1.

5.2.5.2.6.2.2 *Called DTE, calling DTE and length fields*. These fields shall be omitted in the ISO 8208 CLEAR REQUEST packet.

5.2.5.2.7 *DATA*

5.2.5.2.7.1 *Translation into Mode S packets*

5.2.5.2.7.1.1 *Translated packet format*. Reception by the XDLP reformatting process of ISO 8208 DATA packet(s) from the local DCE shall result in the generation of corresponding Mode S DATA packet(s) as determined by M-bit processing (5.2.5.1.4.1), as follows:

DP:1	M:1	SN:6	FILL:1:0 or 6	PS:4	PR:4	CH:4	LV:4	UD:v
------	-----	------	---------------	------	------	------	------	------

5.2.5.2.7.1.2 *Data packet type (DP)*. This field shall be set to 1.

5.2.5.2.7.1.3 *M field (M)*. A value of 1 shall indicate that the packet is part of an M-bit sequence with more packets in the sequence to follow. A value of 0 shall indicate that the sequence ends with this packet. The appropriate value shall be placed in the M-bit field of the Mode S packet.

Note.— See 5.2.5.1.4 and ISO 8208 for a complete explanation.

5.2.5.2.7.1.4 *Sequence number (SN)*. The sequence number field shall be set as specified in 5.2.5.2.1.1.7.

5.2.5.2.7.1.5 *Packet send sequence number (PS)*. The packet send sequence number field shall be set as specified in 5.2.6.4.4.

5.2.5.2.7.1.6 *Packet receive sequence number (PR)*. The packet receive sequence number field shall be set as specified in 5.2.6.4.4.

5.2.5.2.7.1.7 *Channel number (CH)*. The channel number field shall contain the Mode S channel number that corresponds to the incoming ISO 8208 DATA packet channel number.

5.2.5.2.7.1.8 *User data length (LV)*. This field shall indicate the number of full bytes used in the last SLM or ELM segment as defined in 5.2.2.3.1.

5.2.5.2.7.1.9 *Fill (FILL1)*. This field shall be set as specified in 5.2.5.2.1.1.11.

5.2.5.2.7.1.10 *User data (UD)*. The user data shall be transferred from the ISO 8208 packet to the Mode S packet utilizing the M-bit packet assembly processing as required.

5.2.5.2.7.2 *Translation into ISO 8208 packets.* Reception by the XDLP reformatting process of Mode S DATA packet(s) from the local XDCE shall result in the generation of corresponding ISO 8208 DATA packet(s) to the local DCE. The translation from Mode S packet(s) to the ISO 8208 packet(s) shall be the inverse of the processing defined in 5.2.5.2.7.1.

5.2.5.2.8 *INTERRUPT*

5.2.5.2.8.1 *Translation into Mode S packets*

5.2.5.2.8.1.1 *Translated packet format.* Reception by the XDLP reformatting process of an ISO 8208 INTERRUPT packet from the local DCE shall result in the generation of corresponding Mode S INTERRUPT packet(s) (as determined by S-bit processing (5.2.5.1.4.2)) as follows:

DP:1	MP:1	SP:2	ST:2	FILL2:0 or 2	S:1	F:1	SN:6	CH:4	LV:4	UD:v
------	------	------	------	--------------	-----	-----	------	------	------	------

Fields shown in the packet format and not specified in the following paragraphs shall be set as specified in 5.2.5.2.1.

5.2.5.2.8.1.2 *Data packet type (DP).* This field shall be set to 0.

5.2.5.2.8.1.3 *MSP packet type (MP).* This field shall be set to 1.

5.2.5.2.8.1.4 *Supervisory packet (SP).* This field shall be set to 3.

5.2.5.2.8.1.5 *Supervisory type (ST).* This field shall be set to 1.

5.2.5.2.8.1.6 *User data length (LV).* This field shall be set as specified in 5.2.2.3.1.

5.2.5.2.8.1.7 *User data (UD).* The user data shall be transferred from the ISO 8208 packet to the Mode S packet using the S-bit packet reassembly processing as required. The maximum size of the user data field for an INTERRUPT packet shall be 32 bytes.

5.2.5.2.8.2 *Translation into ISO 8208 packets.* Reception by the XDLP reformatting process of Mode S INTERRUPT packet(s) from the local XDCE shall result in the generation of a corresponding ISO 8208 INTERRUPT packet to the local DCE. The translation from the Mode S packet(s) to the ISO 8208 packet shall be the inverse of the processing defined in 5.2.5.2.8.1.

5.2.5.2.9 *INTERRUPT CONFIRMATION*

5.2.5.2.9.1 *Translation into Mode S packets*

5.2.5.2.9.1.1 *Translated packet format.* Reception by the XDLP reformatting process of an ISO 8208 INTERRUPT CONFIRMATION packet from the local DCE shall result in the generation of a corresponding Mode S INTERRUPT CONFIRMATION packet as follows:

DP:1	MP:1	SP:2	ST:2	SS:2	FILL2:0 or 2	SN:6	CH:4	FILL:4
------	------	------	------	------	--------------	------	------	--------

Fields shown in the packet format and not specified in the following paragraphs shall be set as specified in 5.2.5.2.1.

5.2.5.2.9.1.2 *Data packet type (DP).* This field shall be set to 0.

5.2.5.2.9.1.3 *MSP packet type (MP).* This field shall be set to 1.

5.2.5.2.9.1.4 *Supervisory packet (SP)*. This field shall be set to 3.

5.2.5.2.9.1.5 *Supervisory type (ST)*. This field shall be set to 3.

5.2.5.2.9.1.6 *Supervisory subset (SS)*. This field shall be set to 0.

5.2.5.2.9.2 *Translation into ISO 8208 packets*. Reception by the XDLP reformatting process of a Mode S INTERRUPT CONFIRMATION packet from the local XDCE shall result in the generation of a corresponding ISO 8208 INTERRUPT CONFIRMATION packet to the local DCE. The translation from the Mode S packet to the ISO 8208 packet shall be the inverse of the processing defined in 5.2.5.2.9.1.

5.2.5.2.10 *RESET REQUEST*

5.2.5.2.10.1 *Translation into Mode S packets*

5.2.5.2.10.1.1 *Translated packet format*. Reception by the XDLP reformatting process of an ISO 8208 RESET REQUEST packet from the local DCE shall result in the generation of a corresponding Mode S RESET REQUEST packet as follows:

DP:1	MP:1	SP:2	ST:2	FILL2:0 or 2	FILL:2	SN:6	CH:4	FILL:4	RC:8	DC:8
------	------	------	------	--------------	--------	------	------	--------	------	------

Fields shown in the packet format and not specified in the following paragraphs shall be set as specified in 5.2.5.2.1.

5.2.5.2.10.1.2 *Data packet type (DP)*. This field shall be set to 0.

5.2.5.2.10.1.3 *MSP packet type (MP)*. This field shall be set to 1.

5.2.5.2.10.1.4 *Supervisory packet (SP)*. This field shall be set to 2.

5.2.5.2.10.1.5 *Supervisory type (ST)*. This field shall be set to 2.

5.2.5.2.10.1.6 *Reset cause code (RC) and diagnostic code (DC)*. The reset cause and diagnostic codes used in the Mode S RESET REQUEST packet shall be as specified in the ISO 8208 packet when the reset procedure is initiated by the DTE. If the reset procedure originates with the DCE, the DCE state tables shall specify the diagnostic fields coding. In this case, bit 8 of the reset cause field shall be set to 0.

5.2.5.2.10.2 *Translation into ISO 8208 packets*. Reception by the XDLP reformatting process of a Mode S RESET packet from the local XDCE shall result in the generation of a corresponding ISO 8208 RESET packet to the local DCE. The translation from the Mode S packet to the ISO 8208 packet shall be the inverse of the processing defined in 5.2.5.2.10.1.

5.2.5.2.11 *ISO 8208 RESTART REQUEST to Mode S CLEAR REQUEST*. The receipt of an ISO 8208 RESTART REQUEST from the local DCE shall result in the reformatting process generating a Mode S CLEAR REQUEST by ADLP or Mode S CLEAR REQUEST by GDLP for all SVCs associated with the requesting DTE. The fields of the Mode S CLEAR REQUEST packets shall be set as specified in 5.2.5.2.5 and 5.2.5.2.6.

Note.— There are no restart states in the Mode S packet layer protocol.

5.2.5.3 PACKETS LOCAL TO THE MODE S SUBNETWORK

Note.— Packets defined in this section do not result in the generation of an ISO 8208 packet.

5.2.5.3.1 *MODE S RECEIVE READY*

5.2.5.3.1.1 *Packet format.* The Mode S RECEIVE READY packet arriving from an XDLP is not related to the control of the DTE/DCE interface and shall not cause the generation of an ISO 8208 packet. The format of the packet shall be as follows:

DP:1	MP:1	SP:2	ST:2	FILL2:0 or 2	FILL:2	SN:6	CH:4	PR:4
------	------	------	------	--------------	--------	------	------	------

Fields shown in the packet format and not specified in the following paragraphs shall be set as specified in 5.2.5.2.1. The packet shall be processed as specified in 5.2.6.5.

5.2.5.3.1.2 *Data packet type (DP).* This field shall be set to 0.

5.2.5.3.1.3 *MSP packet type (MP).* This field shall be set to 1.

5.2.5.3.1.4 *Supervisory packet (SP).* This field shall be set to 2.

5.2.5.3.1.5 *Supervisory type (ST).* This field shall be set to 0.

5.2.5.3.1.6 *Packet receive sequence number (PR).* This field shall be set as specified in 5.2.6.4.4.

5.2.5.3.2 *MODE S RECEIVE NOT READY*

5.2.5.3.2.1 *Packet format.* The Mode S RECEIVE NOT READY packet arriving from an XDLP is not related to the control of the DTE/DCE interface and shall not cause the generation of an ISO 8208 packet. The format of the packet shall be as follows:

DP:1	MP:1	SP:2	ST:2	FILL2:0 or 2	FILL:2	SN:6	CH:4	PR:4
------	------	------	------	--------------	--------	------	------	------

Fields shown in the packet format and not specified in the following paragraphs shall be set as specified in 5.2.5.2.1. The packet shall be processed as specified in 5.2.6.6.

5.2.5.3.2.2 *Data packet type (DP).* This field shall be set to 0.

5.2.5.3.2.3 *MSP packet type (MP).* This field shall be set to 1.

5.2.5.3.2.4 *Supervisory packet (SP).* This field shall be set to 2.

5.2.5.3.2.5 *Supervisory type (ST).* This field shall be set to 1.

5.2.5.3.2.6 *Packet receive sequence number (PR).* This field shall be set as specified in 5.2.6.4.4.

5.2.5.3.3 *MODE S ROUTE*

5.2.5.3.3.1 *Packet format.* The format for the packet shall be as follows:

DP:1	MP:1	SP:2	ST:2	OF:1	IN:1	RTL:8	RT:v	ODL:0 or 8	OD:v
------	------	------	------	------	------	-------	------	------------	------

Fields shown in the packet format and not specified in the following paragraphs shall be set as specified in 5.2.5.2.1. The packet shall only be generated by the GDLP. It shall be processed by the ADLP as specified in 5.2.8.1.2 and shall have a maximum size as specified in 5.2.6.4.2.1.

5.2.5.3.3.2 *Data packet type (DP)*. This field shall be set to 0.

5.2.5.3.3.3 *MSP packet type (MP)*. This field shall be set to 1.

5.2.5.3.3.4 *Supervisory packet (SP)*. This field shall be set to 3.

5.2.5.3.3.5 *Supervisory type (ST)*. This field shall be set to 0.

5.2.5.3.3.6 *Option flag (OF)*. This field shall indicate the presence of the optional data length (ODL) and optional data (OD) fields. OF shall be set to 1 if ODL and OD are present. Otherwise it shall be set to 0.

5.2.5.3.3.7 *Initialization bit (IN)*. This field shall indicate the requirement for subnetwork initialization. It shall be set by the GDLP as specified in 5.2.8.1.2 d).

Note.— Initialization causes the clearing of any open SVCs associated with the DTE addresses contained in the ROUTE packet. This is needed to assure that all channels are closed at acquisition and for initialization following recovery after a GDLP failure.

5.2.5.3.3.8 *Route table length (RTL)*. This field shall indicate the size of the route table, expressed in bytes.

5.2.5.3.3.9 *Route table (RT)*

5.2.5.3.3.9.1 *Contents*. This table shall consist of a variable number of entries each containing information specifying the addition or deletion of entries in the II code-DTE cross-reference table (5.2.8.1.1).

5.2.5.3.3.9.2 *Entries*. Each entry in the route table shall consist of the II code, a list of up to 8 ground DTE addresses, and a flag indicating whether the resulting II code-DTE pairs shall be added or deleted from the II code-DTE cross-reference table. A route table entry shall be coded as follows:

II:4	AD:1	ND:3	DAL:v
------	------	------	-------

5.2.5.3.3.9.3 *Interrogator identifier (II)*. This field shall contain the 4-bit II code.

5.2.5.3.3.9.4 *Add/delete flag (AD)*. This field shall indicate whether the II code-DTE pairs shall be added ($AD = 1$) or deleted ($AD = 0$) from the II code-DTE cross-reference table.

5.2.5.3.3.9.5 *Number of DTE addresses (ND)*. This field shall be expressed in binary in the range from 0 to 7 and shall indicate the number of DTE addresses present in DAL minus 1 (in order to allow from 1 to 8 DTE addresses).

5.2.5.3.3.9.6 *DTE address list (DAL)*. This list shall consist of up to 8 DTE addresses, expressed in 8-bit binary representation.

5.2.5.3.3.10 *Optional data length (ODL)*. This field shall contain the length in bytes of the following OD field.

5.2.5.3.3.11 *Optional data (OD)*. This variable length field shall contain optional data.

5.2.5.3.4 *MODE S CLEAR CONFIRMATION BY ADLP*

5.2.5.3.4.1 *Packet format*. The format for this packet shall be as follows:

DP:1	MP:1	SP:2	ST:2	FILL2:0 or 2	TC:2	SN:6	CH:4	AM:4	AG:8
------	------	------	------	--------------	------	------	------	------	------

Fields shown in the packet format and not specified in the following paragraphs shall be set as specified in 5.2.5.2.1 and 5.2.5.2.5. This packet shall be processed as specified in 5.2.6.3.

5.2.5.3.4.2 *Data packet type (DP)*. This field shall be set to 0.

5.2.5.3.4.3 *MSP packet type (MP)*. This field shall be set to 1.

5.2.5.3.4.4 *Supervisory packet (SP)*. This field shall be set to 1.

5.2.5.3.4.5 *Channel number (CH)*: If a channel number has been allocated during the call acceptance phase, then CH shall be set to that value, otherwise it shall be set to zero.

5.2.5.3.4.6 *Temporary channel (TC)*: If a channel number has been allocated during the call acceptance phase, then TC shall be set to zero, otherwise it shall be set to the value used in the CALL REQUEST by GDLP.

5.2.5.3.4.7 *Supervisory type (ST)*. This field shall be set to 3.

5.2.5.3.5 *MODE S CLEAR CONFIRMATION BY GDLP*

5.2.5.3.5.1 *Packet format*. The format for this packet shall be as follows:

DP:1	MP:1	SP:2	ST:2	FILL:2	TC:2	SN:6	CH:4	AM:4	AG:8
------	------	------	------	--------	------	------	------	------	------

Fields shown in the packet format and not specified in the following paragraphs shall be set as specified in 5.2.5.2.1 and 5.2.5.2.6. This packet shall be processed as specified in 5.2.6.3.

5.2.5.3.5.2 *Data packet type (DP)*. This field shall be set to 0.

5.2.5.3.5.3 *MSP packet type (MP)*. This field shall be set to 1.

5.2.5.3.5.4 *Supervisory packet (SP)*. This field shall be set to 1.

5.2.5.3.5.5 *Channel number (CH)*: If a channel number has been allocated during the call acceptance phase, then CH shall be set to that value, otherwise it shall be set to zero.

5.2.5.3.5.6 *Temporary channel (TC)*: If a channel number has been allocated during the call acceptance phase, then TC shall be set to zero, otherwise it shall be set to the value used in the CALL REQUEST by GDLP.

5.2.5.3.5.7 *Supervisory type (ST)*. This field shall be set to 3.

5.2.5.3.6 *MODE S RESET CONFIRMATION*

5.2.5.3.6.1 *Packet format*. The format for this packet shall be as follows:

DP:1	MP:1	SP:2	ST:2	FILL2:0 or 2	FILL:2	SN:6	CH:4	FILL:4
------	------	------	------	--------------	--------	------	------	--------

Fields shown in the packet format and not specified in the following paragraphs shall be set as specified in 5.2.5.2.1. This packet shall be processed as specified in Table 5-14.

5.2.5.3.6.2 *Data packet type (DP)*. This field shall be set to 0.

5.2.5.3.6.3 *MSP packet type (MP)*. This field shall be set to 1.

5.2.5.3.6.4 *Supervisory packet (SP)*. This field shall be set to 2.

5.2.5.3.6.5 *Supervisory type (ST)*. This field shall be set to 3.

5.2.5.3.7 *MODE S REJECT*

5.2.5.3.7.1 *Packet format*. The format for this packet shall be as follows:

DP:1	MP:1	SP:2	ST:2	SS:2	FILL:0 or 2	SN:6	CH:4	PR:4
------	------	------	------	------	-------------	------	------	------

Fields shown in the packet format and not specified in the following paragraphs shall be set as specified in 5.2.5.2.1. This packet shall be processed as specified in 5.2.6.8.

5.2.5.3.7.2 *Data packet type (DP)*. This field shall be set to 0.

5.2.5.3.7.3 *MSP packet type (MP)*. This field shall be set to 1.

5.2.5.3.7.4 *Supervisory packet (SP)*. This field shall be set to 3.

5.2.5.3.7.5 *Supervisory type (ST)*. This field shall be set to 3.

5.2.5.3.7.6 *Supervisory subset (SS)*. This field shall be set to 1.

5.2.5.3.7.7 *Packet receive sequence number (PR)*. This field shall be set as specified in 5.2.6.4.4.

5.2.6 XDCE operation

Note.— The ADCE process within the ADLP acts as a peer process to the GDCE process in the GDLP.

5.2.6.1 *State transitions*. The XDCE shall operate as a state machine. Upon entering a state, the XDCE shall perform the actions specified in Table 5-14. State transition and additional action(s) shall be as specified in Table 5-15 through Table 5-22.

Note 1.— The next state transition (if any) that occurs when the XDCE receives a packet from the peer XDCE is specified by Table 5-15 through Table 5-19. The same transitions are defined in Table 5-20 through Table 5-22 when the XDCE receives a packet from the DCE (via the reformatting process).

Note 2.— The XDCE state hierarchy is the same as for the DCE as presented in Figure 5-2, except that states r2, r3 and p5 are omitted.

5.2.6.2 DISPOSITION OF PACKETS

5.2.6.2.1 Upon receipt of a packet from the peer XDCE, the packet shall be forwarded or not forwarded to the DCE (via the reformatting process) according to the parenthetical instructions contained in Tables 5-15 to 5-19. If no parenthetical instruction is listed or if the parenthetical instruction indicates “do not forward” the packet shall be discarded.

5.2.6.2.2 Upon receipt of a packet from the DCE (via the reformatting process), the packet shall be forwarded or not forwarded to the peer XDCE according to the parenthetical instructions contained in Tables 5-20 to 5-22. If no parenthetical instruction is listed or if the parenthetical instruction indicates “do not forward” the packet shall be discarded.

5.2.6.3 SVC CALL SETUP AND CLEAR PROCEDURE

5.2.6.3.1 *Setup procedures.* Upon receipt of a CALL REQUEST from the DCE or peer XDCE, the XDLP shall determine if sufficient resources exist to operate the SVC. This shall include: sufficient buffer space (refer to 5.2.5.1.1 for buffer requirements) and an available *p1* state SVC. Upon acceptance of the CALL REQUEST from the DCE (via the reformatting process), the Mode S CALL REQUEST packet shall be forwarded to frame processing. Upon acceptance of a Mode S CALL REQUEST from the peer XDCE (via frame processing), the Mode S CALL REQUEST shall be sent to the reformatting process.

5.2.6.3.2 *Aborting a call request.* If the DTE and/or the peer XDCE abort a call before they have received a CALL ACCEPT packet, they shall indicate this condition by issuing a CLEAR REQUEST packet. Procedures for handling these cases shall be as specified in Table 5-16 and Table 5-20.

5.2.6.3.3 VIRTUAL CALL CLEARING

5.2.6.3.3.1 If the XDCE receives a Mode S CALL REQUEST from the reformatting process that it cannot support, it shall initiate a Mode S CLEAR REQUEST packet that is sent to the DCE (via the reformatting process) for transfer to the DTE (the DCE thus enters the DCE CLEAR REQUEST to DTE state, *p7*).

5.2.6.3.3.2 If the XDCE receives a Mode S CALL REQUEST packet from the peer XDCE (via frame processing) which it cannot support, it shall enter the state *p7*.

5.2.6.3.3.3 A means shall be provided to advise the DTE whether an SVC has been cleared due to the action of the peer DTE or due to a problem within the subnetwork itself.

5.2.6.3.3.4 **Recommendation.**— *The requirement of 5.2.6.3.3.3 should be satisfied by setting bit 8 of the cause field to 1 to indicate that the problem originated in the Mode S subnetwork and not in the DTE. The diagnostic and cause codes should be set as follows:*

- a) *no channel number available, DC = 71, CC = 133;*
- b) *buffer space not available, DC = 71, CC = 133;*
- c) *DTE not operational, DC = 162, CC = 141; and*
- d) *link failure, DC = 225, CC = 137.*

5.2.6.3.3.5 If the ADLP receives a Mode S ROUTE packet with the IN bit set to ONE, the ADLP shall perform local initialization by clearing Mode S SVCs associated with the DTE addresses contained in the ROUTE packet. If the GDLP receives a search request (Table 5-23) from an ADLP, the GDLP shall perform local initialization by clearing Mode S SVCs associated with that ADLP. Local initialization shall be accomplished by:

- a) releasing all allocated resources associated with these SVCs (including the resequencing buffers);
- b) returning these SVCs to the ADCE ready state (*p1*); and
- c) sending Mode S CLEAR REQUEST packets for these SVCs to the DCE (via the reformatting process) for transfer to the DTE.

Note.— This action will allow all ISO 8208 SVCs attached to the Mode S SVCs to be cleared and return to their ready states (*p1*).

5.2.6.3.4 *Clear confirmation.* When the XDCE receives a Mode S CLEAR CONFIRMATION packet, the remaining allocated resources to manage the SVC shall be released (including the resequencing buffers) and the SVC shall be returned to the *p1* state. Mode S CLEAR CONFIRMATION packets shall not be transferred to the reformatting process.

5.2.6.3.5 *Clear collision.* A clear collision occurs at the XDCE when it receives a Mode S CLEAR REQUEST packet from the DCE (via the reformatting process) and then receives a Mode S CLEAR REQUEST packet from the peer XDCE (or vice versa). In this event, the XDCE does not expect to receive a Mode S CLEAR CONFIRMATION packet for this SVC and shall consider the clearing complete.

5.2.6.3.6 *Packet processing.* The XDCE shall treat an S-bit sequence of Mode S CALL REQUEST, CALL ACCEPT and CLEAR REQUEST packets as a single entity.

5.2.6.4 DATA TRANSFER AND INTERRUPT PROCEDURES

5.2.6.4.1 GENERAL PROVISIONS

5.2.6.4.1.1 Data transfer and interrupt procedures shall apply independently to each SVC. The contents of the user data field shall be passed transparently to the DCE or to the peer XDCE. Data shall be transferred in the order dictated by the sequence numbers assigned to the data packets.

5.2.6.4.1.2 To transfer DATA packets, the SVC shall be in a FLOW CONTROL READY state (*d1*).

5.2.6.4.2 MODE S PACKET SIZE

5.2.6.4.2.1 The maximum size of Mode S packets shall be 152 bytes in the uplink direction and 160 bytes in the downlink direction for installations that have full uplink and downlink ELM capability. The maximum downlink packet size for level four transponders with less than 16 segment downlink ELM capability shall be 10 bytes times the maximum number of downlink ELM segments that the transponder specifies in its data link capability report. If there is no ELM capability, the maximum Mode S packet size shall be 28 bytes.

5.2.6.4.2.2 The Mode S subnetwork shall allow packets of less than the maximum size to be transferred.

5.2.6.4.3 FLOW CONTROL WINDOW SIZE

5.2.6.4.3.1 The flow control window size of the Mode S subnetwork shall be independent of that used on the DTE/DCE interface. The Mode S subnetwork window size shall be 15 packets in the uplink and downlink directions.

5.2.6.4.4 SVC FLOW CONTROL

5.2.6.4.4.1 Flow control shall be managed by means of a sequence number for received packets (PR) and one for packets that have been sent (PS). A sequence number (PS) shall be assigned for each Mode S DATA packet generated by the XDLP for each SVC. The first Mode S DATA packet transferred by the XDCE to frame processing when the SVC has just

entered the flow control ready state shall be numbered zero. The first Mode S packet received from the peer XDCE after an SVC has just entered the flow control ready state shall be numbered zero. Subsequent packets shall be numbered consecutively.

5.2.6.4.4.2 A source of Mode S DATA packets (the ADCE or GDCE) shall not send (without permission from the receiver) more Mode S DATA packets than would fill the flow control window. The receiver shall give explicit permission to send more packets.

5.2.6.4.4.3 The permission information shall be in the form of the next expected packet sequence number and shall be denoted PR. If a receiver wishes to update the window and it has data to transmit to the sender, a Mode S DATA packet shall be used for information transfer. If the window must be updated and no data are to be sent, a Mode S RECEIVE READY (RR) or Mode S RECEIVE NOT READY (RNR) packet shall be sent. At this point, the “sliding window” shall be moved to begin at the new PR value. The XDCE shall now be authorized to transfer more packets without acknowledgement up to the window limit.

5.2.6.4.4.4 When the sequence number (PS) of the next Mode S DATA packet to be sent is in the range $PR \leq PS \leq PR + 14$ (modulo 16), the sequence number shall be defined to be “in the window” and the XDCE shall be authorized to transmit the packet. Otherwise, the sequence number (PS) of the packet shall be defined to be “outside the window” and the XDCE shall not transmit the packet to the peer XDCE.

5.2.6.4.4.5 When the sequence number (PS) of the packet received is next in sequence and within the window, the XDCE shall accept this packet. Receipt of a packet with a PS:

- a) outside the window; or
- b) out of sequence; or
- c) not equal to 0 for the first data packet after entering FLOW CONTROL READY state (*d1*);

shall be considered an error (5.2.6.8).

5.2.6.4.4.6 The receipt of a Mode S DATA packet with a valid PS number (i.e. the next PS in sequence) shall cause the lower window PR to be changed to that PS value plus 1. The packet receive sequence number (PR) shall be conveyed to the originating XDLP by a Mode S DATA, RECEIVE READY, RECEIVE NOT READY, or REJECT packet. A valid PR value shall be transmitted by the XDCE to the peer XDCE after the receipt of 8 packets provided that sufficient buffer space exists to store 15 packets. Incrementing the PR and PS fields shall be performed using modulo 16 arithmetic.

Note.— The loss of a packet which contains the PR value may cause the ADLP/GDLP operations for that SVC to cease.

5.2.6.4.4.7 A copy of a packet shall be retained until the user data has been successfully transferred. Following successful transfer, the PS value shall be updated.

5.2.6.4.4.8 The PR value for user data shall be updated as soon as the required buffer space for the window (as determined by flow control management) is available within the DCE.

5.2.6.4.4.9 Flow control management shall be provided between the DCE and XDCE.

5.2.6.4.5 INTERRUPT PROCEDURES FOR SWITCHED VIRTUAL CIRCUITS

5.2.6.4.5.1 If user data is to be sent via the Mode S subnetwork without following the flow control procedures, the interrupt procedures shall be used. The interrupt procedure shall have no effect on the normal data packet and flow control procedures. An interrupt packet shall be delivered to the DTE (or the transponder or interrogator interface) at or before the

point in the stream of data at which the interrupt was generated. The processing of a Mode S INTERRUPT packet shall occur as soon as it is received by the XDCE.

Note.— The use of clear, reset, and restart procedures can cause interrupt data to be lost.

5.2.6.4.5.2 The XDCE shall treat an S-bit sequence of Mode S INTERRUPT packets as a single entity.

5.2.6.4.5.3 Interrupt processing shall have precedence over any other processing for the SVC occurring at the time of the interrupt.

5.2.6.4.5.4 The reception of a Mode S INTERRUPT packet before the previous interrupt of the SVC has been confirmed (by the receipt of a Mode S INTERRUPT CONFIRMATION packet) shall be defined as an error. The error results in a reset (see Table 5-18).

5.2.6.5 RECEIVE READY PROCEDURE

5.2.6.5.1 The Mode S RECEIVE READY packet shall be sent if no Mode S DATA packets (that normally contain the updated PR value) are available for transmittal and it is necessary to transfer the latest PR value. It also shall be sent to terminate a receiver not ready condition.

5.2.6.5.2 Receipt of the Mode S RECEIVE READY packet by the XDCE shall cause the XDCE to update its value of PR for the outgoing SVC. It shall not be taken as a demand for retransmission of packets that have already been transmitted and are still in the window.

5.2.6.5.3 Upon receipt of the Mode S RECEIVE READY packet, the XDCE shall go into the ADLP(GDLP) RECEIVE READY state (g1).

5.2.6.6 RECEIVE NOT READY PROCEDURE

5.2.6.6.1 The Mode S RECEIVE NOT READY packet shall be used to indicate a temporary inability to accept additional DATA packets for the given SVC. The Mode S RNR condition shall be cleared by the receipt of a Mode S RR packet or a Mode S REJECT packet.

5.2.6.6.2 When the XDCE receives a Mode S RECEIVE NOT READY packet from the peer XDCE, it shall update its value of PR for the SVC and stop transmitting Mode S DATA packets on the SVC to the XDLP. The XDCE shall go into the ADLP(GDLP) RECEIVE NOT READY state (g2).

5.2.6.6.3 The XDCE shall transmit a Mode S RECEIVE NOT READY packet to the peer XDCE if it is unable to receive from the peer XDCE any more Mode S DATA packets on the indicated SVC. Under these conditions, the XDCE shall go into the ADCE(GDCE) RECEIVE NOT READY state (f2).

5.2.6.7 RESET PROCEDURE

5.2.6.7.1 When the XDCE receives a Mode S RESET REQUEST packet from either the peer XDCE or the DCE (via the reformatting process) or due to an error condition performs its own reset, the following actions shall be taken:

- a) those Mode S DATA packets that have been transmitted to the peer XDCE shall be removed from the window;
- b) those Mode S DATA packets that are not transmitted to the peer XDCE but are contained in an M-bit sequence for which some packets have been transmitted shall be deleted from the queue of DATA packets awaiting transmission;

- c) those Mode S DATA packets received from the peer XDCE that are part of an incomplete M-bit sequence shall be discarded;
- d) the lower window edge shall be set to 0 and the next packet sent shall have a sequence number (PS) of 0;
- e) any outstanding Mode S INTERRUPT packets to or from the peer XDCE shall be left unconfirmed;
- f) any Mode S INTERRUPT packet awaiting transfer shall be discarded;
- g) data packets awaiting transfer shall not be discarded (unless they are part of a partially transferred M-bit sequence); and
- h) the transition to $d1$ shall also include a transition to $i1, j1, f1$ and $g1$.

5.2.6.7.2 The reset procedure shall apply to the DATA TRANSFER state ($p4$). The error procedure in Table 5-16 shall be followed. In any other state the reset procedure shall be abandoned.

5.2.6.8 REJECT PROCEDURE

5.2.6.8.1 When the XDCE receives a Mode S DATA packet from the peer XDCE with incorrect format or whose packet sequence number (PS) is not within the defined window (Table 5-19) or is out of sequence, it shall discard the received packet and send a Mode S REJECT packet to the peer XDCE via frame processing. The Mode S REJECT packet shall indicate a value of PR for which retransmission of the Mode S DATA packets is to begin. The XDCE shall discard subsequent out-of-sequence Mode S DATA packets whose receipt occurs while the Mode S REJECT packet response is still outstanding.

5.2.6.8.2 When the XDCE receives a Mode S REJECT packet from the peer XDCE, it shall update its lower window value with the new value of PR and begin to (re)transmit packets with a sequence number of PR.

5.2.6.8.3 Reject indications shall not be transferred to the DCE. If the ISO 8208 interface supports the reject procedures, the reject indications occurring on the ISO 8208 interface shall not be transferred between the DCE and the XDCE.

5.2.6.9 PACKET RESEQUENCING AND DUPLICATE SUPPRESSION

Note 1.— If the frames for an SVC include both types (SLM and ELM), the sequence of packets may be lost due to the different delivery times. The order may also be lost if multiple interrogators are used to deliver frames for the same SVC to a given XDLP. The following procedure will correct for a limited amount of desequencing.

Note 2.— This process serves as an interface between frame processing and the XDCE function.

5.2.6.9.1 *Resequencing.* Resequencing shall be performed independently for the uplink and downlink transfers of each Mode S SVC. The following variables and parameters shall be used:

SNRA 6-bit variable indicating the sequence number of a received packet on a specific SVC. It is contained in the SN field of the packet (5.2.5.2.1.1.7).

NESN The next expected sequence number following a series of consecutive sequence numbers.

HSNR The highest value of SNR in the resequencing window.

Tq Resequencing timers (see Tables 5-1 and 5-13) associated with a specific SVC.

All operations involving the sequence number (SN) shall be performed modulo 64.

5.2.6.9.2 *Duplication window.* The range of SNR values between $NESN - 32$ and $NESN - 1$ inclusive shall be denoted the duplication window.

5.2.6.9.3 *Resequencing window.* The range of SNR values between $NESN + 1$ and $NESN + 31$ inclusive shall be denoted the resequencing window. Received packets with a sequence number value in this range shall be stored in the resequencing window in sequence number order.

5.2.6.9.4 TRANSMISSION FUNCTIONS

5.2.6.9.4.1 For each SVC, the first packet sent to establish a connection (the first Mode S CALL REQUEST or first Mode S CALL ACCEPT packet) shall cause the value of the SN field to be initialized to zero. The value of the SN field shall be incremented after the transmission (or retransmission) of each packet.

5.2.6.9.4.2 The maximum number of unacknowledged sequence numbers shall be 32 consecutive SN numbers. Should this condition be reached, then it shall be treated as an error and the channel cleared.

Note.— A limit on the number of unacknowledged packets is required since the SN field is six bits long and therefore has a maximum of 64 different values before the values repeat.

5.2.6.9.5 RECEIVE FUNCTIONS

5.2.6.9.5.1 *Resequencing.* The resequencing algorithm shall maintain the variables HSNR and NESN for each SVC. NESN shall be initialized to 0 for all SVCs and shall be reset to 0 when the SVC re-enters the channel number pool (5.2.5.1.2).

5.2.6.9.5.2 *Processing of packets within the duplication window.* If a packet is received with a sequence number value within the duplication window, the packet shall be discarded.

5.2.6.9.5.3 *Processing of packets within the resequencing window.* If a packet is received with a sequence number within the resequencing window, it shall be discarded as a duplicate if a packet with the same sequence number has already been received and stored in the resequencing window. Otherwise, the packet shall be stored in the resequencing window. Then, if no Tq timers are running, HSNR shall be set to the value of SNR for this packet and a Tq timer shall be started with its initial value (Tables 5-1 and 5-13). If at least one Tq timer is running, and SNR is not in the window between NESN and HSNR + 1 inclusive, a new Tq timer shall be started and the value of HSNR shall be updated. If at least one Tq timer is running, and SNR for this packet is equal to HSNR + 1, the value of HSNR shall be updated.

5.2.6.9.5.4 *Release of packets to the XDCE.* If a packet is received with a sequence number equal to NESN, the following procedure shall be applied:

- a) the packet and any packets already stored in the resequencing window up to the next missing sequence number shall be passed to the XDCE;
- b) NESN shall be set to 1 + the value of the sequence number of the last packet passed to the XDCE; and
- c) the Tq timer associated with any of the released packets shall be stopped.

5.2.6.9.6 *Tq timer expiration.* If a Tq timer expires, the following procedure shall be applied:

- a) NESN shall be incremented until the next missing sequence number is detected after that of the packet associated with the Tq timer that has expired;

- b) any stored packets with sequence numbers that are no longer in the resequencing window shall be forwarded to the XDCE except that an incomplete S-bit sequence shall be discarded; and
- c) the T_q timer associated with any released packets shall be stopped.

5.2.7 Mode S specific services processing

Mode S specific services shall be processed by an entity in the XDLP termed the Mode S specific services entity (SSE). Transponder registers shall be used to convey the information specified in Table 5-24. The data structuring of the registers in Table 5-24 shall be implemented in such a way that interoperability is ensured.

Note 1.— The data formats and protocols for messages transferred via Mode S specific services are specified in the Technical Provisions for Mode S Services and Extended Squitter (Doc 9871) (in preparation).

Note 2.— Uniform implementation of the data formats and protocols for messages transferred via Mode S specific services will ensure interoperability.

Note 3.— This section describes the processing of control and message data received from the Mode S specific services interface.

Note 4.— Control data consists of information permitting the determination of, for example, message length, BDS code used to access the data format for a particular register, and aircraft address.

5.2.7.1 ADLP PROCESSING

5.2.7.1.1 DOWNLINK PROCESSING

5.2.7.1.1.1 *Specific services capability.* The ADLP shall be capable of receiving control and message data from the Mode S specific services interface(s) and sending delivery notices to this interface. The control data shall be processed to determine the protocol type and the length of the message data. When the message or control data provided at this interface are erroneous (i.e. incomplete, invalid or inconsistent), the ADLP shall discard the message and deliver an error report at the interface.

Note.— The diagnostic content and error reporting mechanism are a local issue.

5.2.7.1.1.2 *Broadcast processing.* The control and message data shall be used to format the Comm-B broadcast message as specified in 5.2.7.5 and transferred to the transponder.

5.2.7.1.1.3 *GICB processing.* The 8-bit BDS code shall be determined from the control data. The 7-byte register content shall be extracted from the received message data. The register content shall be transferred to the transponder, along with an indication of the specified register number. A request to address one of the air-initiated Comm-B registers or the airborne collision avoidance system (ACAS) active resolution advisories register shall be discarded. The assignment of registers shall be as specified in Table 5-24.

Note.— Provision of the data available in transponder registers 40, 50 and 60 {HEX} has been mandated in some ICAO Regions in support of ATM applications.

5.2.7.1.1.4 MSP processing

5.2.7.1.1.4.1 The MSP message length, channel number (M/CH) (5.2.7.3.1.3) and optionally the interrogator identifier (II) code shall be determined from the control data. The MSP message content shall be extracted from the received

message data. If the message length is 26 bytes or less, the SSE shall format an air-initiated Comm-B message (5.2.7.1.1.4.2) for transfer to the transponder using the short form MSP packet (5.2.7.3.1). If the message length is 27 to 159 bytes and the transponder has adequate downlink ELM capability, the SSE shall format an ELM message for transfer using the short form MSP packet. If the message length is 27 to 159 bytes and the transponder has a limited downlink ELM capability, the SSE shall format multiple long form MSP packets (5.2.7.3.2) using ELM messages, as required utilizing the L-bit and M/SN fields for association of the packets. If the message length is 27 to 159 bytes and the transponder does not have downlink ELM capability, the SSE shall format multiple long form MSP packets (5.2.7.3.2) using air initiated Comm-B messages, as required utilizing the L-bit and M/SN fields for association of the packets. Different frame types shall never be used in the delivery of an MSP message. Messages longer than 159 bytes shall be discarded. The assignment of downlink MSP channel numbers shall be as specified in Table 5-25.

5.2.7.1.1.4.2 For an MSP, a request to send a packet shall cause the packet to be multisite-directed to the interrogator which II code is specified in control data. If no II code is specified, the packet shall be downlinked using the air-initiated protocol. A message delivery notice for this packet shall be provided to the Mode S specific interface when the corresponding close-out(s) have been received from the transponder. If a close-out has not been received from the transponder in T_z seconds, as specified in Table 5-1, the MSP packet shall be discarded. This shall include the cancellation in the transponder of any frames associated with this packet. A delivery failure notice for this message shall be provided to the Mode S specific services interface.

5.2.7.1.2 UPLINK PROCESSING

Note.— This section describes the processing of Mode S specific services messages received from the transponder.

5.2.7.1.2.1 *Specific services capability.* The ADLP shall be capable of receiving Mode S specific services messages from the transponder via frame processing. The ADLP shall be capable of delivering the messages and the associated control data at the specific services interface. When the resources allocated at this interface are insufficient to accommodate the output data, the ADLP shall discard the message and deliver an error report at this interface.

Note.— The diagnostic content and the error reporting mechanism are a local issue.

5.2.7.1.2.2 *Broadcast processing.* If the received message is a broadcast Comm-A, as indicated by control data received over the transponder/ADLP interface, the broadcast ID and user data (5.2.7.5) shall be forwarded to the Mode S specific services interface (5.2.3.2.1) along with the control data that identifies this as a broadcast message. The assignment of uplink broadcast identifier numbers shall be as specified in Table 5-23.

5.2.7.1.2.3 *MSP processing.* If the received message is an MSP, as indicated by the packet format header (5.2.7.3), the user data field of the received MSP packet shall be forwarded to the Mode S specific services interface (5.2.3.2.1) together with the MSP channel number (M/CH), the IIS subfield (5.2.2.1.1.1) together with control data that identifies this as an MSP message. L-bit processing shall be performed as specified in 5.2.7.4. The assignment of uplink MSP channel numbers shall be as specified in Table 5-25.

5.2.7.2 GDLP PROCESSING

5.2.7.2.1 UPLINK PROCESSING

5.2.7.2.1.1 *Specific services capability.* The GDLP shall be capable of receiving control and message data from the Mode S specific services interface(s) (5.2.3.2.2) and sending delivery notices to the interface(s). The control data shall be processed to determine the protocol type and the length of the message data.

5.2.7.2.1.2 *Broadcast processing.* The GDLP shall determine the interrogator(s), broadcast azimuths and scan times from the control data and format the broadcast message for transfer to the interrogator(s) as specified in 5.2.7.5.

5.2.7.2.1.3 *GICB processing.* The GDLP shall determine the register number and the aircraft address from the control data. The aircraft address and BDS code shall be passed to the interrogator as a request for a ground-initiated Comm-B.

5.2.7.2.1.4 *MSP processing.* The GDLP shall extract from the control data the message length, the MSP channel number (M/CH) and the aircraft address, and obtain the message content from the message data. If the message length is 27 bytes or less, the SSE shall format a Comm-A message for transfer to the interrogator using the short form MSP packet (5.2.7.3.1). If the message length is 28 to 151 bytes and the transponder has uplink ELM capability, the SSE shall format an ELM message for transfer to the interrogator using the short form MSP packet. If the message length is 28 to 151 bytes and the transponder does not have uplink ELM capability, the SSE shall format multiple long form MSP packets (5.2.7.3.2) utilizing the L-bit and the M/SN fields for association of the packets. Messages longer than 151 bytes shall be discarded. The interrogator shall provide a delivery notice to the Mode S specific services interface(s) indicating successful or unsuccessful delivery, for each uplinked packet.

5.2.7.2.2 DOWNLINK PROCESSING

5.2.7.2.2.1 *Specific services capability.* The GDLP shall be capable of receiving Mode S specific services messages from the interrogator via frame processing.

5.2.7.2.2.2 *Broadcast processing.* If the received message is a broadcast Comm-B, as indicated by the interrogator/GDLP interface, the GDLP shall:

- a) generate control data indicating the presence of a broadcast message and the 24-bit address of the aircraft from which the message was received;
- b) append the 7-byte MB field of the broadcast Comm-B; and
- c) forward this data to the Mode S specific services interface(s) (5.2.3.2.2).

5.2.7.2.2.3 *GICB processing.* If the received message is a GICB, as indicated by the interrogator/GDLP interface, the GDLP shall:

- a) generate control data indicating the presence of a GICB message, the register number and the 24-bit address of the aircraft from which the message was received;
- b) append the 7-byte MB field of the GICB; and
- c) forward this data to the Mode S specific services interface(s) (5.2.3.2.2).

5.2.7.2.2.4 *MSP processing.* If the received message is an MSP as indicated by the packet format header (5.2.7.3), the GDLP shall:

- a) generate control data indicating the transfer of an MSP, the length of the message, the MSP channel number (M/CH) and the 24-bit address of the aircraft from which the message was received;
- b) append the user data field of the received MSP packet; and
- c) forward this data to the Mode S specific services interface(s) (5.2.3.2.2).

L-bit processing shall be performed as specified in 5.2.7.4.

5.2.7.3 MSP PACKET FORMATS

5.2.7.3.1 *Short form MSP packet.* The format for this packet shall be as follows:

DP:1	MP:1	M/CH:6	FILL1:0 or 6	UD:v
------	------	--------	--------------	------

5.2.7.3.1.1 *Data packet type (DP).* This field shall be set to 0.

5.2.7.3.1.2 *MSP packet type (MP).* This field shall be set to 0.

5.2.7.3.1.3 *MSP channel number (M/CH).* The field shall be set to the channel number derived from the SSE control data.

5.2.7.3.1.4 *Fill field (FILL1:0 or 6).* The fill length shall be 6 bits for a downlink SLM frame. Otherwise the fill length shall be 0.

5.2.7.3.1.5 *User data (UD).* The user data field shall contain message data received from the Mode S specific services interface (5.2.3.2.2).

5.2.7.3.2 *Long form MSP packet.* The format for this packet shall be as follows:

DP:1	MP:1	SP:2	L:1	M/SN:3	FILL2:0 or 2	M/CH:6	UD:v
------	------	------	-----	--------	--------------	--------	------

Fields shown in the packet format and not specified in the following paragraphs shall be set as specified in 5.2.5.2.1 and 5.2.7.3.1.

5.2.7.3.3 *Data packet type (DP).* This field shall be set to 0.

5.2.7.3.3.1 *MSP packet type (MP).* This field shall be set to 1.

5.2.7.3.3.2 *Supervisory packet (SP).* This field shall be set to 0.

5.2.7.3.3.3 *L field (L).* A value of 1 shall indicate that the packet is part of an L-bit sequence with more packets in the sequence to follow. A value of 0 shall indicate that the sequence ends with this packet.

5.2.7.3.3.4 *MSP sequence number field (M/SN).* This field shall be used to detect duplication in the delivery of L-bit sequences. The first packet in an L-bit sequence shall be assigned a sequence number of 0. Subsequent packets shall be numbered sequentially. A packet received with the same sequence number as the previously received packet shall be discarded.

5.2.7.4 *L-bit processing.* L-bit processing shall be performed only on the long form MSP packet and shall be performed as specified for M-bit processing (5.2.5.1.4.1) except as specified in the following paragraphs.

5.2.7.4.1 Upon receipt of a long form MSP packet, the XDLP shall construct the user data field by:

- a) verifying that the packet order is correct using the M/SN field (5.2.7.3.2);
- b) assuming that the user data field in the MSP packet is the largest number of integral bytes that is contained within the frame;

- c) associating each user data field in an MSP packet received with a previous user data field in an MSP packet that has an L-bit value of 1; and

Note.— *Truncation of the user data field is not permitted as this is treated as an error condition.*

- d) if an error is detected in the processing of an MSP packet, the packet shall be discarded.

5.2.7.4.2 In the processing of an L-bit sequence, the XDLP shall discard any MSP packets that have duplicate M/SN values. The XDLP shall discard the entire L-bit sequence if a long form MSP packet is determined to be missing by use of the M/SN field.

5.2.7.4.3 The packets associated with any L-bit sequence whose reassembly is not completed in T_m seconds (Tables 5-1 and 5-13) shall be discarded.

5.2.7.5 BROADCAST FORMAT

5.2.7.5.1 *Uplink broadcast.* The format of the broadcast Comm-A shall be as follows: The 83-bit uplink broadcast shall be inserted in an uplink Comm-A frame. The MA field of the Comm-A frame shall contain the broadcast identifier specified in Table 5-23 in the first 8 bits, followed by the first 48 user data bits of the broadcast message. The last 27 user data bits of the broadcast message shall be placed in the 27 bits immediately following the UF field of the Comm-A frame.

5.2.7.5.2 *Downlink broadcast.* The format of broadcast Comm-B shall be as follows: The 56-bit downlink broadcast message shall be inserted in the MB field of the broadcast Comm-B. The MB field shall contain the broadcast identifier specified in Table 5-23 in the first 8 bits, followed by the 48 user data bits.

5.2.8 Mode S subnetwork management

5.2.8.1 INTERROGATOR LINK DETERMINATION FUNCTION

Note.— *The ADLP interrogator link determination function selects the II code of the Mode S interrogator through which a Mode S subnetwork packet may be routed to the desired destination ground DTE.*

5.2.8.1.1 *II code-DTE address correlation.* The ADLP shall construct and manage a Mode S interrogator-data terminal equipment (DTE) cross-reference table whose entries are Mode S interrogator identifier (II) codes and ground DTE addresses associated with the ground ATN routers or other ground DTEs. Each entry of the II code-DTE cross-reference table shall consist of the 4-bit Mode S II code and the 8-bit binary representation of the ground DTE.

Note 1.— *Due to the requirement for non-ambiguous addresses, a DTE address also uniquely identifies a GDLP.*

Note 2.— *An ATN router may have more than one ground DTE address.*

5.2.8.1.2 *Protocol.* The following procedures shall be used:

- a) when the GDLP initially detects the presence of an aircraft, or detects contact with a currently acquired aircraft through an interrogator with a new II code, the appropriate fields of the DATA LINK CAPABILITY report shall be examined to determine if, and to what level, the aircraft has the capability to participate in a data exchange. After positive determination of data link capability, the GDLP shall uplink one or more Mode S ROUTE packets as specified in 5.2.5.3.3. This information shall relate the Mode S II code with the ground DTE addresses accessible through that interrogator. The ADLP shall update the II code-DTE cross-reference table and then discard the Mode S ROUTE packet(s);

- b) a II code-DTE cross-reference table entry shall be deleted when commanded by a Mode S ROUTE packet or when the ADLP recognizes that the transponder has not been selectively interrogated by a Mode S interrogator with a given II code for T_s seconds by monitoring the IIS subfield in Mode S surveillance or Comm-A interrogations (Table 5-1);
- c) when the GDLP determines that modification is required to the Mode S interrogator assignment, it shall transfer one or more Mode S ROUTE packets to the ADLP. The update information contained in the Mode S ROUTE packet shall be used by the ADLP to modify its cross-reference table. Additions shall be processed before deletions;
- d) when the GDLP sends the initial ROUTE packet after acquisition of a Mode S data link-equipped aircraft, the IN bit shall be set to ONE. This value shall cause the ADLP to perform the procedures as specified in 5.2.6.3.3.3. Otherwise, the IN bit shall be set to ZERO;
- e) when the ADLP is initialized (e.g. after a power-up procedure), the ADLP shall issue a search request by sending a broadcast Comm-B message with broadcast identifier equal to 255 (FF₁₆, as specified in Table 5-23) and the remaining 6 bytes unused. On receipt of a search request, a GDLP shall respond with one or more Mode S ROUTE packets, clear all SVCs associated with the ADLP, as specified in 5.2.6.3.3, and discard the search request. This shall cause the ADLP to initialize the II code-DTE cross-reference table; and
- f) on receipt of an update request (Table 5-23), a GDLP shall respond with one or more Mode S ROUTE packets and discard the update request. This shall cause the ADLP to update the II code-DTE cross-reference table.

Note.— The update request may be used by the ADLP under exceptional circumstances (e.g. changeover to standby unit) to verify the contents of its II code-DTE cross-reference table.

5.2.8.1.3 PROCEDURES FOR DOWNLINKING MODE S PACKETS

5.2.8.1.3.1 When the ADLP has a packet to downlink, the following procedures shall apply:

- a) *CALL REQUEST packet.* If the packet to be transferred is a Mode S CALL REQUEST, the ground DTE address field shall be examined and shall be associated with a connected Mode S interrogator using the II code-DTE cross-reference table. The packet shall be downlinked using the multisite-directed protocol. A request to transfer a packet to a DTE address not in the cross-reference table shall result in the action specified in 5.2.6.3.3.1.
- b) *Other SVC packets.* For an SVC, a request to send a packet to a ground DTE shall cause the packet to be multisite-directed to the last Mode S interrogator used to successfully transfer (uplink or downlink) a packet to that DTE, provided that this Mode S interrogator is currently in the II code-DTE cross-reference table. Otherwise, an SVC packet shall be downlinked using the multisite-directed protocol to any other Mode S interrogator associated with the specified ground DTE address.

Level 5 transponders shall be permitted to use additional interrogators for downlink transfer as indicated in the II code-DTE cross-reference table.

5.2.8.1.3.2 A downlink frame transfer shall be defined to be successful if its Comm-B or ELM close-out is received from the transponder within T_z seconds as specified in Table 5-1. If the attempt is not successful and an SVC packet is to be sent, the II code-DTE cross-reference table shall be examined for another entry with the same called ground DTE address and a different Mode S II code. The procedure shall be retried using the multisite-directed protocol with the new Mode S interrogator. If there are no entries for the required called DTE, or all entries result in a failed attempt, a link failure shall be declared (5.2.8.3.1).

5.2.8.2 SUPPORT FOR THE DTE(S)

5.2.8.2.1 *GDLP connectivity reporting.* The GDLP shall notify the ground DTE(s) of the availability of a Mode S data link-equipped aircraft (“join event”). The GDLP shall also inform the ground DTEs when such an aircraft is no longer in contact via that GDLP (“leave event”). The GDLP shall provide for notification (on request) of all Mode S data link-equipped aircraft currently in contact with that GDLP. The notifications shall provide the ground ATN router with the subnetwork point of attachment (SNPA) address of the mobile ATN router, with the position of the aircraft and quality of service as optional parameters. The SNPA of the mobile ATN router shall be the DTE address formed by the aircraft address and a sub-address of 0 (5.2.3.1.3.2).

5.2.8.2.2 *ADLP connectivity reporting.* The ADLP shall notify all aircraft DTEs whenever the last remaining entry for a ground DTE is deleted from the II code-DTE cross-reference table (5.2.8.1.1). This notification shall include the address of this DTE.

5.2.8.2.3 *Communications requirements.* The mechanism for communication of changes in subnetwork connectivity shall be a confirmed service, such as the join/leave events that allow notification of the connectivity status.

5.2.8.3 ERROR PROCEDURES

5.2.8.3.1 *Link failure.* The failure to deliver a packet to the referenced XDLP after an attempt has been made to deliver this packet via all available interrogators shall be declared to be a link level failure. For an SVC, the XDCE shall enter the state *p1* and release all resources associated with that channel. This shall include the cancellation in the transponder of any frames associated with this SVC. A Mode S CLEAR REQUEST packet shall be sent to the DCE via the reformatting process and shall be forwarded by the DCE as an ISO 8208 packet to the local DTE as described in 5.2.6.3.3. On the aircraft side, the channel shall not be returned to the ADCE channel pool, i.e. does not return to the state *p1*, until *Tr* seconds after the link failure has been declared (Table 5-1).

5.2.8.3.2 ACTIVE CHANNEL DETERMINATION

5.2.8.3.2.1 *Procedure for d1 state.* The XDLP shall monitor the activity of all SVCs, not in a READY state (*p1*). If an SVC is in the (XDCE) FLOW CONTROL READY state (*d1*) for more than *Tx* seconds (the active channel timer, Tables 5-1 and 5-13) without sending a Mode S RR, RNR, DATA, or REJECT packet, then:

- a) if the last packet sent was a Mode S REJECT packet to which a response has not been received, then the XDLP shall resend that packet;
- b) otherwise, the XDLP shall send a Mode S RR or RNR packet as appropriate to the peer XDLP.

5.2.8.3.2.2 *Procedure for other states.* If an XDCE SVC is in the *p2*, *p3*, *p6*, *p7*, *d2* or *d3* state for more than *Tx* seconds, the link failure procedure of 5.2.8.3.1 shall be performed.

5.2.8.3.2.3 Link failure shall be declared if either a failure to deliver, or a failure to receive, keep-alive packets has occurred. In which case the channel shall be cleared.

5.2.9 The data link capability report

The data link capability report shall be as specified in Annex 10, Volume IV, 3.1.2.6.10.2.

5.2.10 System timers

- 5.2.10.1 The values for timers shall conform to the values given in Tables 5-1 and 5-13.
- 5.2.10.2 Tolerance for all timers shall be plus or minus one per cent.
- 5.2.10.3 Resolution for all timers shall be one second.

5.2.11 System requirements

5.2.11.1 *Data integrity.* The maximum bit error rates for data presented at the ADLP/transponder interface or the GDLP/interrogator interface measured at the local DTE/XDLP interface (and vice versa) shall not exceed 10^{-9} for undetected errors and 10^{-7} for detected errors.

Note.— *The maximum error rate includes all errors resulting from data transfers across the interfaces and from XDLP internal operation.*

5.2.11.2 TIMING

5.2.11.2.1 *ADLP timing.* ADLP operations shall not take longer than 0.25 seconds for regular traffic and 0.125 seconds for interrupt traffic. This interval shall be defined as follows:

- a) *Transponders with downlink ELM capability.* The time that the final bit of a 128-byte data packet is presented to the DCE for downlink transfer to the time that the final bit of the first encapsulating frame is available for delivery to the transponder.
- b) *Transponders with Comm-B capability.* The time that the final bit of a user data field of 24 bytes is presented to the DCE for downlink transfer to the time that the final bit of the last of the four Comm-B segments that forms the frame encapsulating the user data is available for delivery to the transponder.
- c) *Transponders with uplink ELM capability.* The time that the final bit of the last segment of an ELM of 14 Comm-C segments that contains a user data field of 128 bytes is received by the ADLP to the time that the final bit of the corresponding packet is available for delivery to the DTE.
- d) *Transponders with Comm-A capability.* The time that the final bit of the last segment of four linked Comm-A segments that contains a user data field of 25 bytes is received by the ADLP to the time that the final bit of the corresponding packet is available for delivery to the DTE.

5.2.11.2.2 GDLP TIMING

Recommendation.— *The total time delay across the GDLP, exclusive of transmission delay, should not be greater than 0.125 seconds.*

5.2.11.3 *Interface rate.* The physical interface between the ADLP and the transponder shall have a minimum bit rate of 100 kilobits per second.

5.3 DCE AND XDCE STATE TABLES

5.3.1 *State table requirements.* The DCE and XDCE shall function as specified in state Tables 5-3 to 5-22. State Tables 5-15 through 5-22 shall be applied to:

- a) ADLP state transitions when the XDCE or XDLP terms in parenthesis are omitted; and
- b) GDLP state transitions when the terms in parenthesis are used and the XDCE or XDLP preceding them are omitted.

5.3.2 *Diagnostic and cause codes.* The table entries for certain conditions indicate a diagnostic code that shall be included in the packet generated when entering the state indicated. The term, “D = ,” shall define the diagnostic code. When “A = DIAG”, the action taken shall be to generate an ISO 8208 DIAGNOSTIC packet and transfer it to the DTE; the diagnostic code indicated shall define the entry in the diagnostic field of the packet. The cause field shall be set as specified in 5.2.6.3.3. The reset cause field shall be set as specified in ISO 8208.

Note 1.— The tables provided below specify state requirements in the following order:

- 5-3 *DCE special cases*
- 5-4 *DTE effect on DCE restart states*
- 5-5 *DTE effect on DCE call setup and clearing states*
- 5-6 *DTE effect on DCE reset states*
- 5-7 *DTE effect on DCE interrupt transfer states*
- 5-8 *DTE effect on DCE flow control transfer states*
- 5-9 *XDCE effect on DCE restart states*
- 5-10 *XDCE effect on DCE call setup and clearing states*
- 5-11 *XDCE effect on DCE reset states*
- 5-12 *XDCE effect on DCE interrupt transfer states*
- 5-15 *GDLP (ADLP) effect on ADCE (GDCE) packet layer ready states*
- 5-16 *GDLP (ADLP) effect on ADCE (GDCE) call setup and clearing states*
- 5-17 *GDLP (ADLP) effect on ADCE (GDCE) reset states*
- 5-18 *GDLP (ADLP) effect on ADCE (GDCE) interrupt transfer states*
- 5-19 *GDLP (ADLP) effect on ADCE (GDCE) flow control transfer states*
- 5-20 *DCE effect on ADCE (GDCE) call setup and clearing states*
- 5-21 *DCE effect on ADCE (GDCE) reset states*
- 5-22 *DCE effect on ADCE (GDCE) interrupt transfer states*

Note 2.— All tables specify both ADLP and GDLP actions.

Note 3.— Within the Mode S subnetwork, states p6 and d2 are transient states.

Note 4.— References to “notes” in the state tables refer to table-specific notes that follow each state table.

Note 5.— All diagnostic and cause codes are interpreted as decimal numbers.

Note 6.— An SVC between an ADCE and a GDCE may be identified by a temporary and/or permanent channel number, as defined in 5.2.5.1.2.

5.4 MODE S PACKET FORMATS

5.4.1 *Formats.* The Mode S packet formats shall be as specified in Figures 5-3 to 5-22.

5.4.2 *Significance of control fields.* The structure of the format control fields used in Mode S packets shall be as specified in Figure 5-23. The significance of all control fields used in these packet formats shall be as follows:

<i>Field symbol</i>	<i>Definition</i>
AG	Address, Ground; the 8-bit binary representation of the ground DTE address (5.2.3.1.3.1)
AM	Address, Mobile; the 4-bit binary representation of the last two BCD digits of the mobile DTE address (5.2.3.1.3.2)
CC	Clearing cause as defined in ISO 8208
CH	Channel number (1 to 15)
DC	Diagnostic code as defined in ISO 8208
DP	Data packet type (Figure 5-23)
F	S-bit sequence, first packet flag
FILL	Fill field
FILL1	Has a length of 6 bits for a non-multiplexed packet in a downlink SLM frame; otherwise it is 0 bit
FILL2	Has a length of 0 bit for a non-multiplexed packet in a downlink SLM frame and for a multiplexing header; otherwise it is 2 bits
FIRST PACKET	The contents of the first of the multiplexed packets
FS	Fast select present
IN	Initialization bit
L	“More bit” for long-form MSP packets as specified in 5.2.7.4
LAST PACKET	The contents of the last of the multiplexed packets

LENGTH	The length of a multiplexed packet in bytes expressed as an unsigned binary number
LV	User data field length; number of user bytes as specified in 5.2.2.3.1
M	“More bit” for SVC DATA packets as specified in 5.2.5.1.4.1
M/CH	MSP channel number
MP	MSP packet type (Figure 5-23)
M/SN	Sequence number; the sequence number for the long form MSP packet
OD	Optional data
ODL	Optional data length
OF	Option flag
P	Priority field
PR	Packet receive sequence number
PS	Packet send sequence number
RC	Resetting cause code as defined in ISO 8208
RT	Route table as defined in 5.2.5.3.3.8
RTL	Route table length expressed in bytes
S	“More bit” for CALL REQUEST, CALL ACCEPT, CLEAR REQUEST and INTERRUPT packets as specified in 5.2.5.1.4.2
SN	Sequence number; the sequence number for this packet type
SP	Supervisory packet (Figure 5-23)
SS	Supervisory subset number (Figure 5-23)
ST	Supervisory type (Figure 5-23)
TC	Temporary channel number (1 to 3)
UD	User data field

TABLES FOR CHAPTER 5

Table 5-1. ADLP Mode S subnetwork timers

<i>Timer name</i>	<i>Timer label</i>	<i>Nominal value</i>	<i>Reference</i>
Channel retirement	<i>Tr</i>	600 s	5.2.8.3.1
Active channel-ADLP	<i>Tx</i>	420 s	5.2.8.3.2
Interrogator interrogation	<i>Ts</i>	60 s	5.2.8.1.2
Interrogator link	<i>Tz</i>	30 s	5.2.7.1.1.4.2, 5.2.8.1.3.2
Link frame cancellation	<i>Tc</i>	60 s	5.2.2.1.1.4.5
L-bit delivery-ADLP	<i>Tm</i>	120 s	5.2.7.4.3
Packet resequencing and S-bit delivery	<i>Tq</i>	60 s	5.2.6.9

Table 5-2. DCE actions at state transition

<i>DCE state</i>	<i>State definition</i>	<i>Action that shall be taken when entering the state</i>
<i>r1</i>	PACKET LEVEL READY	Return all SVCs to the <i>p1</i> state (see <i>p1</i> state explanation).
<i>r2</i>	DTE RESTART REQUEST	Return each SVC to the <i>p1</i> state (see <i>p1</i> state explanation). Issue a RESTART CONFIRMATION to the DTE.
<i>r3</i>	DCE RESTART REQUEST	Issue a RESTART REQUEST to the DTE. Unless entered via the <i>r2</i> state, send a RESTART REQUEST to the reformatting process.
<i>p1</i>	READY	Release all resources assigned to SVC. Break the correspondence between the DTE/DCE SVC and the ADCE/GDCE SVC (the ADCE/GDCE SVC may not yet be in the <i>p1</i> state).
<i>p2</i>	DTE CALL REQUEST	Determine if sufficient resources exist to support request; if so, allocate resources and forward CALL REQUEST packet to reformatting process; if not, enter DCE CLEAR REQUEST to DTE state (<i>p7</i>). Determination of resources and allocation is as defined in ISO 8208.
<i>p3</i>	DCE CALL REQUEST	Determine if sufficient resources exist to support request; if so allocate resources and forward CALL REQUEST packet to DTE; if not, send a CLEAR REQUEST packet to the reformatting process. Determination of resources and allocation is as defined in ISO 8208.
<i>p4</i>	DATA TRANSFER	No action.
<i>p5</i>	CALL COLLISION	Reassign outgoing call to another SVC (the DTE in its call collision state ignores the incoming call) and enter the DCE CALL REQUEST state (<i>p3</i>) for that new SVC. Enter the <i>p2</i> state to process the CALL REQUEST from the DTE.
<i>p6</i>	DTE CLEAR REQUEST	Release all resources assigned to SVC, send a CLEAR CONFIRMATION packet to the DTE and enter <i>p1</i> state.
<i>p7</i>	DCE CLEAR REQUEST to DTE	Forward CLEAR REQUEST packet to DTE.
<i>d1</i>	FLOW CONTROL READY	No action.
<i>d2</i>	DTE RESET REQUEST	Remove DATA packets transmitted to DTE from window; discard any DATA packets that represent partially transmitted M-bit sequences and discard any INTERRUPT packet awaiting transfer to the DTE; reset all window counters to 0; set any timers and retransmission parameters relating to DATA and INTERRUPT transfer to their initial value. Send RESET CONFIRMATION packet to DTE. Return SVC to <i>d1</i> state.
<i>d3</i>	DCE RESET REQUEST to DTE	Remove DATA packets transmitted to DTE from window; discard any DATA packets that represent partially transmitted M-bit sequences and discard any INTERRUPT packet awaiting transfer to the DTE; reset all window counters to 0; set any timers and retransmission parameters relating to DATA and INTERRUPT transfer to their initial value. Forward RESET REQUEST packet to DTE.

<i>DCE state</i>	<i>State definition</i>	<i>Action that shall be taken when entering the state</i>
<i>i1</i>	DTE INTERRUPT READY	No action.
<i>i2</i>	DTE INTERRUPT SENT	Forward INTERRUPT packet received from DTE to reformatting process.
<i>j1</i>	DCE INTERRUPT READY	No action.
<i>j2</i>	DCE INTERRUPT SENT	Forward INTERRUPT packet received from reformatting process to DTE.
<i>f1</i>	DCE RECEIVE READY	No action.
<i>f2</i>	DCE RECEIVE NOT READY	No action.
<i>g1</i>	DTE RECEIVE READY	No action.
<i>g2</i>	DTE RECEIVE NOT READY	No action.

Table 5-3. DCE special cases

<i>Received from DTE</i>	<i>DCE special cases Any state</i>
Any packet less than 2 bytes in length (including a valid data link level frame containing no packet)	A=DIAG D=38
Any packet with an invalid general format identifier	A=DIAG D=40
Any packet with a valid general format identifier and an assigned logical channel identifier (includes a logical channel identifier of 0)	See Table 5-4

Table 5-4. DTE effect on DCE restart states

Packet received from DTE	DCE restart states (see Note 5)		
	PACKET LEVEL READY (see Note 1) <i>r1</i>	DTE RESTART REQUEST <i>r2</i>	DCE RESTART REQUEST <i>r3</i>
Packets having a packet type identifier shorter than 1 byte and logical channel identifier not equal to 0	See Table 5-5	<i>A=ERROR</i> <i>S=r3</i> <i>D=38</i> (see Note 4)	<i>A=DISCARD</i>
Any packet, except RESTART, REGISTRATION (if supported) with a logical channel identifier of 0	<i>A=DIAG</i> <i>D=36</i>	<i>A=DIAG</i> <i>D=36</i>	<i>A=DIAG</i> <i>D=36</i>
Packet with a packet type identifier which is undefined or not supported by DCE	See Table 5-5	<i>A=ERROR</i> <i>S=r3</i> <i>D=33</i> (see Note 4)	<i>A=DISCARD</i>
RESTART REQUEST, RESTART CONFIRMATION, or REGISTRATION (if supported) packet with a logical channel identifier unequal to 0	See Table 5-5	<i>A=ERROR</i> <i>S=r3</i> <i>D=41</i> (see Note 4)	<i>A=DISCARD</i>
RESTART REQUEST	<i>A=NORMAL</i> (forward) <i>S=r2</i>	<i>A=DISCARD</i>	<i>A=NORMAL</i> <i>S=p1</i> or <i>d1</i> (see Note 2)
RESTART CONFIRMATION	<i>A=ERROR</i> <i>S=r3</i> <i>D=17</i> (see Note 6)	<i>A=ERROR</i> <i>S=r3</i> <i>D=18</i> (see Note 4)	<i>A=NORMAL</i> <i>S=p1</i> or <i>d1</i> (see Note 2)
RESTART REQUEST OR RESTART CONFIRMATION packet with a format error	<i>A=DIAG</i> <i>D=38, 39, 81</i> or <i>82</i>	<i>A=DISCARD</i>	<i>A=ERROR</i> <i>D=38, 39, 81</i> or <i>82</i>
REGISTRATION REQUEST or REGISTRATION CONFIRMATION packets (see Note 3)	<i>A=NORMAL</i>	<i>A=NORMAL</i>	<i>A=NORMAL</i>
REGISTRATION REQUEST or REGISTRATION CONFIRMATION packet with a format error (see Note 3)	<i>A=DIAG</i> <i>D=38, 39, 81</i> or <i>82</i>	<i>A=ERROR</i> <i>S=r3</i> <i>D=38, 39, 81</i> or <i>82</i> (see Note 4)	<i>A=ERROR</i> <i>D=38, 39, 81</i> or <i>82</i>
Call setup, call clearing, DATA, interrupt, flow control, or reset packet	See Table 5-5	<i>A=ERROR</i> <i>S=r3</i> <i>D=18</i>	<i>A=DISCARD</i>
NOTES:			
1. The Mode S subnetwork has no restart states. Receipt of a RESTART REQUEST causes the DCE to respond with a RESTART CONFIRMATION. The RESTART REQUEST packet is forwarded to the reformatting process, which issues clear requests for all SVCs associated with the DTE. The DCE enters the <i>r3</i> state only as a result of an error detected on the DTE/DCE interface.			
2. The SVC channels are returned to state <i>p1</i> , the permanent virtual circuits (PVC) channels are returned to state <i>d1</i> .			
3. The use of the registration facility is optional on the DTE/DCE interface.			
4. No action is taken within the Mode S subnetwork.			
5. Table entries are defined as follows: A = action to be taken, S = the state to be entered, D = the diagnostic code to be used in packets generated as a result of this action, DISCARD indicates that the received packet is to be cleared for the XDLP buffers, and INVALID indicates that the packet/state combination cannot occur.			
6. The error procedure consists of entering the <i>r3</i> state, and sending a RESTART REQUEST to the reformatting process.			

Table 5-5. DTE effect on DCE call setup and clearing states

Packet received from DTE	DCE call setup and clearing states (see Note 5)						
	READY <i>p1</i>	DTE CALL REQUEST <i>p2</i>	DCE CALL REQUEST <i>p3</i>	DATA TRANSFER <i>p4</i>	CALL COLLISION <i>p5</i> (see Notes 1 and 4)	DTE CLEAR REQUEST <i>p6</i>	DCE CLEAR REQUEST to DTE <i>p7</i>
Packets having a packet type identifier shorter than 1 byte	<i>A=ERROR</i> <i>S=p7</i> <i>D=38</i>	<i>A=ERROR</i> <i>S=p7</i> <i>D=38</i> (see Note 2)	<i>A=ERROR</i> <i>S=p7</i> <i>D=38</i> (see Note 2)	See Table 5-6	<i>A=ERROR</i> <i>S=p7</i> <i>D=38</i> (see Note 2)	<i>A=ERROR</i> <i>S=p7</i> <i>D=38</i> (see Note 2)	<i>A=DISCARD</i>
Packets having a packet type identifier which is undefined or not supported by DCE	<i>A=ERROR</i> <i>S=p7</i> <i>D=33</i>	<i>A=ERROR</i> <i>S=p7</i> <i>D=33</i> (see Note 2)	<i>A=ERROR</i> <i>S=p7</i> <i>D=33</i> (see Note 2)	See Table 5-6	<i>A=ERROR</i> <i>S=p7</i> <i>D=33</i> (see Note 2)	<i>A=ERROR</i> <i>S=p7</i> <i>D=33</i> (see Note 2)	<i>A=DISCARD</i>
RESTART REQUEST, RESTART CONFIRMATION or REGISTRATION packet with logical channel identifier unequal to 0	<i>A=ERROR</i> <i>S=p7</i> <i>D=41</i>	<i>A=ERROR</i> <i>S=p7</i> <i>D=41</i> (see Note 2)	<i>A=ERROR</i> <i>S=p7</i> <i>D=41</i> (see Note 2)	See Table 5-6	<i>A=ERROR</i> <i>S=p7</i> <i>D=41</i> (see Note 2)	<i>A=ERROR</i> <i>S=p7</i> <i>D=41</i> (see Note 2)	<i>A=DISCARD</i>
CALL REQUEST	<i>A=NORMAL</i> <i>S=p2</i> (forward)	<i>A=ERROR</i> <i>S=p7</i> <i>D=21</i> (see Note 2)	<i>A=NORMAL</i> <i>S=p5</i>	<i>A=ERROR</i> <i>S=p7</i> <i>D=23</i> (see Note 2)	<i>A=ERROR</i> <i>S=p7</i> <i>D=24</i> (see Note 2)	<i>A=ERROR</i> <i>S=p7</i> <i>D=25</i> (see Note 2)	<i>A=DISCARD</i>
CALL ACCEPT	<i>A=ERROR</i> <i>S=p7</i> <i>D=20</i>	<i>A=ERROR</i> <i>S=p7</i> <i>D=21</i> (see Note 2)	<i>A=NORMAL</i> <i>S=p4</i> (Forward) or <i>A=ERROR</i> <i>S=p7</i> <i>D=42</i> (see Notes 2 and 3)	<i>A=ERROR</i> <i>S=p7</i> <i>D=23</i> (see Note 2)	<i>A=ERROR</i> <i>S=p7</i> <i>D=24</i> (see Notes 2 and 4)	<i>A=ERROR</i> <i>S=p7</i> <i>D=25</i> (see Note 2)	<i>A=DISCARD</i>
CLEAR REQUEST	<i>A=NORMAL</i> <i>S=p6</i>	<i>A=NORMAL</i> <i>S=p6</i> (forward)	<i>A=NORMAL</i> <i>S=p6</i> (forward)	<i>A=NORMAL</i> <i>S=p6</i> (forward)	<i>A=NORMAL</i> <i>S=p6</i> (forward)	<i>A=DISCARD</i>	<i>A=NORMAL</i> <i>S=p1</i> (do not forward)
CLEAR CONFIRMATION	<i>A=ERROR</i> <i>S=p7</i> <i>D=20</i>	<i>A=ERROR</i> <i>S=p7</i> <i>D=21</i> (see Note 2)	<i>A=ERROR</i> <i>S=p7</i> <i>D=22</i> (see Note 2)	<i>A=ERROR</i> <i>S=p7</i> <i>D=23</i> (see Note 2)	<i>A=ERROR</i> <i>S=p7</i> <i>D=24</i> (see Note 2)	<i>A=ERROR</i> <i>S=p7</i> <i>D=25</i> (see Note 2)	<i>A=NORMAL</i> <i>S=p1</i> (do not forward)
DATA, interrupt, flow control or reset packets	<i>A=ERROR</i> <i>S=p7</i> <i>D=20</i>	<i>A=ERROR</i> <i>S=p7</i> <i>D=21</i> (see Note 2)	<i>A=ERROR</i> <i>S=p7</i> <i>D=22</i> (see Note 2)	See Table 5-6	<i>A=ERROR</i> <i>S=p7</i> <i>D=24</i> (see Note 2)	<i>A=ERROR</i> <i>S=p7</i> <i>D=25</i> (see Note 2)	<i>A=DISCARD</i>

Packet received from DTE	DCE call setup and clearing states (see Note 5)						
	READY p1	DTE CALL REQUEST p2	DCE CALL REQUEST p3	DATA TRANSFER p4	CALL COLLISION p5 (see Notes 1 and 4)	DTE CLEAR REQUEST p6	DCE CLEAR REQUEST to DTE p7
<p>NOTES:</p> <ol style="list-style-type: none"> 1. On entering the p5 state, the DCE reassigns the outgoing call to the DTE to another channel (no CLEAR REQUEST is issued) and responds to incoming DTE call as appropriate with a CLEAR REQUEST or CALL ACCEPT packet. 2. The error procedure consists of performing the actions specified when entering the p7 state (including sending a CLEAR REQUEST packet to the DTE) and additionally sending a CLEAR REQUEST packet to the XDCE (via the reformatting process). 3. The use of the fast select facility with a restriction on the response prohibits the DTE from sending a CALL ACCEPT packet. 4. The DTE in the event of a call collision must discard the CALL REQUEST packet received from the DCE. 5. Table entries are defined as follows: A = action to be taken, S = the state to be entered, D = the diagnostic code to be used in packets generated as a result of this action, DISCARD indicates that the received packet is to be cleared from the XDLP buffers, and INVALID indicates that the packet/state combination cannot occur. 							

Table 5-6. DTE effect on DCE reset states

Packet received from DTE	DCE reset states (see Note 2)		
	FLOW CONTROL READY <i>d1</i>	RESET REQUEST by DTE <i>d2</i>	DCE RESET REQUEST to DTE <i>d3</i>
Packet with a packet type identifier shorter than 1 byte	<i>A=ERROR</i> <i>S=d3</i> <i>D=38</i> (see Note 1)	<i>A=ERROR</i> <i>S=d3</i> <i>D=38</i> (see Note 1)	<i>A=DISCARD</i>
Packet with a packet type identifier which is undefined or not supported by DCE	<i>A=ERROR</i> <i>S=d3</i> <i>D=33</i> (see Note 1)	<i>A=ERROR</i> <i>S=d3</i> <i>D=33</i> (see Note 1)	<i>A=DISCARD</i>
RESTART REQUEST, RESTART CONFIRMATION, or REGISTRATION (if supported) packet with logical channel identifier unequal to 0	<i>A=ERROR</i> <i>S=d3</i> <i>D=41</i> (see Note 1)	<i>A=ERROR</i> <i>S=d3</i> <i>D=41</i> (see Note 1)	<i>A=DISCARD</i>
RESET REQUEST	<i>A=NORMAL</i> <i>S=d2</i> (forward)	<i>A=DISCARD</i>	<i>A=NORMAL</i> <i>S=d1</i> (do not forward)
RESET CONFIRMATION	<i>A=ERROR</i> <i>S=d3</i> <i>D=27</i> (see Note 1)	<i>A=ERROR</i> <i>S=d3</i> <i>D=28</i> (see Note 1)	<i>A=NORMAL</i> <i>S=d1</i> (do not forward)
INTERRUPT packet	See Table 5-7	<i>A=ERROR</i> <i>S=d3</i> <i>D=28</i> (see Note 1)	<i>A=DISCARD</i>
INTERRUPT CONFIRMATION packet	See Table 5-7	<i>A=ERROR</i> <i>S=d3</i> <i>D=28</i> (see Note 1)	<i>A=DISCARD</i>
DATA or flow control packet	See Table 5-8	<i>A=ERROR</i> <i>S=d3</i> <i>D=28</i> (see Note 1)	<i>A=DISCARD</i>
REJECT supported but not subscribed to	<i>A=ERROR</i> <i>S=d3</i> <i>D=37</i> (see Note 1)	<i>A=ERROR</i> <i>S=d3</i> <i>D=37</i> (see Note 1)	<i>A=DISCARD</i>
<i>NOTES:</i>			
1. The error procedure consists of performing the specified actions when entering the <i>d3</i> state (which includes forwarding a RESET REQUEST packet to the DTE) and sending a RESET REQUEST packet to the XDCE (via the formatting function).			
2. Table entries are defined as follows: A = action to be taken, S = the state to be entered, D = the diagnostic code to be used in packets generated as a result of this action, DISCARD indicates that the received packet is to be cleared for the XDLP buffers, and INVALID indicates that the packet/state combination cannot occur.			

Table 5-7. DTE effect on DCE interrupt transfer states

Packet received from DTE	DTE/DCE interrupt transfer states (see Note 2)	
	DTE INTERRUPT READY <i>i1</i>	DTE INTERRUPT SENT <i>i2</i>
INTERRUPT (see Note 1)	<i>A=NORMAL</i> <i>S=i2</i> (forward)	<i>A=ERROR</i> <i>S=d3</i> <i>D=44</i> (see Note 3)
Packet received from DTE	DTE/DCE interrupt transfer states (see Note 2)	
	DCE INTERRUPT READY <i>j1</i>	DCE INTERRUPT SENT <i>j2</i>
INTERRUPT CONFIRMATION (see Note 1)	<i>A=ERROR</i> <i>S=d3</i> <i>D=43</i> (see Note 3)	<i>A=NORMAL</i> <i>S=j1</i> (forward)
<p>NOTES:</p> <ol style="list-style-type: none"> 1. If the packet has a format error, then the error procedure applies (see Note 3). Interrupt packets with user data greater than 32 bytes should be treated as a format error. 2. Table entries are defined as follows: A = action to be taken, S = the state to be entered, D = the diagnostic code to be used in packets generated as a result of this action, DISCARD indicates that the received packet is to be cleared from the XDLP buffers, and INVALID indicates that the packet/state combination cannot occur. 3. The error procedure consists of performing the specified actions when entering the d3 state (which includes forwarding a RESET REQUEST packet to the DTE) and sending a RESET REQUEST packet to the XDCE (via the reformatting process). 		

Table 5-8. DTE effect on DCE flow control transfer states

Packet received from DTE	DCE flow control transfer states (see Notes 2 and 3)	
	DCE RECEIVE READY <i>f1</i>	DCE RECEIVE NOT READY <i>f2</i>
DATA packet with less than 4 bytes when using modulo 128 numbering	<i>A=ERROR</i> <i>S=d3</i> <i>D=38</i> (see Note 4)	<i>A=DISCARD</i>
DATA packet with invalid PR	<i>A=ERROR</i> <i>S=d3</i> <i>D=2</i> (see Note 4)	<i>A=ERROR</i> <i>S=d3</i> <i>D=2</i> (see Note 4)
DATA packet with valid PR but invalid PS or user data field with improper format	<i>A=ERROR</i> <i>S=d3</i> <i>D=1</i> (invalid PS) <i>D=39</i> (UD > max negotiated length) <i>D=82</i> (UD unaligned) (see Note 4)	<i>A=DISCARD</i> (process PR data)
DATA packet with valid PR with M-bit set to 1 when the user data field is partially full	<i>A=ERROR</i> <i>S=d3</i> <i>D=165</i> (see Note 4)	<i>A=DISCARD</i> (process PR data)
DATA packet with valid PR, PS and user data field format	<i>A=NORMAL</i> (forward)	<i>A=DISCARD</i> (process PR data)
Packet received from DTE	DCE flow control transfer states (see Notes 2 and 3)	
	DTE RECEIVE READY <i>g1</i>	DTE RECEIVE NOT READY <i>g2</i>
RR, RNR, or REJECT packet with less than 3 bytes when using modulo 128 numbering (see Note 1)	<i>A=DISCARD</i>	<i>A=DISCARD</i>
RR, RNR, or REJECT packet with an invalid PR	<i>A=ERROR</i> <i>S=d3</i> <i>D=2</i> (see Note 4)	<i>A=ERROR</i> <i>S=d3</i> <i>D=2</i> (see Note 4)
RR packet with a valid PR	<i>A=NORMAL</i>	<i>A=NORMAL</i> <i>S=g1</i>
RNR packet with a valid PR	<i>A=NORMAL</i> <i>S=g2</i>	<i>A=NORMAL</i>
REJECT packet with a valid PR	<i>A=NORMAL</i>	<i>A=NORMAL</i> <i>S=g1</i>
NOTES:		
1. The reject procedures are not required.		
2. The RR, RNR and REJECT procedures are a local DTE/DCE matter and the corresponding packets are not forwarded to the XDCE.		
3. Table entries are defined as follows: A = action to be taken, S = the state to be entered, D = the diagnostic code to be used in packets generated as a result of this action, DISCARD indicates that the received packet is to be cleared from the XDLP buffers, and INVALID indicates that the packet/state combination cannot occur.		
4. The error procedure consists of performing the specified actions when entering the d3 state (which includes forwarding a RESET REQUEST packet to the DTE) and sending a RESET REQUEST packet to the XDCE (via the reformatting process).		

Table 5-9. XDCE effect on DCE restart states

Packet received from XDCE	DCE restart states (see Note)		
	PACKET LEVEL READY <i>r1</i>	DTE RESTART REQUEST <i>r2</i>	DCE RESTART REQUEST <i>r3</i>
CALL REQUEST	See Table 5-10	Send CLEAR REQUEST to reformatting process with <i>D=244</i>	Send CLEAR REQUEST to reformatting process with <i>D=244</i>
CALL ACCEPT, CLEAR REQUEST, DATA, INTERRUPT, INTERRUPT CONFIRMATION, RESET REQUEST	See Table 5-10	<i>A=DISCARD</i>	<i>A=DISCARD</i>

Note.— Table entries are defined as follows: A = action to be taken, S = the state to be entered, D = the diagnostic code to be used in packets generated as a result of this action, DISCARD indicates that the received packet is to be cleared from the XDLP buffers, and INVALID indicates that the packet/state combination cannot occur.

Table 5-10. XDCE effect on DCE call setup and clearing states

Packet received from XDCE	DCE call setup and clearing states (see Note)						
	READY <i>p1</i>	DTE CALL REQUEST <i>p2</i>	DCE CALL REQUEST <i>p3</i>	DATA TRANSFER <i>p4</i>	CALL COLLISION <i>p5</i>	DTE CLEAR REQUEST <i>p6</i>	DCE CLEAR REQUEST to DTE <i>p7</i>
CALL REQUEST	<i>A=NORMAL</i> <i>S=p3</i> (forward)	INVALID	INVALID	INVALID	INVALID	INVALID	INVALID
CALL ACCEPT	<i>A=DISCARD</i>	<i>A=NORMAL</i> <i>S=p4</i> (forward)	INVALID	INVALID	INVALID	<i>A=DISCARD</i>	<i>A=DISCARD</i>
CLEAR REQUEST	<i>A=DISCARD</i>	<i>A=NORMAL</i> <i>S=p7</i> (forward)	<i>A=NORMAL</i> <i>S=p7</i> (forward)	<i>A=NORMAL</i> <i>S=p7</i> (forward)	INVALID	<i>A=DISCARD</i>	<i>A=DISCARD</i>
DATA, INTERRUPT, INTERRUPT CONFIRMATION, or RESET REQUEST	<i>A=DISCARD</i>	INVALID	INVALID	See Table 5-11	INVALID	<i>A=DISCARD</i>	<i>A=DISCARD</i>

Note.— Table entries are defined as follows: A = action to be taken, S = the state to be entered, D = the diagnostic code to be used in packets generated as a result of this action, DISCARD indicates that the received packet is to be cleared from the XDLP buffers, and INVALID indicates that the packet/state combination cannot occur.

Table 5-11. XDCE effect on DCE reset states

Packet received from XDCE	DCE reset states (see Note)		
	FLOW CONTROL READY <i>d1</i>	DTE RESET REQUEST <i>d2</i>	DCE RESET REQUEST TO DTE <i>d3</i>
RESET REQUEST	<i>A=NORMAL</i> <i>S=d3</i> (forward)	<i>A=NORMAL</i> <i>S=d1</i> (forward)	<i>A=DISCARD</i>
INTERRUPT	See Table 5-12	<i>A=DISCARD</i>	<i>A=DISCARD</i>
INTERRUPT CONFIRMATION	See Table 5-12	<i>A=DISCARD</i>	INVALID
DATA	<i>A=NORMAL</i> (forward)	<i>A=DISCARD</i>	<i>A=DISCARD</i>

Note.— Table entries are defined as follows: A = action to be taken, S = the state to be entered, D = the diagnostic code to be used in packets generated as a result of this action, DISCARD indicates that the received packet is to be cleared from the XDLP buffers, and INVALID indicates that the packet/state combination cannot occur.

Table 5-12. XDCE effect on DCE interrupt transfer states

Packet received from XDCE	DCE interrupt transfer states (see Note)	
	DTE INTERRUPT READY <i>i1</i>	DTE INTERRUPT SENT <i>i2</i>
INTERRUPT CONFIRMATION	INVALID	<i>A=NORMAL</i> <i>S=i1</i> (forward)

Packet received from XDCE	DCE interrupt transfer states (see Note)	
	DCE INTERRUPT READY <i>j1</i>	DCE INTERRUPT SENT <i>j2</i>
INTERRUPT	<i>A=NORMAL</i> <i>S=j2</i> (forward)	INVALID

Note.— Table entries are defined as follows: A = action to be taken, S = the state to be entered, D = the diagnostic code to be used in packets generated as a result of this action, DISCARD indicates that the received packet is to be cleared from the XDLP buffers, and INVALID indicates that the packet/state combination cannot occur.

Table 5-13. GDLP Mode S subnetwork timers

<i>Timer name</i>	<i>Timer label</i>	<i>Nominal value</i>	<i>Reference</i>
Active channel-GDLP	<i>T_x</i>	300 s	5.2.8.3.2
L-bit delivery-GDLP	<i>T_m</i>	120 s	5.2.7.4.3
Packet resequencing and S-bit delivery	<i>T_q</i>	60 s	5.2.6.9

Table 5-14. XDCE actions at state transition

<i>XDCE state</i>	<i>State definition</i>	<i>Action that shall be taken when entering the state</i>
<i>r1</i>	PACKET LEVEL READY	Return all SVCs to the <i>p1</i> state.
<i>p1</i>	READY	Release all resources assigned to the SVC. Break the correspondence between the ADCE/GDCE SVC and the DTE/DCE SVC (the DTE/DCE SVC may not yet be in a <i>p1</i> state).
<i>p2</i>	GDLP(ADLP) CALL REQUEST	Determine if sufficient resources exist to support request; if so allocate resources and forward Mode S CALL REQUEST packet to reformatting process; if not, enter ADCE(GDCE) CLEAR REQUEST to GDLP(ADLP) state (<i>p7</i>).
<i>p3</i>	ADCE(GDCE) CALL REQUEST	Determine if sufficient resources exist to support request; if so, allocate resources and forward Mode S CALL REQUEST packet to frame processing; if not, send Mode S CLEAR REQUEST to reformatting process and go to state <i>p1</i> . Do not forward the Mode S CALL REQUEST to the peer XDCE.
<i>p4</i>	DATA TRANSFER	No action.
<i>p6</i>	GDLP(ADLP) CLEAR REQUEST	Release all resources, send a Mode S CLEAR CONFIRMATION packet to the peer XDCE and enter the <i>p1</i> state.
<i>p7</i>	ADCE(GDCE) CLEAR REQUEST to GDLP(ADLP)	Forward Mode S CLEAR REQUEST packet to the peer XDCE via frame processing.
<i>d1</i>	FLOW CONTROL READY	No action.
<i>d2</i>	GDLP(ADLP) RESET REQUEST	Remove Mode S DATA packets transmitted to peer XDCE from window; discard any DATA packets that represent partially transmitted M-bit sequences and discard any Mode S INTERRUPT packets awaiting transfer to the peer XDCE; reset all flow control window counters to 0 (5.2.6.7.1). Send Mode S RESET CONFIRMATION packet to the peer XDCE. Return SVC to <i>d1</i> state. Forward Mode S RESET REQUEST packet to reformatting process.
<i>d3</i>	ADCE(GDCE) RESET REQUEST to GDLP(ADLP)	Remove Mode S DATA packets transmitted to peer XDCE from window; discard any DATA packets that represent partially transmitted M-bit sequences and discard any Mode S INTERRUPT packets awaiting transfer to the peer XDCE; reset all flow control window counters to 0 (5.2.6.7.1). Forward Mode S RESET REQUEST packet to peer XDCE via frame processing.
<i>i1</i>	GDLP(ADLP) INTERRUPT READY	No action.
<i>i2</i>	GDLP(ADLP) INTERRUPT SENT	Forward Mode S INTERRUPT packet received from peer XDCE to the reformatting process.
<i>j1</i>	ADCE(GDCE) INTERRUPT READY	No action.
<i>j2</i>	ADCE(GDCE) INTERRUPT SENT	Forward Mode S INTERRUPT packet received from the reformatting process.
<i>f1</i>	ADCE(GDCE) RECEIVE READY	No action.
<i>f2</i>	ADCE(GDCE) RECEIVE NOT READY	No action.
<i>g1</i>	GDLP(ADLP) RECEIVE READY	No action.
<i>g2</i>	GDLP(ADLP) RECEIVE NOT READY	No action.

Table 5-15. GDLP (ADLP) effect on ADCE (GDCE) packet layer ready states

Packet received from GDLP (ADLP) (see Note 2)	ADCE (GDCE) states (see Notes 1 and 3) PACKET LEVEL READY <i>r1</i>
CH=0 with no TC present (see Note 4) or CH=0 in a CALL ACCEPT by ADLP packet	<i>A=DISCARD</i>
Unassigned packet header	<i>A=DISCARD</i>
Call setup, call clearing, DATA, interrupt, flow control, or reset	See Table 5-16
<i>NOTES:</i>	
<ol style="list-style-type: none"> 1. <i>The XDCE state is not necessarily the same state as the DTE/DCE interface.</i> 2. <i>All packets from the peer XDLP have been checked for duplication before evaluation as represented by this table.</i> 3. <i>Table entries are defined as follows: A = action to be taken, S = the state to be entered, D = the diagnostic code to be used in packets generated as a result of this action, DISCARD indicates that the received packet is to be cleared from the XDLP buffers, and INVALID indicates that the packet/state combination cannot occur.</i> 4. <i>Where CH=0 and a valid TC is present in a CLEAR REQUEST by ADLP or GDLP packet or a CLEAR CONFIRMATION by ADLP or GDLP packet, it is handled as described in 5.2.5.1.2.3 and Table 5-16.</i> 	

Table 5-16. GDLP (ADLP) effect on ADCE (GDCE) call setup and clearing states

Packet received from GDLP (ADLP) (see Note 2)	ADCE (GDCE) call setup and clearing States (See Notes 1, 7 and 8)					
	READY <i>p1</i>	GDLP (ADLP) CALL REQUEST <i>p2</i>	ADCE (GDCE) CALL REQUEST <i>p3</i>	DATA TRANSFER <i>p4</i>	GDLP (ADLP) CLEAR REQUEST <i>p6</i>	ADCE (GDCE) CLEAR REQUEST to GDLP (ADLP) <i>p7</i>
Format error (see Note 3)	<i>A=ERROR</i> (see Note 10) <i>S=p7</i> <i>D=33</i> (see Note 9)	<i>A=ERROR</i> <i>S=p7</i> <i>D=33</i> (see Note 6)	<i>A=ERROR</i> <i>S=p7</i> <i>D=33</i> (see Notes 6 and 9)	See Table 5-17	<i>A=ERROR</i> <i>S=p7</i> <i>D=25</i> (see Note 6)	<i>A=DISCARD</i>
CALL REQUEST	<i>A=NORMAL</i> (5.2.6.3.1) <i>S=p2</i> (forward request to DCE)	<i>A=ERROR</i> <i>S=p7</i> <i>D=21</i> (see Note 6)	Not applicable (see Note 4)	Not applicable (see Note 4)	<i>A=ERROR</i> <i>S=p7</i> <i>D=25</i> (see Note 6)	<i>A=DISCARD</i>
CALL ACCEPT	<i>A=ERROR</i> <i>S=p7</i> <i>D=20</i> (see Note 10)	<i>A=ERROR</i> <i>S=p7</i> <i>D=21</i> (see Note 6)	<i>A=NORMAL</i> (5.2.6.3.1) <i>S=p4</i> (forward to DCE), or <i>A=ERROR</i> <i>S=p7</i> <i>D=42</i> (see Note 6)	<i>A=ERROR</i> <i>S=p7</i> <i>D=23</i> (see Note 6)	<i>A=ERROR</i> <i>S=p7</i> <i>D=25</i> (see Note 6)	<i>A=DISCARD</i>

Packet received from GDLP (ADLP) (see Note 2)	ADCE (GDCE) call setup and clearing States (See Notes 1, 7 and 8)					
	READY p1	GDLP (ADLP) CALL REQUEST p2	ADCE (GDCE) CALL REQUEST p3	DATA TRANSFER p4	GDLP (ADLP) CLEAR REQUEST p6	ADCE (GDCE) CLEAR REQUEST to GDLP (ADLP) p7
CLEAR REQUEST	<i>A=NORMAL</i> (5.2.6.3.3) <i>S=p6</i> (do not forward)	<i>A=NORMAL</i> (5.2.6.3.3) <i>S=p6</i> (forward to DCE)	<i>A=NORMAL</i> (5.2.6.3.3) <i>S=p6</i> (forward to DCE)	<i>A=NORMAL</i> (5.2.6.3.3) <i>S=p6</i> (forward to DCE)	<i>A=DISCARD</i>	<i>A=NORMAL</i> (5.2.6.3.3) <i>S=p1</i> (do not forward)
CLEAR CONFIRMATION	<i>A=ERROR</i> <i>S=p7</i> <i>D=20</i> (see Note 10)	<i>A=ERROR</i> <i>S=p7</i> <i>D=21</i> (see Note 6)	<i>A=ERROR</i> <i>S=p7</i> <i>D=22</i> (see Note 6)	<i>A=ERROR</i> <i>S=p7</i> <i>D=23</i> (see Note 6)	<i>A=ERROR</i> <i>S=p7</i> <i>D=25</i> (see Note 6)	<i>A=NORMAL</i> (5.2.6.3.3) <i>S=p1</i> (do not forward)
DATA, interrupt, flow control or reset packets	<i>A=ERROR</i> <i>S=p7</i> <i>D=20</i> (see Note 10)	<i>A=ERROR</i> <i>S=p7</i> <i>D=21</i> (see Notes 6 and 9)	<i>A=ERROR</i> <i>S=p7</i> <i>D=22</i> (see Notes 5 and 6)	See Table 5-17	<i>A=ERROR</i> <i>S=p7</i> <i>D=25</i> (see Note 6)	<i>A=DISCARD</i>

NOTES:

1. The XDCE is not necessarily in the same state as the DTE/DCE interface.
2. All packets from the peer XDLP have been checked for duplication before evaluation as represented by this table.
3. A format error may result from an S-bit sequence having a first or intermediate packet shorter than the maximum length, or else from an invalid LV field in a CALL REQUEST, CALL ACCEPT, CLEAR REQUEST or INTERRUPT packet. There are no other detectable Mode S format errors.
4. The ADCE assigns all channel numbers used between the ADLP and GDLP, hence call collisions are not possible. When a CALL REQUEST by GDLP packet is received bearing a temporary channel number associated with an SVC in the p4 state, the association of the temporary to permanent channel number is broken (5.2.5.1.2.3).
5. Not applicable to the GDLP.
6. The error procedure consists of performing the actions specified when entering the p7 state (including sending a CLEAR REQUEST packet to the peer XDLP) and additionally sending a CLEAR REQUEST packet to the DCE (via the reformatting process).
7. Table entries are defined as follows: A = action to be taken, S = the state to be entered, D = the diagnostic code to be used in packets generated as a result of this action, DISCARD indicates that the received packet is to be cleared from the XDLP buffers, and INVALID indicates that the packet/state combination cannot occur.
8. The number in parentheses below an "A = NORMAL" table entry is the paragraph number in this document that defines the actions to be taken to perform normal processing on the received packet. If no paragraph number is referenced, the normal processing is defined in the table entry.
9. An error condition is declared and transfer to the p7 state is possible only if the ground DTE address is known unambiguously. Otherwise the action is to discard the packet.
10. The error procedure consists of performing the action when entering the p7 state (including sending a CLEAR REQUEST packet to the XDLP) but without sending a CLEAR REQUEST packet to the local DCE.

Table 5-17. GDLP (ADLP) effect on ADCE (GDCE) reset states

Packet received from GDLP (ADLP) (see Note 2)	ADCE (GDCE) reset states (see Notes 1, 4 and 5)		
	FLOW CONTROL READY <i>d1</i>	GDLP (ADLP) RESET REQUEST <i>d2</i>	ADCE (GDCE) RESET REQUEST to GDLP (ADLP) <i>d3</i>
RESET REQUEST	<i>A=NORMAL</i> (5.2.6.7) <i>S=d2</i> (forward to DCE)	<i>A=DISCARD</i>	<i>A=NORMAL</i> (5.2.6.7) <i>S=d1</i> (do not forward)
RESET CONFIRMATION	<i>A=ERROR</i> <i>S=d3</i> <i>D=27</i> (see Note 3)	<i>A=ERROR</i> <i>S=d3</i> <i>D=28</i> (see Note 3)	<i>A=NORMAL</i> (5.2.6.7) <i>S=d1</i> (do not forward)
INTERRUPT	See Table 5-18	<i>A=ERROR</i> <i>S=d3</i> <i>D=28</i> (see Note 3)	<i>A=DISCARD</i>
INTERRUPT CONFIRMATION	See Table 5-18	<i>A=ERROR</i> <i>S=d3</i> <i>D=28</i> (see Note 3)	<i>A=DISCARD</i>
DATA or flow control packet	See Table 5-19	<i>A=ERROR</i> <i>S=d3</i> <i>D=28</i> (see Note 3)	<i>A=DISCARD</i>
Format error (see Note 6)	<i>A=ERROR</i> <i>S=d3</i> <i>D=33</i> (see Note 3)	<i>A=ERROR</i> <i>S=d3</i> <i>D=33</i> (see Note 3)	<i>A=DISCARD</i>

NOTES:

1. The XDCE is not necessarily in the same state as the DTE/DCE interface.
2. All packets from the peer XDLP have been checked for duplication before evaluation as represented by this table.
3. The error procedure consists of performing the specified actions when entering the *d3* state (which includes forwarding a RESET REQUEST packet to the peer XDLP) and sending a RESET REQUEST packet to the DCE (via the formatting function).
4. Table entries are defined as follows: A = action to be taken, S = the state to be entered, D = the diagnostic code to be used in packets generated as a result of this action, DISCARD indicates that the received packet is to be cleared for the XDLP buffers, and INVALID indicates that the packet/state combination cannot occur.
5. The number in parentheses below an "A = NORMAL" table entry is the paragraph number in this document that defines the actions to be taken to perform normal processing on the received packet. If no paragraph number is referenced, the normal processing is defined in the table entry.
6. A format error may result from an S-bit sequence having a first or intermediate packet shorter than the maximum length, or else from an invalid LV field in a CALL REQUEST, CALL ACCEPT, CLEAR REQUEST, or INTERRUPT packet. There are no other detectable Mode S format errors.

Table 5-18. GDLP (ADLP) effect on ADCE (GDCE) interrupt transfer states

Packet received from GDLP (ADLP) (see Note 2)	ADCE/GDCE interrupt transfer states (see Notes 1, 3 and 4)	
	GDLP (ADLP) INTERRUPT READY <i>i1</i>	GDLP (ADLP) INTERRUPT SENT <i>i2</i>
INTERRUPT (see Note 6)	<i>A=NORMAL</i> (5.2.6.4.5) <i>S=i2</i> (forward to DCE)	<i>A=ERROR</i> <i>S=d3</i> <i>D=44</i> (see Note 5)
Packet received from GDLP (ADLP) (see Note 2)	ADCE (GDCE) interrupt transfer states (see Notes 1, 3 and 4)	
	ADCE (GDCE) INTERRUPT READY <i>j1</i>	ADCE (GDCE) INTERRUPT SENT <i>j2</i>
INTERRUPT CONFIRMATION	<i>A=ERROR</i> <i>S=d3</i> <i>D=43</i> (see Note 5)	<i>A=NORMAL</i> (5.2.6.4.5) <i>S=j1</i> (forward confirmation to DCE)
NOTES:		
1. The XDCE is not necessarily in the same state as the DTE/DCE interface.		
2. All packets from the peer XDLP have been checked for duplication before evaluation as represented by this table.		
3. Table entries are defined as follows: A = action to be taken, S = the state to be entered, D = the diagnostic code to be used in packets generated as a result of this action, DISCARD indicates that the received packet is to be cleared for the XDLP buffers, and INVALID indicates that the packet/state combination cannot occur.		
4. The number in parentheses below an "A = NORMAL" table entry is the paragraph number in this document that defines the actions to be taken to perform normal processing on the received packet. If no paragraph number is referenced, the normal processing is defined in the table entry.		
5. The error procedure consists of performing the specified actions when entering the d3 state (which includes forwarding a RESET REQUEST packet to the peer XDLP) and sending a RESET REQUEST packet to the DCE (via the reformatting process).		
6. User data length for INTERRUPT packets greater than 32 bytes, or an out of sequence INTERRUPT packet, are considered as errors.		

Table 5-19. GDLP (ADLP) effect on ADCE (GDCE) flow control transfer states

Packet received from GDLP (ADLP) (see Note 2)	ADCE (GDCE) flow control transfer states (see Notes 1, 6 and 7)	
	ADCE (GDCE) RECEIVE READY <i>f1</i>	ADCE (GDCE) RECEIVE NOT READY <i>f2</i>
DATA packet with invalid PR (see Note 3)	<i>A=ERROR</i> <i>S=d3</i> <i>D=2</i> (see Note 8)	<i>A=ERROR</i> <i>S=d3</i> <i>D=2</i> (see Note 8)
DATA packet with valid PR, invalid PS or LV subfield (see Notes 4 and 5)	<i>A=DISCARD</i> , but process the PR value and send REJECT packet containing the expected PS value (see Note 5)	<i>A=DISCARD</i> , but process the PR value and send REJECT packet containing the expected PS value when busy condition ends

DATA packet with valid PR, PS and LV subfield	<i>A=NORMAL</i> (5.2.6.4.4) (forward)	<i>A=PROCESS</i> , if possible; or <i>A=DISCARD</i> , but process the PR value and send REJECT containing the expected PS value when busy condition ends
	ADCE (GDCE) flow control transfer states (see Notes 1, 6 and 7)	
Packet received from GDLP (ADLP) (see Note 2)	GDLP (ADLP) RECEIVE READY g1	GDLP (ADLP) RECEIVE NOT READY g2
RR, RNR, REJECT packet with invalid PR (see Note 3)	<i>A=ERROR</i> <i>S=d3</i> <i>D=2</i> (see Note 8)	<i>A=ERROR</i> <i>S=d3</i> <i>D=2</i> (see Note 8)
RR with valid PR field (see Note 9)	<i>A=NORMAL</i> (5.2.6.5)	<i>A=NORMAL</i> (5.2.6.6) <i>S=g1</i>
RNR with valid PR value (see Note 9)	<i>A=NORMAL</i> (5.2.6.5) <i>S=g2</i>	<i>A=NORMAL</i> (5.2.6.6)
REJECT with valid PR (see Note 9)	<i>A=NORMAL</i> (5.2.6.5)	<i>A=NORMAL</i> (5.2.6.6) <i>S=g1</i>
<i>NOTES:</i>		
<ol style="list-style-type: none"> 1. The XDCE is not necessarily in the same state as the DTE/DCE interface. 2. All packets from the peer XDLP have been checked for duplication before evaluation as represented by this table. 3. An invalid PR value is one which is less than the PR value (modulo 16) of the last packet sent by the peer XDLP, or greater than the PS value of the next data packet to be transmitted by the XDLP. 4. An invalid PS value is one which is different from the next expected value for PS. 5. An invalid LV subfield is one which represents a value that is too large for the size of the segment received. In the event of an LV field error which gives rise to a loss of confidence in the correctness of the other fields in the packet, the packet is discarded without any further action. 6. Table entries are defined as follows: A = action to be taken, S = the state to be entered, D = the diagnostic code to be used in packets generated as a result of this action, DISCARD indicates that the received packet is to be cleared from the XDLP buffers, and INVALID indicates that the packet/state combination cannot occur. 7. The number in parentheses below an "A = NORMAL" table entry is the paragraph number in this document that defines the actions to be taken to perform normal processing on the received packet. If no paragraph number is referenced, the normal processing is defined in the table entry. 8. The error procedure consists of performing the specified actions when entering the d3 state (which includes forwarding a RESET REQUEST packet to the peer XDLP) and sending a RESET REQUEST packet to the DCE (via the reformatting process). 9. RR, RNR, and REJECT packets have no end-to-end significance and are not forwarded to the DCE. 10. The receipt of a packet smaller than the maximum packet size with M-bit = 1 will cause a reset to be generated and the remainder of the sequence will be discarded. 		

Table 5-20. DCE effect on ADCE (GDCE) call setup and clearing states

Packet received from DCE (see Notes 2 and 4)	ADCE (GDCE) call setup and clearing states (see Notes 1, 7 and 8)					
	READY <i>p1</i>	GDLP (ADLP) CALL REQUEST <i>p2</i>	ADCE (GDCE) CALL REQUEST <i>p3</i>	DATA TRANSFER <i>p4</i>	GDLP (ADLP) CLEAR REQUEST <i>p6</i>	ADCE (GDCE) to GDLP (ADLP) CLEAR REQUEST <i>p7</i>
CALL REQUEST (see Note 6)	<i>A=NORMAL</i> (5.2.6.3.1) <i>S=p3</i> (forward)	INVALID (see Note 5)	INVALID (see Note 3)	INVALID (see Note 3)	INVALID (see Note 3)	INVALID (see Note 3)
CALL ACCEPT (see Note 4)	<i>A=DISCARD</i>	<i>A=NORMAL</i> <i>S=p4</i> (forward)	INVALID (see Note 3)	INVALID (see Note 3)	<i>A=DISCARD</i>	<i>A=DISCARD</i>
CLEAR REQUEST (see Note 4)	<i>A=DISCARD</i>	<i>A=NORMAL</i> (5.2.6.3.3) <i>S=p7</i> (forward)	<i>A=NORMAL</i> (5.2.6.3.3) <i>S=p7</i> (forward)	<i>A=NORMAL</i> (5.2.6.3.3) <i>S=p7</i> (forward)	<i>A=DISCARD</i>	<i>A=DISCARD</i>
DATA, INTERRUPT or RESET packets (see Note 4)	<i>A=DISCARD</i>	INVALID (see Note 3)	INVALID (see Note 3)	See Table 5-21	<i>A=DISCARD</i>	<i>A=DISCARD</i>

NOTES:

1. The XDCE is not necessarily in the same state as the DTE/DCE interface.
2. This is the DTE packet received via the DCE after all DTE/DCE processing has occurred. Procedures local to the DTE/DCE interface (such as RR, RNR, and REJECT if in effect), do not affect the XDCE directly. All error procedures as documented in ISO 8208 have been performed. Hence certain packets are rejected by the interface and are not represented in this table.
3. The DCE in its protocol operation with the DTE will detect this error condition, hence the erroneous packet can be said never to “reach” the XDCE; see also Note 2.
4. The channel number for the DTE/DCE need not be the same channel number used for the ADCE/GDCE; a packet from the DTE which contains a channel number is associated with an air/ground channel by means of a previously established cross-reference table. If none exists then the DTE/DCE channel by definition references an air/ground channel in the *p1* state.
5. The ADCE assigns all channel numbers used between the ADLP and GDLP; hence call collisions (denoted *p5* ISO 8208) are not possible; see also Note 4.
6. A CALL REQUEST from the DTE can never be associated with an XDCE channel number which is not in the *p1* state.
7. Table entries are defined as follows: A = action to be taken, S = the state to be entered, D = the diagnostic code to be used in packets generated as a result of this action, DISCARD indicates that the received packet is to be cleared from the XDLP buffers, and INVALID indicates that the packet/state combination cannot occur.
8. The number in parentheses below an “A = NORMAL” table entry is the paragraph number in this document that defines the actions to be taken to perform normal processing on the received packet. If no paragraph number is referenced, the normal processing is defined in the table entry.

Table 5-21. DCE effect on ADCE (GDCE) reset states

Packet received from DCE	ADCE (GDCE) reset states (see Notes 1, 4 and 5)		
	FLOW CONTROL READY <i>d1</i>	GDLP (ADLP) RESET REQUEST <i>d2</i>	ADCE (GDCE) RESET REQUEST to GDLP (ADLP) <i>d3</i>
RESET REQUEST	<i>A=NORMAL</i> (5.2.6.7) <i>S=d3</i> (forward)	<i>A=NORMAL</i> (5.2.6.7) <i>S=d1</i> (forward)	<i>A=DISCARD</i>
RESET CONFIRMATION	INVALID (see Note 3)	INVALID (see Note 3)	INVALID (see Note 3)
INTERRUPT	See Table 5-22	<i>A=DISCARD</i>	Hold interrupt until Mode S reset complete
INTERRUPT CONFIRMATION	See Table 5-22	<i>A=DISCARD</i>	INVALID (see Note 3)
DATA (see Note 2)	<i>A=NORMAL</i> (5.2.6.4) (forward)	<i>A=DISCARD</i>	Hold data until Mode S reset complete
NOTES:			
1. The XDCE is not necessarily in the same state as the DTE/DCE interface.			
2. This is the DTE packet received via the DCE after all DTE/DCE processing has occurred. Procedures local to the DTE/DCE interface (such as RR, RNR, and REJECT if in effect), do not affect the XDCE directly. All error procedures as documented in ISO 8208 have been performed. Hence certain packets are rejected by the interface and are not represented in this table.			
3. The DCE in its protocol operation with the DTE will detect this error condition, hence the erroneous packet can be said never to “reach” the XDCE; see also Note 2.			
4. Table entries are defined as follows: A = action to be taken, S = the state to be entered, D = the diagnostic code to be used in packets generated as a result of this action, DISCARD indicates that the received packet is to be cleared from the XDLP buffers, and INVALID indicates that the packet/state combination cannot occur.			
5. The number in parentheses below an “A = NORMAL” table entry is the paragraph number in this document that defines the actions to be taken to perform normal processing on the received packet. If no paragraph number is referenced, the normal processing is defined in the table entry.			

Table 5-22. DCE effect on ADCE (GDCE) interrupt transfer states

Packet received from DCE (see Note 2)	ADCE (GDCE) interrupt transfer state (see Notes 1, 4 and 5)	
	GDLP (ADLP) INTERRUPT READY <i>i</i> 1	GDLP (ADLP) INTERRUPT SENT <i>i</i> 2
INTERRUPT CONFIRMATION	INVALID (See Note 3)	<i>A</i> =NORMAL (5.2.6.4.5) <i>S</i> = <i>i</i> 1 (forward)
Packet received from DCE (see Note 2)	ADCE (GDCE) interrupt transfer states (see Notes 1, 4 and 5)	
	ADCE (GDCE) INTERRUPT READY <i>j</i> 1	ADCE (GDCE) INTERRUPT SENT <i>j</i> 2
INTERRUPT	<i>A</i> =NORMAL (5.2.6.4.5) <i>S</i> = <i>j</i> 2 (forward)	INVALID (see Note 3)
<i>NOTES:</i>		
<ol style="list-style-type: none"> 1. The XDCE is not necessarily in the same state as the DTE/DCE interface. 2. This is the DTE packet received via the DCE after all DTE/DCE processing has occurred. Procedures local to the DTE/DCE interface (such as RR, RNR, and REJECT if in effect), do not affect the XDCE directly. All error procedures as documented in ISO 8208 have been performed. Hence certain packets are rejected by the interface and are not represented in this state. 3. The DCE in its protocol operation with the DTE will detect this error condition, hence the erroneous packet can be said never to “reach” the XDCE; see also Note 2. 4. Table entries are defined as follows: A = action to be taken, S = the state to be entered, D = the diagnostic code to be used in packets generated as a result of this action, DISCARD indicates that the received packet is to be cleared from the XDLP buffers, and INVALID indicates that the packet/state combination cannot occur. 5. The number in parentheses below an “A = NORMAL” table entry is the paragraph number in this document that defines the actions to be taken to perform normal processing on the received packet. If no paragraph number is referenced, the normal processing is defined in the table entry. 		

Table 5-23. Broadcast identifier number assignments

<i>Uplink broadcast identifier</i>	<i>Assignment</i>
00 ₁₆	Not valid
01 ₁₆	Reserved (differential GNSS correction)
30 ₁₆	Not valid
31 ₁₆	Reserved for ACAS (RA broadcast)
32 ₁₆	Reserved for ACAS (ACAS broadcast)
Others	Unassigned
<i>Downlink broadcast identifier</i>	<i>Assignment</i>
00 ₁₆	Not valid
02 ₁₆	Reserved (traffic information service)
10 ₁₆	Data link capability report
20 ₁₆	Aircraft identification
FE ₁₆	Update request
FF ₁₆	Search request
Others	Unassigned

Table 5-24. Register number assignments

<i>Transponder register No.</i>	<i>Assignment</i>
00 ₁₆	Not valid
01 ₁₆	Unassigned
02 ₁₆	Linked Comm-B, segment 2
03 ₁₆	Linked Comm-B, segment 3
04 ₁₆	Linked Comm-B, segment 4
05 ₁₆	Extended squitter airborne position
06 ₁₆	Extended squitter surface position
07 ₁₆	Extended squitter status
08 ₁₆	Extended squitter identification and type
09 ₁₆	Extended squitter airborne velocity
0A ₁₆	Extended squitter event-driven information
0B ₁₆	Air/air information 1 (aircraft state)
0C ₁₆	Air/air information 2 (aircraft intent)
0D ₁₆ -0E ₁₆	Reserved for air/air state information
0F ₁₆	Reserved for ACAS
10 ₁₆	Data link capability report
11 ₁₆ -16 ₁₆	Reserved for extension to data link capability reports
17 ₁₆	Common usage GICB capability report
18 ₁₆ -1F ₁₆	Mode S specific services capability reports
20 ₁₆	Aircraft identification
21 ₁₆	Aircraft and airline registration markings
22 ₁₆	Antenna positions
23 ₁₆	Reserved for antenna position
24 ₁₆	Reserved for aircraft parameters
25 ₁₆	Aircraft type
26 ₁₆ -2F ₁₆	Unassigned
30 ₁₆	ACAS active resolution advisory
31 ₁₆ -3F ₁₆	Unassigned
40 ₁₆	Selected vertical intention
41 ₁₆	Next waypoint identifier
42 ₁₆	Next waypoint position
43 ₁₆	Next waypoint information
44 ₁₆	Meteorological routine air report

<i>Transponder register No.</i>	<i>Assignment</i>
45 ₁₆	Meteorological hazard report
46 ₁₆	Reserved for flight management system Mode 1
47 ₁₆	Reserved for flight management system Mode 2
48 ₁₆	VHF channel report
49 ₁₆ -4F ₁₆	Unassigned
50 ₁₆	Track and turn report
51 ₁₆	Position report coarse
52 ₁₆	Position report fine
53 ₁₆	Air-referenced state vector
54 ₁₆	Waypoint 1
55 ₁₆	Waypoint 2
56 ₁₆	Waypoint 3
57 ₁₆ -5E ₁₆	Unassigned
5F ₁₆	Quasi-static parameter monitoring
60 ₁₆	Heading and speed report
61 ₁₆	Extended squitter emergency/priority status
62 ₁₆	Reserved for target state and status information
63 ₁₆	Reserved for extended squitter
64 ₁₆	Reserved for extended squitter
65 ₁₆	Aircraft operational status
66 ₁₆ -6F ₁₆	Reserved for extended squitter
70 ₁₆ -75 ₁₆	Reserved for future aircraft downlink parameters
76 ₁₆ -E0 ₁₆	Unassigned
E1 ₁₆ -E2 ₁₆	Reserved for Mode S BITE
E3 ₁₆	Transponder type/part number
E4 ₁₆	Transponder software revision number
E5 ₁₆	ACAS unit part number
E6 ₁₆	ACAS unit software revision number
E7 ₁₆ -F0 ₁₆	Unassigned
F1 ₁₆	Military applications
F2 ₁₆	Military applications
F3 ₁₆ -FF ₁₆	Unassigned

Note.— In the context of Table 5-24, the term “aircraft” can be understood as “transponder carrying aircraft”, “pseudo-aircraft (e.g. an obstacle)” or “vehicle”.

Table 5-25. MSP channel number assignments

<i>Uplink channel number</i>	<i>Assignment</i>
0	Not valid
1	Reserved (specific services management)
2	Reserved (traffic information service)
3	Reserved (ground-to-air alert)
4	Reserved (ground derived position)
5	ACAS sensitivity level control
6	Reserved (ground-to-air service request)
7	Reserved (air-to-ground service response)
8–63	Unassigned
<i>Downlink channel number</i>	<i>Assignment</i>
0	Not valid
1	Reserved (specific services management)
2	Unassigned
3	Reserved (data flash)
4	Reserved (position request)
5	Unassigned
6	Reserved (ground-to-air service response)
7	Reserved (air-to-ground service request)
8–63	Unassigned

FIGURES FOR CHAPTER 5

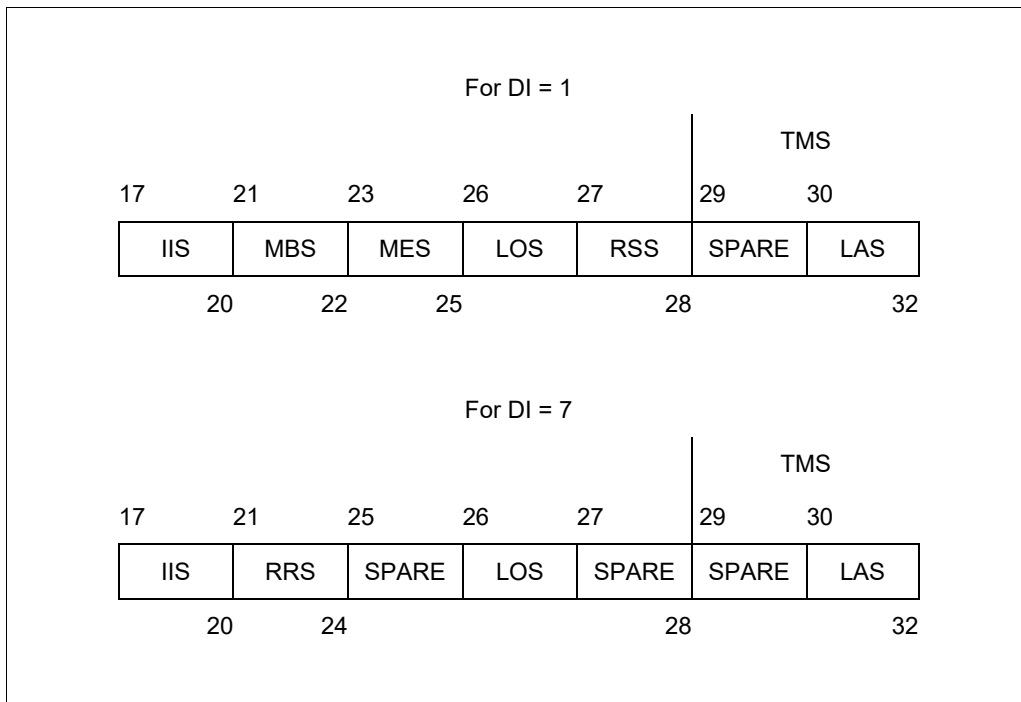

Figure 5-1. The SD field structure

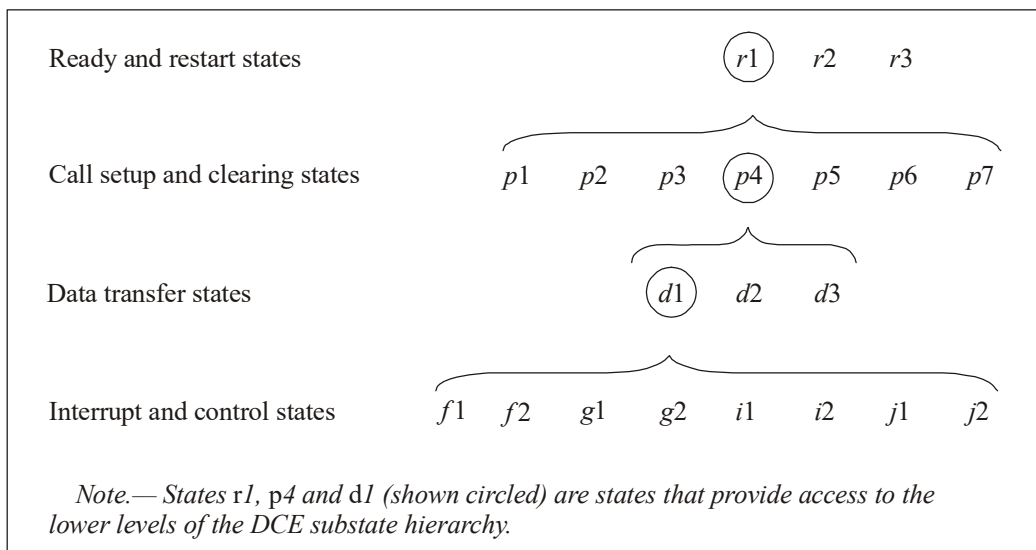

Figure 5-2. DCE substate hierarchy

1	2	3	4 5	6 7	8
DP=0	MP=1	SP=1	ST=0	FILL2	
P	FILL	SN			
CH			LAM		
AG					
S	FS	F	LV		
UD					

Figure 5-3. CALL REQUEST by ADLP packet

1	2	3	4 5	6 7	8
DP=0	MP=1	SP=1	ST=0	FILL	
P	FILL	SN			
FILL		TC	AM		
AG					
S	FS	F	LV		
UD					

Figure 5-4. CALL REQUEST by GDLP packet

1	2	3	4 5	6 7	8
DP=0	MP=1	SP=1	ST=1	FILL2	
TC		SN			
CH			AM		
AG					
S	FILL	F	LV		
UD					

Figure 5-5. CALL ACCEPT by ADLP packet

1	2	3	4 5	6 7	8
DP=0	MP=1	SP=1	ST=1	FILL	
FILL		SN			
CH			AM		
AG					
S	FILL		F	LV	
UD					

Figure 5-6. CALL ACCEPT by GDLP packet

1	2	3	4 5	6 7	8
DP=0	MP=1	SP=1	ST=2	FILL2	
TC		SN			
CH			AM		
AG					
CC					
DC					
S	FILL		F	LV	
UD					

Figure 5-7. CLEAR REQUEST by ADLP packet

1	2	3	4	5	6	7	8
DP=0		MP=1		SP=1		ST=2	FILL
TC			SN				
CH				AM			
AG							
CC							
DC							
S		FILL		F	LV		
UD							

Figure 5-8. CLEAR REQUEST by GDLP packet

1	2	3	4	5	6	7	8
DP=0		MP=1		SP=1		ST=3	FILL2
TC			SN				
CH				AM			
AG							

Figure 5-9. CLEAR CONFIRMATION by ADLP packet

1	2	3	4	5	6	7	8
DP=0		MP=1		SP=1		ST=3	FILL
TC			SN				
CH				AM			
AG							

Figure 5-10. CLEAR CONFIRMATION by GDLP packet

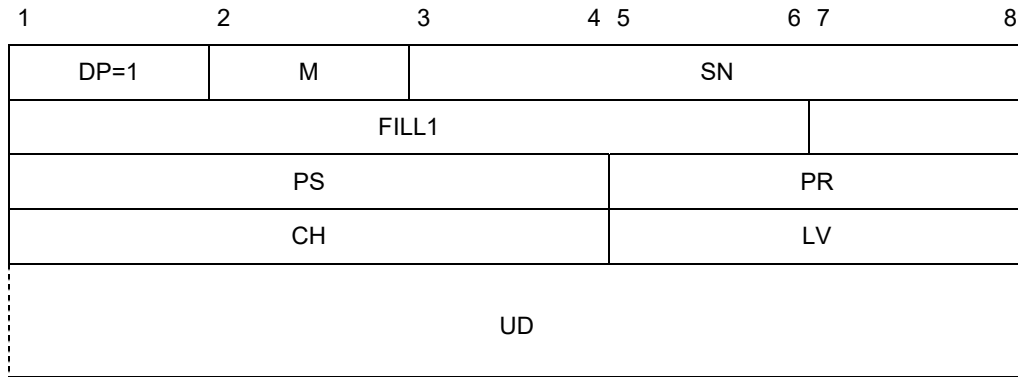

Figure 5-11. DATA packet

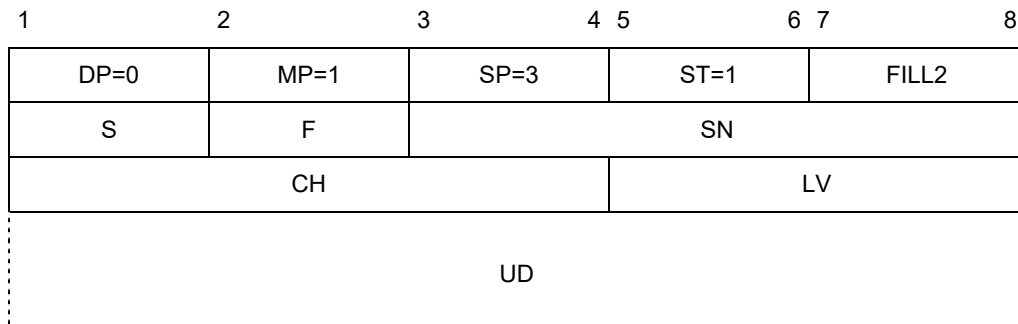

Figure 5-12. INTERRUPT packet

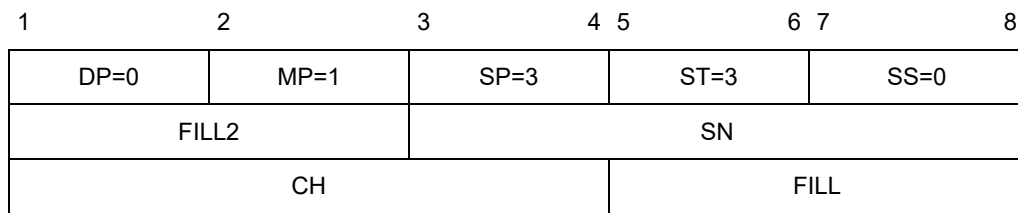

Figure 5-13. INTERRUPT CONFIRMATION packet

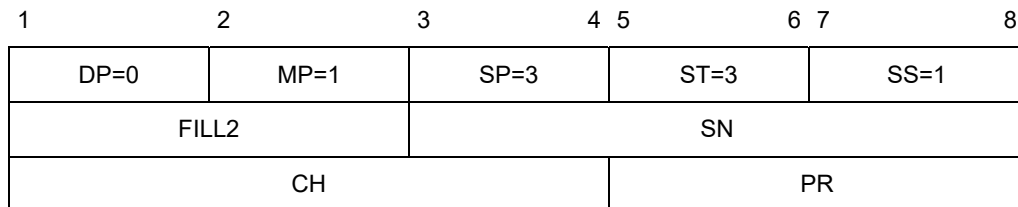

Figure 5-14. REJECT packet

1	2	3	4 5	6 7	8
DP=0	MP=1	SP=2	ST=0	FILL2	
FILL		SN			
CH			PR		

Figure 5-15. RECEIVE READY packet

1	2	3	4 5	6 7	8
DP=0	MP=1	SP=2	ST=1	FILL2	
FILL		SN			
CH			PR		

Figure 5-16. RECEIVE NOT READY packet

1	2	3	4 5	6 7	8
DP=0	MP=1	SP=2	ST=2	FILL2	
FILL		SN			
CH			FILL		
RC					
DC					

Figure 5-17. RESET REQUEST packet

1	2	3	4 5	6 7	8
DP=0	MP=1	SP=2	ST=3	FILL2	
FILL		SN			
CH			FILL		

Figure 5-18. RESET CONFIRMATION packet

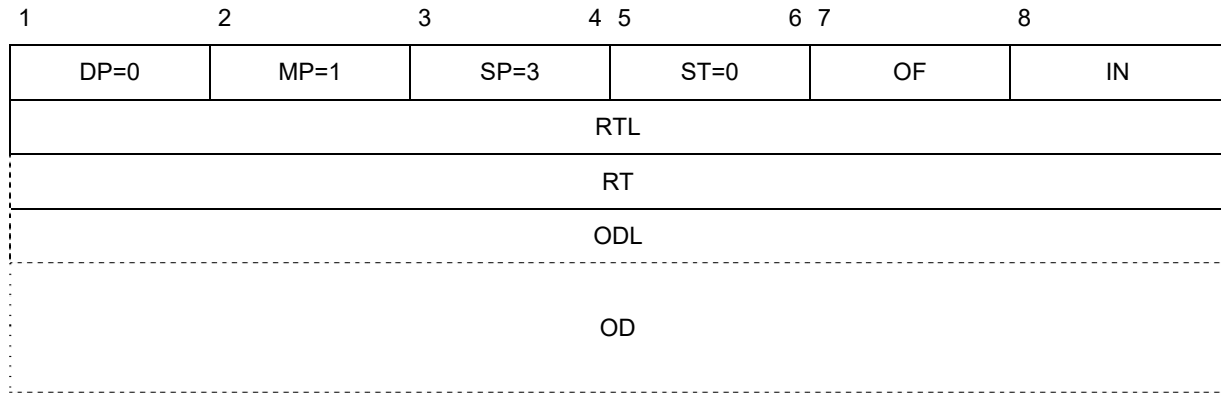

Figure 5-19. ROUTE packet

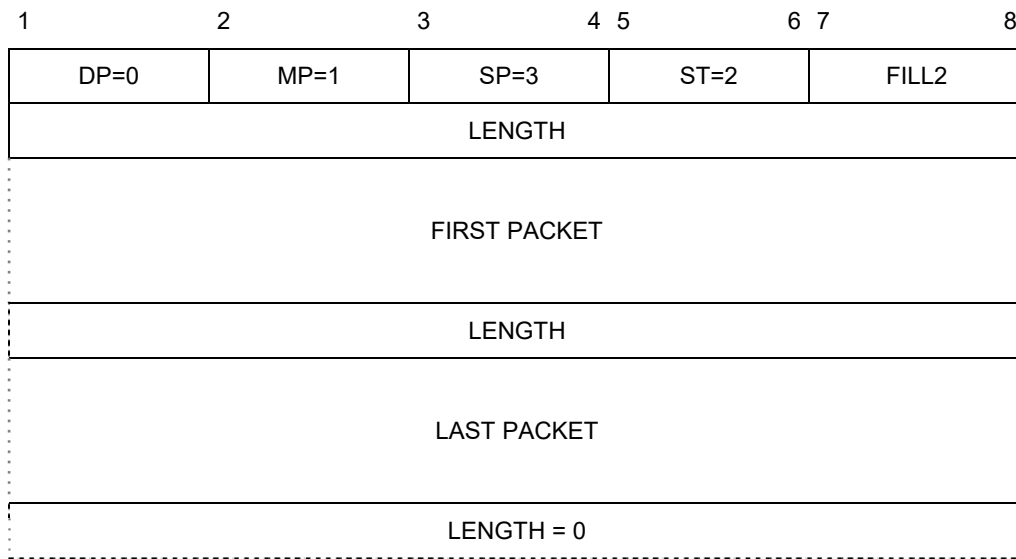

Figure 5-20. MULTIPLEX packet

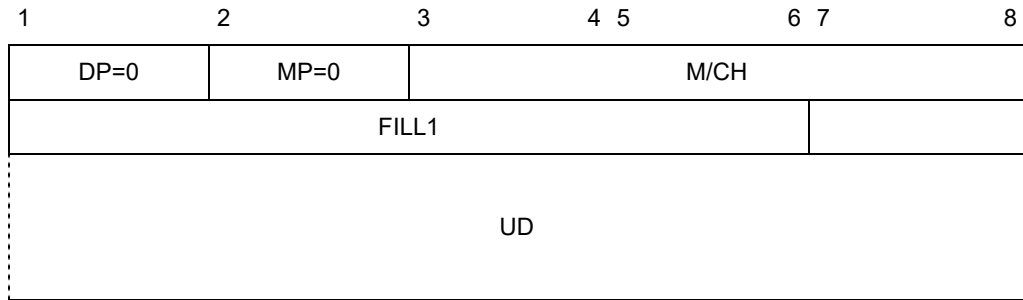

Figure 5-21. SHORT FORM MSP packet

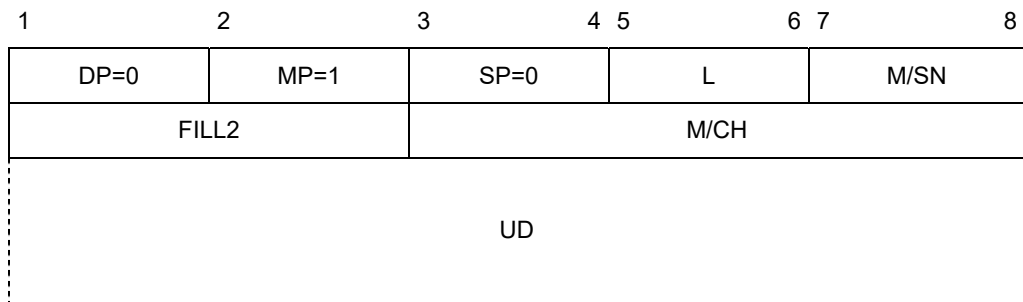
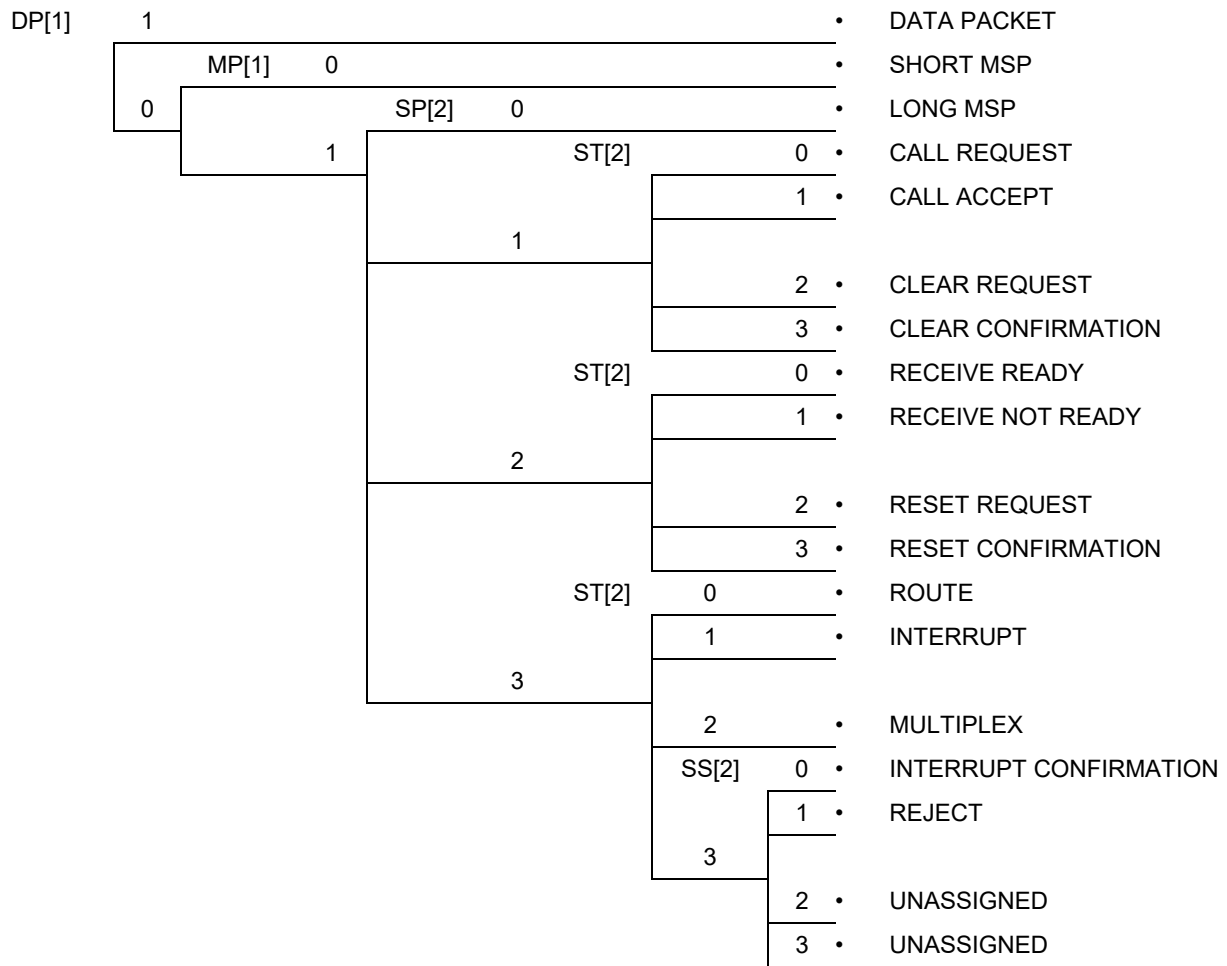

Figure 5-22. LONG FORM MSP packet



LEGEND:

DP = DATA packet type

MP = MSP packet type

SP = SUPERVISORY packet

ST = SUPERVISORY type

SS = SUPERVISORY subset

Figure 5-23. Control fields used in MODE S packets

CHAPTER 6. VHF AIR-GROUND DIGITAL LINK (VDL)

6.1 DEFINITIONS AND SYSTEM CAPABILITIES

Note 1.— The very high frequency (VHF) digital link (VDL) Mode 2 and the VDL Mode 4 provide data service capabilities. The VDL Mode 3 provides both voice and data service capabilities. The data capability is a constituent mobile subnetwork of the aeronautical telecommunication network (ATN). In addition, the VDL may provide non-ATN functions. Standards and Recommended Practices (SARPs) for the VDL are defined and referenced below.

Note 2.— Additional information on VDL is contained in the Manuals on VHF VDL Mode 2, VDL Mode 3 and VDL Mode 4 Technical Specifications (Docs 9776, 9805 and 9816).

Note 3.— Sections 6.1.2 to 6.8.2 contain Standards and Recommended Practices for VDL Modes 2 and 3. Section 6.9 contains Standards and Recommended Practices for VDL Mode 4.

6.1.1 Definitions

Automatic dependent surveillance-broadcast (ADS-B). A means by which aircraft, aerodrome vehicles and other objects can automatically transmit and/or receive data such as identification, position and additional data, as appropriate, in a broadcast mode via a data link.

Broadcast. A transmission of information relating to air navigation that is not addressed to a specific station or stations.

Burst. A time-defined, contiguous set of one or more related signal units which may convey user information and protocols, signalling, and any necessary preamble.

Current slot. The slot in which a received transmission begins.

Data circuit-terminating equipment (DCE). A DCE is a network provider equipment used to facilitate communications between DTEs.

Data link entity (DLE). A protocol state machine capable of setting up and managing a single data link connection.

Data link service (DLS) sublayer. The sublayer that resides above the MAC sublayer. For VDL Mode 4, the DLS sublayer resides above the VSS sublayer. The DLS manages the transmit queue, creates and destroys DLEs for connection-oriented communications, provides facilities for the LME to manage the DLS, and provides facilities for connectionless communications.

Data terminal equipment (DTE). A DTE is an endpoint of a subnetwork connection.

Extended Golay Code. An error correction code capable of correcting multiple bit errors.

Frame. The link layer frame is composed of a sequence of address, control, FCS and information fields. For VDL Mode 2, these fields are bracketed by opening and closing flag sequences, and a frame may or may not include a variable-length information field.

Gaussian filtered frequency shift keying (GFSK). A continuous-phase, frequency shift keying technique using two tones and a Gaussian pulse shape filter.

Global signalling channel (GSC). A channel available on a worldwide basis which provides for communication control.

Link. A link connects an aircraft DLE and a ground DLE and is uniquely specified by the combination of aircraft DLS address and the ground DLS address. A different subnetwork entity resides above every link endpoint.

Link layer. The layer that lies immediately above the physical layer in the Open Systems Interconnection protocol model. The link layer provides for the reliable transfer of information across the physical media. It is subdivided into the data link sublayer and the media access control sublayer.

Link management entity (LME). A protocol state machine capable of acquiring, establishing and maintaining a connection to a single peer system. An LME establishes data link and subnetwork connections, “hands-off” those connections, and manages the media access control sublayer and physical layer. An aircraft LME tracks how well it can communicate with the ground stations of a single ground system. An aircraft VME instantiates an LME for each ground station that it monitors. Similarly, the ground VME instantiates an LME for each aircraft that it monitors. An LME is deleted when communication with the peer system is no longer viable.

M burst. A management channel data block of bits used in VDL Mode 3. This burst contains signalling information needed for media access and link status monitoring.

Media access control (MAC). The sublayer that acquires the data path and controls the movement of bits over the data path.

Mode 2. A data-only VDL mode that uses D8PSK modulation and a carrier sense multiple access (CSMA) control scheme.

Mode 3. A voice and data VDL mode that uses D8PSK modulation and a TDMA media access control scheme.

Mode 4. A data-only VDL mode using a GFSK modulation scheme and self-organizing time division multiple access (STDMA).

Physical layer. The lowest level layer in the Open Systems Interconnection protocol model. The physical layer is concerned with the transmission of binary information over the physical medium (e.g. VHF radio).

Quality of service. The information relating to data transfer characteristics used by various communication protocols to achieve various levels of performance for network users.

Reed-Solomon code. An error correction code capable of correcting symbol errors. Since symbol errors are collections of bits, these codes provide good burst error correction capabilities.

Self-organizing time division multiple access (STDMA). A multiple access scheme based on time-shared use of a radio frequency (RF) channel employing: (1) discrete contiguous time slots as the fundamental shared resource; and (2) a set of operating protocols that allows users to mediate access to these time slots without reliance on a master control station.

Slot. One of a series of consecutive time intervals of equal duration. Each burst transmission starts at the beginning of a slot.

Subnetwork connection. A long-term association between an aircraft DTE and a ground DTE using successive virtual calls to maintain context across link handoff.

Subnetwork dependent convergence function (SND CF). A function that matches the characteristics and services of a particular subnetwork to those characteristics and services required by the internetwork facility.

Subnetwork entity. In this document, the phrase “ground DCE” will be used for the subnetwork entity in a ground station communicating with an aircraft; the phrase “ground DTE” will be used for the subnetwork entity in a ground router

communicating with an aircraft station; and, the phrase “aircraft DTE” will be used for the subnetwork entity in an aircraft communicating with the station. A subnetwork entity is a packet layer entity as defined in ISO 8208.

Subnetwork layer. The layer that establishes, manages and terminates connections across a subnetwork.

System. A VDL-capable entity. A system comprises one or more stations and the associated VDL management entity. A system may either be an aircraft system or a ground system.

Time division multiple access (TDMA). A multiple access scheme based on time-shared use of an RF channel employing: (1) discrete contiguous time slots as the fundamental shared resource; and (2) a set of operating protocols that allows users to interact with a master control station to mediate access to the channel.

User group. A group of ground and/or aircraft stations which share voice and/or data connectivity. For voice communications, all members of a user group can access all communications. For data, communications include point-to-point connectivity for air-to-ground messages, and point-to-point and broadcast connectivity for ground-to-air messages.

VDL management entity (VME). A VDL-specific entity that provides the quality of service requested by the ATN-defined SN_SME. A VME uses the LMEs (that it creates and destroys) to enquire the quality of service available from peer systems.

VDL Mode 4 burst. A VHF digital link (VDL) Mode 4 burst is composed of a sequence of source address, burst ID, information, slot reservation and frame check sequence (FCS) fields, bracketed by opening and closing flag sequences.

Note.— The start of a burst may occur only at quantized time intervals and this constraint allows the propagation delay between the transmission and reception to be derived.

VDL Mode 4 DLS system. A VDL system that implements the VDL Mode 4 DLS and subnetwork protocols to carry ATN packets or other packets.

VDL Mode 4 specific services (VSS) sublayer. The sublayer that resides above the MAC sublayer and provides VDL Mode 4 specific access protocols including reserved, random and fixed protocols.

VDL station. An aircraft-based or ground-based physical entity, capable of VDL Mode 2, 3 or 4.

Note.— In the context of this chapter, a VDL station is also referred to as a “station”.

Vocoder. A low bit rate voice encoder/decoder.

Voice unit. A device that provides a simplex audio and signalling interface between the user and VDL.

VSS user. A user of the VDL Mode 4 specific services. The VSS user could be higher layers in the VDL Mode 4 SARPs or an external application using VDL Mode 4.

6.1.2 Radio channels and functional channels

6.1.2.1 *Aircraft station radio frequency range.* An aircraft station shall be capable of tuning to any of the channels in the range specified in Section 6.1.4.1 within 100 milliseconds after the receipt of an autotune command. In addition, for VDL Mode 3, an aircraft station shall be able to tune to any channel in the range specified in Section 6.1.4.1 within 100 milliseconds after the receipt of any tuning command.

6.1.2.2 *Ground station radio frequency range.* A ground station shall be capable of operating on its assigned channel within the radio frequency range detailed in 6.1.4.1.

6.1.2.3 *Common signalling channel.* Frequency 136.975MHz shall be reserved as a worldwide common signalling channel (CSC) for VDL Mode 2.

6.1.3 System capabilities

6.1.3.1 *Data transparency.* The VDL system shall provide code-independent, byte-independent transfer of data.

6.1.3.2 *Broadcast.* The VDL system shall provide link layer data broadcast services (Mode 2) and/or voice and data broadcast services (Mode 3). For VDL Mode 3, the data broadcast service shall support network multicasting capability originating from the ground.

6.1.3.3 *Connection management.* The VDL system shall establish and maintain a reliable communications path between the aircraft and the ground system while allowing but not requiring manual intervention.

Note.— In this context “reliable” is defined by the BER requirement specified in 6.3.5.1.

6.1.3.4 *Ground network transition.* A VDL-equipped aircraft shall transition from one ground station to another when circumstances dictate.

6.1.3.5 *Voice capability.* The VDL Mode 3 system shall support a transparent, simplex voice operation based on a “Listen-Before-Push-To-Talk” channel access.

6.1.4 Air-ground VHF digital link communications system characteristics

6.1.4.1 The radio frequencies used shall be selected from the radio frequencies in the band 117.975–137 MHz. The lowest assignable frequency shall be 118.000 MHz, and the highest assignable frequency shall be 136.975 MHz. The separation between assignable frequencies (channel spacing) shall be 25 kHz.

Note.— Volume V specifies that the block of frequencies from 136.9 – 136.975 MHz inclusive is reserved for VHF air-ground digital communications.

6.1.4.2 The design polarization of emissions shall be vertical.

6.2 SYSTEM CHARACTERISTICS OF THE GROUND INSTALLATION

6.2.1 Ground station transmitting function

6.2.1.1 *Frequency stability.* The radio frequency of VDL ground station equipment operation shall not vary more than plus or minus 0.0002 per cent (2 parts per million) from the assigned frequency.

Note.— The frequency stability for VDL ground stations using DSB-AM modulation is specified in Part II, Chapter 2 for 25 kHz channel spacing.

6.2.2 Power

Recommendation.— The effective radiated power should be such as to provide a field strength of at least 75 microvolts per metre (minus 109 dBW/m²) within the defined operational coverage of the facility, on the basis of free-space propagation.

6.2.3 Spurious emissions

6.2.3.1 Spurious emissions shall be kept at the lowest value which the state of the technique and the nature of the service permit.

Note.— Appendix S3 to the Radio Regulations specifies the levels of spurious emissions to which transmitters must conform.

6.2.4 Adjacent channel emissions

6.2.4.1 The amount of power from a VDL ground transmitter under all operating conditions when measured over the 25 kHz channel bandwidth of the first adjacent channel shall not exceed 0 dBm.

6.2.4.1.1 After 1 January 2002, the amount of power from all new installations of a VDL ground transmitter under all operating conditions when measured over the 25 kHz channel bandwidth of the first adjacent channel shall not exceed 2 dBm.

6.2.4.2 The amount of power from a VDL ground transmitter under all operating conditions when measured over the 25 kHz channel bandwidth of the second adjacent channel shall be less than minus 25 dBm and from thereon it shall monotonically decrease at the minimum rate of 5 dB per octave to a maximum value of minus 52 dBm.

6.2.4.2.1 After 1 January 2002, the amount of power from all new installations of a VDL ground transmitter under all operating conditions when measured over the 25 kHz channel bandwidth of the second adjacent channel shall be less than minus 28 dBm.

6.2.4.2.2 After 1 January 2002, the amount of power from all new installations of a VDL ground transmitter under all operating conditions when measured over the 25 kHz channel bandwidth of the fourth adjacent channel shall be less than minus 38 dBm, and from thereon it shall monotonically decrease at the minimum rate of 5 dB per octave to a maximum value of minus 53 dBm.

6.2.4.3 The amount of power from a VDL ground transmitter under all operating conditions when measured over a 16 kHz channel bandwidth centred on the first adjacent channel shall not exceed minus 20 dBm.

6.2.4.3.1 After 1 January 2002, the amount of power from all new installations of a VDL ground transmitter under all operating conditions when measured over a 16 kHz channel bandwidth centred on the first adjacent channel shall not exceed minus 18 dBm.

6.2.4.4 After 1 January 2005, all VDL ground transmitters shall meet the provisions of 6.2.4.1.1, 6.2.4.2.1, 6.2.4.2.2 and 6.2.4.3.1, subject to the conditions of 6.2.4.5.

6.2.4.5 Requirements of mandatory compliance of the provisions of 6.2.4.4 shall be made on the basis of regional air navigation agreements which specify the airspace of operation and the implementation timescales. The agreements shall provide at least two years' notice of mandatory compliance of ground systems.

6.3 SYSTEM CHARACTERISTICS OF THE AIRCRAFT INSTALLATION

6.3.1 *Frequency stability.* The radio frequency of VDL aircraft equipment shall not vary more than plus or minus 0.0005 per cent (5 parts per million) from the assigned frequency.

6.3.2 *Power.* The effective radiated power shall be such as to provide a field strength of at least 20 microvolts per metre (minus 120 dBW/m²) on the basis of free-space propagation, at ranges and altitudes appropriate to the operational conditions pertaining to the areas over which the aircraft is operated.

6.3.3 Spurious emissions

6.3.3.1 Spurious emissions shall be kept at the lowest value which the state of the technique and the nature of the service permit.

Note.— Appendix S3 to the Radio Regulations specifies the levels of spurious emissions to which transmitters must conform.

6.3.4 Adjacent channel emissions

6.3.4.1 The amount of power from a VDL aircraft transmitter under all operating conditions when measured over the 25 kHz channel bandwidth of the first adjacent channel shall not exceed 0 dBm.

6.3.4.1.1 After 1 January 2002, the amount of power from all new installations of a VDL aircraft transmitter under all operating conditions when measured over the 25 kHz channel bandwidth of the first adjacent channel shall not exceed 2 dBm.

6.3.4.2 The amount of power from a VDL aircraft transmitter under all operating conditions when measured over the 25 kHz channel bandwidth of the second adjacent channel shall be less than minus 25 dBm and from thereon it shall monotonically decrease at the minimum rate of 5 dB per octave to a maximum value of minus 52 dBm.

6.3.4.2.1 After 1 January 2002, the amount of power from all new installations of a VDL aircraft transmitter under all operating conditions when measured over the 25 kHz channel bandwidth of the second adjacent channel shall be less than minus 28 dBm.

6.3.4.2.2 After 1 January 2002, the amount of power from all new installations of a VDL aircraft transmitter under all operating conditions when measured over the 25 kHz channel bandwidth of the fourth adjacent channel shall be less than minus 38 dBm, and from thereon it shall monotonically decrease at the minimum rate of 5 dB per octave to a maximum value of minus 53 dBm.

6.3.4.3 The amount of power from a VDL aircraft transmitter under all operating conditions when measured over a 16 kHz channel bandwidth centred on the first adjacent channel shall not exceed minus 20 dBm.

6.3.4.3.1 After 1 January 2002, the amount of power from all new installations of a VDL aircraft transmitter under all operating conditions when measured over a 16 kHz channel bandwidth centred on the first adjacent channel shall not exceed minus 18 dBm.

6.3.4.4 After 1 January 2005, all VDL aircraft transmitters shall meet the provisions of 6.3.4.1.1, 6.3.4.2.1, 6.3.4.2.2 and 6.3.4.3.1, subject to the conditions of 6.3.4.5.

6.3.4.5 Requirements of mandatory compliance of the provisions of 6.3.4.4 shall be made on the basis of regional air navigation agreements which specify the airspace of operation and the implementation timescales. The agreements shall provide at least two years' notice of mandatory compliance of aircraft systems.

6.3.5 Receiving function

6.3.5.1 *Specified error rate.* The specified error rate for Mode 2 operation shall be the maximum corrected Bit Error Rate (BER) of 1 in 10^4 . The specified error rate for Mode 3 operation shall be the maximum uncorrected BER of 1 in 10^3 . The specified error rate for Mode 4 operation shall be the maximum uncorrected BER of 1 in 10^4 .

Note.— The above physical layer BER requirements are derived from the BER requirement imposed by ATN at the subnetwork interface.

6.3.5.2 *Sensitivity.* The receiving function shall satisfy the specified error rate with a desired signal strength of not more than 20 microvolts per metre (minus 120 dBW/m²).

Note.— The required signal strength at the edge of the service volume takes into account the requirements of the system and signal losses within the system, and considers environmental noise sources.

6.3.5.3 *Out-of-band immunity performance.* The receiving function shall satisfy the specified error rate with a desired signal field strength of not more than 40 microvolts per metre (minus 114 dBW/m²) and with an undesired DSB-AM D8PSK or GFSK signal on the adjacent or any other assignable channel being at least 40 dB higher than the desired signal.

6.3.5.3.1 After 1 January 2002, the receiving function of all new installations of VDL shall satisfy the specified error rate with a desired signal field strength of not more than 40 microvolts per metre (minus 114 dBW/m²) and with an undesired VHF DSB-AM, D8PSK or GFSK signal at least 60 dB higher than the desired signal on any assignable channel 100 kHz or more away from the assigned channel of the desired signal.

Note.— This level of interference immunity performance provides a receiver performance consistent with the influence of the VDL RF spectrum mask as specified in 6.3.4 with an effective isolation transmitter/receiver isolation of 69 dB. Better transmitter and receiver performance could result in less isolation required. Guidance material on the measurement technique is included in the Handbook on Radio Frequency Spectrum Requirements for Civil Aviation including statement of approved ICAO policies (Doc 9718).

6.3.5.3.2 After 1 January 2005, the receiving function of all installations of VDL shall meet the provisions of 6.3.5.3.1, subject to the conditions of 6.3.5.3.3.

6.3.5.3.3 Requirements of mandatory compliance of the provisions of 6.3.5.3.2 shall be made on the basis of regional air navigation agreements which specify the airspace of operation and the implementation timescales. The agreement shall provide for at least two years' notice of mandatory compliance of aircraft systems.

6.3.5.4 INTERFERENCE IMMUNITY PERFORMANCE

6.3.5.4.1 The receiving function shall satisfy the specified error rate with a desired field strength of not more than 40 microvolts per metre, and with one or more out-of-band signals, except for VHF FM broadcast signals, having a total level at the receiver input of minus 33 dBm.

Note.— In areas where adjacent higher band signal interference exceeds this specification, a higher immunity requirement will apply.

6.3.5.4.2 The receiving function shall satisfy the specified error rate with a desired field strength of not more than 40 microvolts per metre, and with one or more VHF FM broadcast signals having a total level at the receiver input of minus 5 dBm.

6.4 PHYSICAL LAYER PROTOCOLS AND SERVICES

The aircraft and ground stations shall access the physical medium operating in simplex mode.

6.4.1 Functions

6.4.1.1 The physical layer shall provide the following functions:

- a) transmitter and receiver frequency control;

- b) digital reception by the receiver;
- c) digital transmission by the transmitter; and
- d) notification services.

6.4.1.1.1 *Transmitter/receiver frequency control.* The VDL physical layer shall set the transmitter or receiver frequency as commanded by the link management entity (LME).

Note.— The LME is a link layer entity as contained in the Manuals on VDL Mode 2 and VDL Mode 3 Technical Specifications.

6.4.1.1.2 *Digital reception by the receiver.* The receiver shall decode input signals and forward them to the higher layers for processing.

6.4.1.1.3 *Digital transmission.* The VDL physical layer shall appropriately encode and transmit information received from higher layers over the RF channel.

6.4.2 Modes 2 and 3 common physical layer

6.4.2.1 *Modulation scheme.* Modes 2 and 3 shall use differentially encoded 8 phase shift keying (D8PSK), using a raised cosine filter with $\alpha = 0.6$ (nominal value). The information to be transmitted shall be differentially encoded with 3 bits per symbol (baud) transmitted as changes in phase rather than absolute phase. The data stream to be transmitted shall be divided into groups of 3 consecutive data bits, least significant bit first. Zeros shall be padded to the end of the transmissions if needed for the final channel symbol.

6.4.2.1.1 *Data encoding.* A binary data stream entering a differential data encoder shall be converted into three separate binary streams X, Y, and Z so that bits $3n$ form X, bits $3n + 1$ form Y, and bits $3n + 2$ form Z. The triplet at time k (X_k, Y_k, Z_k) shall be converted to a change in phase as shown in Table 6-1*, and the absolute phase ϕ_k is the accumulated series of $\Delta\phi_k$, that is:

$$\phi_k = \phi_{k-1} + \Delta\phi_k$$

6.4.2.1.2 *Transmitted signal form.* The phase-modulated baseband signal as defined in 6.4.2.1.1 shall excite the pulse shape filter.

$$s(t) = \sum_{k=-\infty}^{+\infty} h(\phi_k, t - kT_s)$$

where:

- h is the complex impulse response of the pulse shape filter;
- k is defined in 6.4.2.1.1;
- ϕ is defined by the equation in 6.4.2.1.1;
- t is time;
- T_s is time duration of each symbol.

The output (function of time) of the pulse shape filter ($s(t)$) shall modulate the carrier frequency. The pulse shape filter shall have a nominal complex frequency response of a raised-cosine filter with $\alpha = 0.6$.

* All tables are located at the end of this chapter.

6.4.2.2 *Modulation rate.* The symbol rate shall be 10 500 symbols/second, resulting in a nominal bit rate of 31 500 bits/s. The modulation stability requirements for Modes 2 and 3 are provided in Table 6-2.

6.4.3 Mode 2 specific physical layer

Note.— *The Mode 2 specific physical layer specification includes a description of the Mode 2 training sequence, forward error correction (FEC), interleaving, bit scrambling, channel sensing, and physical layer system parameters.*

6.4.3.1 To transmit a sequence of frames, a station shall insert the bit numbers and flags (per the data link service description for Mode 2 as contained in the Manual on VDL Mode 2 Technical Specifications), compute the FEC (per 6.4.3.1.2), interleave (per 6.4.3.1.3), prepend the training sequence (per 6.4.3.1.1), carry out bit scrambling (per 6.4.3.1.4) and finally encode and modulate the RF signal (per 6.4.2.1).

6.4.3.1.1 *Training sequence.* Data transmission shall begin with a demodulator training sequence consisting of five segments:

- a) transmitter ramp-up and power stabilization;
- b) synchronization and ambiguity resolution;
- c) reserved symbol;
- d) transmission length; and
- e) header FEC.

Note.— *Immediately after these segments follows an AVLC frame with the format as contained in the data link service description in the Manual on VDL Mode 2 Technical Specifications.*

6.4.3.1.1.1 *Transmitter ramp-up and power stabilization.* The purpose of the first segment of the training sequence, called the ramp-up, is to provide for transmitter power stabilization and receiver AGC settling, and it shall immediately precede the first symbol of the unique word. The duration of the ramp-up shall be five symbol periods. The time reference point (t), for the following specification is the centre of the first unique word symbol, a point that occurs half a symbol period after the end of the ramp-up. Conversely stated, the beginning of the ramp-up starts at $t = -5.5$ symbol periods. The transmitted power shall be less than -40 dBc prior to time $t = -5.5$ symbol periods. The ramp-up shall provide that at time $t = -3.0$ symbol periods the transmitted power is 90 per cent of the manufacturer's stated output power or greater (see Figure 6-1*). Regardless of the method used to implement (or truncate) the raised cosine filter, the output of the transmitter between times $t = -3.0$ and $t = -0.5$ will appear as if '000' symbols were transmitted during the ramp-up period.

Note. 1.— *For Mode 3, the timing reference point is the same as the "power reference point".*

Note 2.— *It is desirable to maximize the time allowed for the AGC settling time. Efforts should be made to have power above 90 per cent of nominal output power at $t - 3.5$ symbol periods.*

6.4.3.1.1.2 *Synchronization and ambiguity resolution.* The second segment of the training sequence shall consist of the unique word:

000 010 011 110 000 001 101 110 001 100 011 111 101 111 100 010

and shall be transmitted from left to right.

* All figures are located at the end of this chapter.

6.4.3.1.1.3 *Reserved symbol.* The third segment of the training sequence shall consist of the single symbol representing 000.

Note.— This field is reserved for future definition.

6.4.3.1.1.4 *Transmission length.* To allow the receiver to determine the length of the final Reed-Solomon block, the transmitter shall send a 17-bit word, from least significant bit (lsb) to most significant bit (msb), indicating the total number of data bits that follow the header FEC.

Note.— The length does not include those bits transmitted for: the Reed Solomon FEC, extra bits padded to ensure that the interleaver generates an integral number of 8-bit words, or the extra bits padded to ensure that the data encoder generates an integral number of 3-bit symbols.

6.4.3.1.1.5 *Header FEC.* To correct bit errors in the header, a (25, 20) block code shall be computed over the reserved symbol and the transmission length segments. The block code shall be transmitted as the fifth segment. The encoder shall accept the header in the bit sequence that is being transmitted. The five parity bits to be transmitted shall be generated using the following equation:

$$[P_1, \dots, P_5] = [R_1, \dots, R_3, TL_1, \dots, TL_{17}] H^T$$

where:

P is the parity symbol (P₁ shall be transmitted first);

R is the reserved symbol;

TL is the transmission Length symbol;

^T is the matrix transpose function; and

H is the parity matrix defined below:

$$H = \begin{bmatrix} 0 & 0 & 0 & 0 & 0 & 0 & 0 & 0 & 1 & 1 & 1 & 1 & 1 & 1 & 1 & 1 & 1 & 1 & 1 & 1 \\ 0 & 0 & 1 & 1 & 1 & 1 & 1 & 1 & 0 & 0 & 0 & 0 & 1 & 1 & 1 & 1 & 1 & 1 & 1 & 1 \\ 1 & 1 & 0 & 0 & 0 & 1 & 1 & 1 & 0 & 0 & 1 & 1 & 0 & 0 & 0 & 0 & 1 & 1 & 1 & 1 \\ 1 & 1 & 0 & 1 & 1 & 0 & 1 & 1 & 0 & 1 & 0 & 1 & 0 & 0 & 1 & 1 & 0 & 0 & 1 & 1 \\ 0 & 1 & 1 & 0 & 1 & 0 & 0 & 1 & 1 & 1 & 1 & 0 & 0 & 1 & 0 & 1 & 0 & 1 & 0 & 1 \end{bmatrix}$$

6.4.3.1.1.6 *Bit transmission order.* The five parity bits of the resultant vector product shall be transmitted from the left bit first.

6.4.3.1.2 *Forward error correction.* In order to improve the effective channel throughput by reducing the number of required retransmissions, FEC shall be applied after the training sequence, regardless of frame boundaries.

6.4.3.1.2.1 *FEC calculation.* The FEC coding shall be accomplished by means of a systematic fixed-length Reed-Solomon (RS)(255,249) 2⁸-ary code.

Note 1.— This code is capable of correcting up to three octets for data blocks of 249 octets (1992 bits). Longer transmissions must be divided up into 1992 bit transmissions and shorter transmissions must be extended by virtual fill with trailing zeros. Six RS-check octets are appended for a total block of 255 octets.

The field defining the primitive polynomial of the code shall be as follows:

$$p(x) = (x^8 + x^7 + x^2 + x + 1)$$

The generator polynomial shall be as follows:

$$\prod_{i=120}^{125} (x - \alpha^i)$$

where:

α is a primitive element of GF(256);
GF(256) is a Galois field (GF) of size 256.

Note 2.— The Reed-Solomon codes are described in the Recommendation for Space Data System Standards Telemetry Channel Coding, by the Consultative Committee for Space Data Systems (see the Appendix to this chapter).

6.4.3.1.2.2 *Block lengths.* The six RS-check octets shall be calculated on blocks of 249 octets. Longer transmissions shall be split into blocks of 249 octets, per 6.4.3.1.3. Blocks of shorter length shall be extended to 249 octets by a virtual fill of trailing zeros. The virtual fill shall not be transmitted. Blocks shall be coded according to 6.4.3.1.2.3 through 6.4.3.1.2.3.3.

6.4.3.1.2.3 *No error correction.* For blocks with 2 or fewer non-fill octets, no error correction shall be used.

6.4.3.1.2.3.1 *Single-byte error correction.* For blocks with 3 to 30 non-fill octets, all six RS-check octets shall be generated, but only the first two shall be transmitted. The last four RS-check octets shall be treated as erasures at the decoder.

6.4.3.1.2.3.2 *Two-byte error correction.* For blocks with 31 to 67 non-fill octets, all six RS-check octets shall be generated, but only the first four shall be transmitted. The last two RS-check octets shall be treated as erasures at the decoder.

6.4.3.1.2.3.3 *Three-byte error correction.* For blocks with 68 or more non-fill octets, all six RS-check octets shall be generated and transmitted.

6.4.3.1.3 *Interleaving.* To improve the performance of the FEC, an octet-based table-driven interleaver shall be used. The interleaver shall create a table having 255 octets per row and c rows, where

$$c = \frac{\text{transmission length (bits)}}{1992 \text{ (bits)}}$$

where:

- a) the transmission length is as defined in 6.4.3.1.1.5; and
- b) c = the smallest integer greater than or equal to the value of the fraction.

After extending the data to an even multiple of 1992 bits, the interleaver shall write the transmission stream into the first 249 octets of each row by taking each consecutive group of eight bits and storing them from the first column to the 249th. The first bit in each group of eight bits shall be stored in the eighth bit position; the first group of 1992 bits shall be stored in the first row, the second group of 1992 bits in the second row, etc. After the FEC is computed on each row, the FEC data (or erasures) shall be stored in columns 250 through 255. The interleaver shall then pass the data to the scrambler by reading out column by column, skipping any octet which contains erasures or all fill bits. All of the bits in an octet shall be transmitted from bit 8 to bit 1.

On reception, the de-interleaver shall calculate the number of rows and size of the last (potentially partial) row from the length field in the header. It shall only pass valid data bytes to the higher layer.

6.4.3.1.4 *Bit scrambling.* To aid clock recovery and to stabilize the shape of the transmitted spectrum, bit scrambling shall be applied. The pseudo noise (PN) sequence shall be a 15-stage generator (see Figure 6-2) with the characteristic polynomial:

$$X^{15} + X + 1$$

The PN-sequence shall start after the frame synchronization pattern with the initial value 1101 0010 1011 001 with the left-most bit in the first stage of the register as per Figure 6-2. After processing each bit, the register shall be shifted one bit to the right. For possible encryption in the future this initial value shall be programmed. The sequence shall be added (modulo 2) to the data at the transmit side (scrambling) and to the scrambled data at the receive side (descrambling) per Table 6-3.

Note.— The concept of a PN scrambler is explained in ITU-R Recommendation S.446-4, Annex I, Section 4.3.1, Method 1 (see the Appendix to this chapter).

6.4.3.2 MODE 2 CHANNEL SENSING

6.4.3.2.1 *Channel busy to idle detection.* When a station receives on-channel power of at least -87 dBm for at least 5 milliseconds, then:

- a) with a likelihood of 0.9, it shall continue to consider the channel occupied if the signal level is attenuated to below -92 dBm for less than 1 millisecond; and
- b) with a likelihood of 0.9, it shall consider the channel unoccupied if the signal level is attenuated to below -92 dBm for at least 1.5 milliseconds.

Note.— The maximum link throughput available to all users is highly sensitive to the RF channel sense delay (from the time when the channel actually changes state until a station detects and acts on that change) and RF channel seizure delay (from the time when a station decides to transmit until the transmitter is sufficiently ramped up to lock out other stations). Accordingly, it is imperative that all efforts are made to reduce those times as the state-of-the-art advances.

6.4.3.2.2 *Channel idle to busy detection.* With a likelihood of at least 0.9, a station shall consider the channel occupied within 1 millisecond after on-channel power rises to at least -90 dBm.

6.4.3.2.3 **Recommendation.**— *The detection of an occupied channel should occur within 0.5 milliseconds.*

Note.— A higher probability of false alarm is acceptable on the idle to busy detection than the busy to idle detection because of the effects of the two different errors.

6.4.3.3 MODE 2 RECEIVER/TRANSMITTER INTERACTION

6.4.3.3.1 *Receiver to transmitter turnaround time.* A station shall transmit the training sequence such that the centre of the first symbol of the unique word will be transmitted within 1.25 milliseconds after the result of an access attempt is successful (see Figure 6-3). The total frequency change during the transmission of the unique word shall be less than 10 Hz. After transmission of the unique word, the phase acceleration shall be less than 500 Hz per second.

6.4.3.3.2 *Transmitter to receiver turnaround time.* The transmitter power shall be -20 dBc within 2.5 symbol periods of the middle of the final symbol of the burst. The transmitter power leakage when the transmitter is in the “off” state shall be less than -83 dBm. A station shall be capable of receiving and demodulating with nominal performance, an incoming signal within 1.5 milliseconds after transmission of the final information symbol.

Note.— Reference DO-160D section 21, category H for antenna radiated signals.

6.4.3.4 MODE 2 PHYSICAL LAYER SYSTEM PARAMETERS

6.4.3.4.1 The physical layer shall implement the system parameters as defined in Table 6-4.

6.4.3.4.1.1 *Parameter P1 (minimum transmission length)*. Parameter P1 defines the minimum transmission length that a receiver shall be capable of demodulating without degradation of BER.

6.4.4 Mode 3 specific physical layer

Note.— The Mode 3 specific physical layer specification includes a description of Mode 3 management (M) burst and handoff check message (H) burst uplink, M burst downlink, voice/data (V/D) burst, and bit scrambling.

6.4.4.1 *Management (M) burst and handoff check message (H) burst uplink*. The M uplink burst (as contained in the Manual on VDL Mode 3 Technical Specifications) shall consist of three segments, the training sequence followed by the system data and the transmitter ramp down. The H uplink burst (as contained in the Manual on VDL Mode 3 Technical Specifications) shall consist of three segments, the training sequence followed by the handoff check message and the transmitter ramp down.

6.4.4.1.1 *Training sequence*. Uplink M burst and H burst training sequences shall consist of two components as follows:

- a) transmitter ramp up and power stabilization; and
- b) synchronization and ambiguity resolution.

6.4.4.1.1.1 *Transmitter ramp-up and power stabilization*. This shall be as defined in Section 6.4.3.1.1.1.

6.4.4.1.1.2 *Synchronization and ambiguity resolution*. The second component of the training sequence shall consist of the synchronization sequence, known as S_2^* , as follows:

000 001 101 100 110 010 111 100 010 011 101 000 111 000 011 001

and shall be transmitted from left to right.

Note.— The sequence S_2^* is very closely related to the sequence S_2 (Section 6.4.4.3.1.2). The 15 phase changes between the 16 symbols of S_2^* are each exactly 180° out of phase from the 15 phase changes associated with S_2 . This relationship can be used to simplify the process of simultaneously searching for both sequences.

6.4.4.1.2 *System data and handoff check message*. The non-3T configuration (as contained in the Manual on VDL Mode 3 Technical Specifications) system data shall consist of 32 transmitted symbols. The 96 transmitted bits shall include 48 bits of information and 48 parity bits, generated as 4 Golay (24, 12) code words. The 3T configuration as contained in the Manual on VDL Mode 3 Technical Specifications shall consist of 128 transmitted symbols. The 384 transmitted bits shall include 192 bits of information and 192 parity bits, generated as 16 Golay (24, 12) code words. The 3T configuration handoff check message shall consist of 40 transmitted symbols. The 120 transmitted bits shall include 60 bits of information and 60 parity bits, generated as 5 Golay (24,12) code words.

The specific definition of the Golay encoder shall be as follows:

If the 12 bit input bit sequence is written as a row vector \mathbf{x} , then the 24 bit output sequence can be written as the row vector \mathbf{y} , where $\mathbf{y} = \mathbf{x} \mathbf{G}$, and the matrix \mathbf{G} shall be given by

```

1 1 0 1 0 1 1 1 0 0 0 1 1 0 0 0 0 0 0 0 0 0 0 0 0
0 1 1 1 1 1 0 0 1 0 0 1 0 1 0 0 0 0 0 0 0 0 0 0 0
1 1 1 0 1 0 0 1 0 1 0 1 0 0 1 0 0 0 0 0 0 0 0 0 0
0 1 1 0 0 0 1 1 1 0 1 1 0 0 0 1 0 0 0 0 0 0 0 0 0
1 1 1 0 0 1 1 0 1 1 0 0 0 0 0 0 0 1 0 0 0 0 0 0 0
G = 1 0 1 1 0 0 1 1 0 1 1 0 0 0 0 0 0 0 1 0 0 0 0 0 0
1 0 0 1 1 0 0 1 1 0 1 1 0 0 0 0 0 0 0 1 0 0 0 0 0
0 1 0 1 1 0 1 1 1 1 0 0 0 0 0 0 0 0 0 0 1 0 0 0 0
0 0 1 0 1 1 0 1 1 1 1 0 0 0 0 0 0 0 0 0 0 1 0 0 0
0 0 0 1 0 1 1 0 1 1 1 1 0 0 0 0 0 0 0 0 0 0 1 0 0
1 1 0 1 1 1 0 0 0 1 1 0 0 0 0 0 0 0 0 0 0 0 0 1 0
1 0 1 0 1 1 1 0 0 0 1 1 0 0 0 0 0 0 0 0 0 0 0 0 1

```

Note.— The extended Golay code allows for the correction of any error pattern with 3 or fewer bit errors and the detection of any 4-bit error pattern.

6.4.4.1.3 *Transmitter ramp-down.* The transmitter power shall be -20 dBc within 2.5 symbol periods of the middle of the final symbol of the burst. The transmitter power leakage when the transmitter is in the “off” state shall be less than -83 dBm.

Note.— Reference RTCA/DO-160D section 21, category H for antenna radiated signals.

6.4.4.2 *Management (M) burst downlink.* The M downlink burst (as contained in the Manual on VDL Mode 3 Technical Specifications) shall consist of three segments, the training sequence followed by the system data and the transmitter ramp down.

6.4.4.2.1 *Training sequence.* The M downlink burst training sequence shall consist of two components as follows:

- a) transmitter ramp up and power stabilization; and
- b) synchronization and ambiguity resolution.

6.4.4.2.1.1 *Transmitter ramp-up and power stabilization.* This shall be as defined in 6.4.4.1.1.1.

6.4.4.2.1.2 *Synchronization and ambiguity resolution.* Three separate synchronization sequences shall be used for this burst type. The standard sequence, known as S_1 , shall be as follows:

```
000 111 001 001 010 110 000 011 100 110 011 111 010 101 100 101
```

and shall be transmitted from left to right. The special sequence used to identify poll responses shall be as defined in 6.4.4.1.1.2.

The special sequence used to identify net entry requests (S_1^*) shall use the following sequence:

```
000 001 111 111 100 000 110 101 010 000 101 001 100 011 010 011
```

and shall be transmitted from left to right.

Note.— The sequence S_1^* is very closely related to the sequence S_1 . The 15 phase changes between the 16 symbols of S_1^* are each exactly 180° out of phase from the 15 phase changes associated with S_1 . This relationship can be used to simplify the process of simultaneously searching for both sequences.

6.4.4.2.2 *System data.* The system data segment shall consist of 16 transmitted symbols. The 48 transmitted bits shall be encoded as 24 bits of system data and 24 bits of parity bits generated as two consecutive (24, 12) Golay code words. The encoding of the (24, 12) Golay code words should be as defined in 6.4.4.1.2.

6.4.4.2.3 *Transmitter ramp-down.* This shall be as defined in 6.4.4.1.3.

6.4.4.3 *Voice or data (V/D) burst.* The V/D burst (as contained in the Manual on VDL Mode 3 Technical Specifications) shall consist of four segments: the training sequence followed by the header, the user information segment and the transmitter ramp down. The same V/D burst format shall be used for both uplink and downlink.

6.4.4.3.1 *Training sequence.* V/D burst training sequence shall consist of two components as follows:

- a) transmitter ramp-up and power stabilization; and
- b) synchronization and ambiguity resolution.

6.4.4.3.1.1 *Transmitter ramp-up and power stabilization.* This shall be as specified in 6.4.4.1.1.1.

6.4.4.3.1.2 *Synchronization and ambiguity resolution.* The second component of the training sequence shall consist of the synchronization sequence, known as S₂, as follows:

000 111 011 010 000 100 001 010 100 101 011 110 001 110 101 111

and shall be transmitted from left to right.

6.4.4.3.2 *Header.* The header segment shall consist of 8 transmitted symbols. The 24 transmitted bits shall be encoded as 12 bits of header information and 12 parity bits, generated as a single (24, 12) Golay code word. The encoding of the (24, 12) Golay code word shall be as defined in 6.4.4.1.2.

6.4.4.3.3 *User information.* The user information segment shall consist of 192 3-bit symbols. When transmitting voice, FEC shall be applied to the analysis output of the vocoder specified in 6.8. The vocoder shall provide satisfactory performance in a BER environment of 10⁻³ (with a design goal of 10⁻²). The overall bit rate of the vocoder *including FEC* is 4 800 bits/s (except when in the truncated mode in which the bit rate is 4 000 bits/s).

6.4.4.3.3.1 When transmitting user data, the 576 bits shall be encoded as a single Reed-Solomon (72, 62) 2⁸-ary code word. For user data input to the Reed-Solomon encoder of length less than 496 bits, input data shall be padded with zeroes at the end to a full length of 496 bits. The field defining the primitive polynomial of the code shall be as described in 6.4.3.1.2.1. The generator polynomial shall be as follows:

$$\prod_{i=120}^{129} (x - \alpha^i)$$

Note.— The Reed-Solomon (72, 62) code is capable of correcting up to five 2⁸-ary (code word) symbol errors in the received word.

6.4.4.3.4 *Transmitter ramp-down.* This shall be as defined in 6.4.4.1.3.

6.4.4.4 *Interleaving.* There shall be no interleaving in Mode 3 operation.

6.4.4.5 *Bit scrambling.* Under Mode 3 operation, bit scrambling, as specified in 6.4.3.1.4 shall be performed on each burst, starting after the training sequence. The scrambling sequence shall be reinitialized on each burst effectively providing a constant overlay for each of the Mode 3 fixed length bursts.

6.4.4.6 *Receiver/transmitter interaction.* The switching times in this subsection will be defined as the time between the middle of the last information symbol of one burst and the middle of the first symbol of the synchronization sequence of the subsequent burst.

Note.— *This nominal time will be shortened by considerations such as the finite width of each symbol due to Nyquist filtering and the ramp up and power stabilization sequence. Such alternative definitions could yield switching times up to 8 symbol periods shorter.*

6.4.4.6.1 *Receiver to transmitter switching time.* An aircraft radio shall be capable of switching from reception to transmission within 17 symbol periods. This time can be relaxed to 33 symbol periods for aircraft radios which do not implement functions requiring discrete addressing.

Note 1.— *The shortest R/T switching time for an aircraft radio occurs when the reception of an uplink M channel beacon is followed by a V/D transmission in the same slot. In certain instances where aircraft radios do not implement functions requiring discrete addressing, the R/T switching time can be increased since the last two Golay words of the uplink M channel beacon need not be read.*

Note 2.— *The minimum turnaround time assumes that in configurations 3VID, 2VID, and 3T (as contained in Section 5.5.2.4 of the Manual on VDL Mode 3 Technical Specifications), the aircraft radios will be provided with software that will prevent them from transmitting a downlink M channel message in a slot following the reception of a voice message from another aircraft with a long time delay.*

6.4.4.6.2 *Transmitter to receiver switching time.* An aircraft radio shall be capable of switching from transmission to reception within 32 symbol periods.

Note.— *The worst case T/R switching time for an aircraft radio occurs when it transmits a downlink M channel message and receives a V/D message in the same slot.*

6.4.4.7 *Fringe coverage indication*

6.4.4.7.1 **Recommendation.**— *Indication of near edge-of-coverage should be provided to the VDL Mode 3 aircraft.*

6.5 LINK LAYER PROTOCOLS AND SERVICES

6.5.1 General information

6.5.1.1 *Functionality.* The VDL link layer shall provide the following sublayer functions:

- a) media access control (MAC) sublayer, which requires the use of the carrier sense multiple access (CSMA) algorithm for Mode 2 or TDMA for Mode 3;
- b) a data link service (DLS) sublayer:
 - 1) for Mode 2, the DLS sublayer provides connection-oriented point-to-point links using data link entities (DLE) and connectionless broadcast link over the MAC sublayer; and
 - 2) for Mode 3, the DLS sublayer provides acknowledged connectionless point-to-point and point-to-multipoint links over a MAC sublayer that guarantees sequencing; and
- c) a VDL management entity (VME), which establishes and maintains DLEs between the aircraft and the ground-based systems using link management entities (LME).

6.5.1.2 SERVICE

6.5.1.2.1 *Connection-oriented.* The VDL Mode 2 link layer shall provide a reliable point-to-point service using a connection-oriented DLS sublayer.

6.5.1.2.2 *Connectionless.* The VDL Mode 2 and 3 link layers shall provide an unacknowledged broadcast service using a connectionless DLS sublayer.

6.5.1.2.3 *Acknowledged connectionless.* The VDL Mode 3 link layer shall provide an acknowledged point-to-point service using a connectionless DLS sublayer that relies upon the MAC sublayer to guarantee sequencing.

6.5.2 MAC sublayer

6.5.2.1 The MAC sublayer shall provide for the transparent acquisition of the shared communications path. It makes invisible to the DLS sublayer the way in which supporting communications resources are utilized to achieve this.

Note.— Specific MAC services and procedures for VDL Modes 2 and 3 are contained in the Manuals on VDL Mode 2 and VDL Mode 3 Technical Specifications.

6.5.3 Data link service sublayer

6.5.3.1 For Mode 2, the DLS shall support bit-oriented simplex air-ground communications using the aviation VHF link control (AVLC) protocol.

Note.— Specific data link services, parameters and protocol definitions for VDL Mode 2 are contained in the Manual on VDL Mode 2 Technical Specifications.

6.5.3.2 For Mode 3, the DLS shall support bit-oriented, priority based, simplex air-ground communications using the acknowledged connectionless data link (A-CLDL) protocol.

Note.— Specific data link services, parameters and protocol definitions for VDL Mode 3 are contained in the Manual on VDL Mode 3 Technical Specifications.

6.5.4 VDL management entity

6.5.4.1 *Services.* The VME shall provide link establishment, maintenance and disconnection services as well as support parameter modification. Specific VME services, parameter formats and procedures for Modes 2 and 3 are contained in the Manuals on VDL Mode 2 and Mode 3 Technical Specifications.

6.6 SUBNETWORK LAYER PROTOCOLS AND SERVICES

6.6.1 Architecture for Mode 2

6.6.1.1 The subnetwork layer protocol used across the VHF air-ground subnetwork for VDL Mode 2 is referred to formally as a subnetwork access protocol (SNAcP) and shall conform to ISO 8208, except as contained in the Manual on VDL Mode 2 Technical Specifications. The SNAcP is contained within the Manual on VDL Mode 2 Technical Specifications as the subnetwork protocol. If there are any differences between the Manual on VDL Mode 2 Technical

Specifications and the cited specifications, the Manual on VDL Mode 2 Technical Specifications shall have precedence. On the air-ground interface, the aircraft subnetwork entity shall act as a DTE and the ground subnetwork entity shall act as a DCE.

Note.— *Specific subnetwork layer protocol access points, services, packet formats, parameters and procedures for VDL Mode 2 are contained in the Manual on VDL Mode 2 Technical Specifications.*

6.6.2 Architecture for Mode 3

6.6.2.1 The subnetwork layer used across the VHF air-ground subnetwork for VDL Mode 3 provides the flexibility to simultaneously support multiple subnetwork protocols. The currently defined options are to support ISO 8473 connectionless network protocol and to support ISO 8208, both as contained in the Manual on VDL Mode 3 Technical Specifications. The Manual on VDL Mode 3 Technical Specifications shall have precedence with respect to any differences with the cited specifications. For the ISO 8208 interface, both the air and ground subnetwork entities shall act as DCEs.

Note.— *Specific subnetwork layer protocol access points, services, packet formats, parameters and procedures for VDL Mode 3 are contained in the Manual on VDL Mode 3 Technical Specifications.*

6.7 THE VDL MOBILE SUBNETWORK DEPENDENT CONVERGENCE FUNCTION (SNDCF)

6.7.1 VDL Mode 2 SNDCF

6.7.1.1 *Introduction.* The VDL Mode 2 mobile SNDCF shall be the standard mobile SNDCF.

6.7.1.2 *New function.* The VDL Mode 2 mobile SNDCF shall support maintaining context (e.g. compression tables) across subnetwork calls. The SNDCF shall use the same context (e.g. compression tables) across all SVCs negotiated to a DTE, when negotiated with the same parameters. The SNDCF shall support at least 2 SVCs sharing a context.

Note 1.— *Because handoffs can be expected to reorder packets, certain compression algorithms do not lend themselves to use over VDL Mode 2. Further, implementors of dictionary-based compression algorithms must be sensitive to the problem of updates arriving on either the old or newly established call.*

Note 2.— *The encoding of the Call User Data field is described in Doc 9705 except with modifications as contained in the Manual on VDL Mode 2 Technical Specifications.*

6.7.2 VDL Mode 3 SNDCF

6.7.2.1 The VDL Mode 3 shall support one or more of the defined SNDCFs. The first is the standard ISO 8208 SNDCF as defined in Doc 9705. This is a connection-oriented SNDCF. The second type of SNDCF supported by VDL Mode 3 is denoted frame-based SNDCF. The details of this connectionless oriented SNDCF are contained in the Manual on VDL Mode 3 Technical Specifications, including network layer interface, support for broadcast and unicast network packets, and ATN router support.

Note.— *The framed-based SNDCF is termed such because it uses the VDL Mode 3 frames without the need for an additional protocol (viz. ISO 8208 SNDCF) to transfer network packets. The frame-based SNDCF achieves independence from the network protocol by identifying the payload of each frame. Upon receipt of a frame, the payload is examined and control is passed to the protocol identified.*

6.8 VOICE UNIT FOR MODE 3

6.8.1 Services

6.8.1.1 The voice unit shall provide for a simplex, “push-to-talk” audio and signalling interface between the user and the VDL. Two separate mutually exclusive voice circuit types shall be supported:

- a) Dedicated circuits: This shall provide service to a specific user group on an exclusive basis with no sharing of the circuit with other users outside the group. Access shall be based on a “listen-before-push-to-talk” discipline.
- b) Demand assigned circuits: This shall provide voice circuit access which is arbitrated by the ground station in response to an access request received from the aircraft station. This type of operation shall allow dynamic sharing of the channel resource increasing trunking efficiency.

6.8.1.2 *Priority access.* The voice unit operation shall support a priority override access for authorized ground users.

6.8.1.3 *Message source identification.* The voice unit operation shall support notification to the user of the source of a received message (i.e. whether the message originated from an air or ground station).

6.8.1.4 *Coded squelch.* The voice unit shall support a coded squelch operation that offers some degree of rejection of undesired co-channel voice messages based on the burst time of arrival.

6.8.2 Speech encoding, parameters and procedures

6.8.2.1 The VDL Mode 3 shall use the advanced multiband excitation (AMBE) 4.8 kbits/s encoding/decoding algorithm, version number AMBE-ATC-10, developed by Digital Voice Systems, Incorporated (DVSI) for voice communications.

Note 1.— Information on technical characteristics of the 4.8 kbits/s AMBE algorithm is contained in AMBE-ATC-10 Low Level Description, obtainable from DVSI.

Note 2.— The 4.8 kbits/s AMBE encoding/decoding technology described in the document is subject to DVSI patent rights and copyrights. Manufacturers must enter into a license agreement with DVSI prior to obtaining a detailed description of the algorithm before incorporation in equipment operating in the VDL Mode 3 service. By letter to ICAO dated 29 October 1999, DVSI confirmed its commitment to license the technology for the manufacture and sale of aeronautical equipment under reasonable terms and conditions, negotiated on a non-discriminatory basis.

6.8.2.2 Speech encoding definition, voice unit parameters, and procedure descriptions for VDL Mode 3 Voice Unit operation are contained in the Manual on VDL Mode 3 Technical Specifications.

6.9 VDL MODE 4

6.9.1 A Mode 4 station shall conform to the requirements defined in 6.1.2.3, 6.1.4.2, 6.2.1.1, 6.2.3.1, 6.2.4, 6.3.1, 6.3.3.1, 6.3.4, 6.3.5.1, 6.3.5.2, 6.3.5.3, 6.3.5.4.1 and 6.9.

6.9.2 VDL Mode 4 radio channels

6.9.2.1 VDL MODE 4 STATION FREQUENCY RANGE

6.9.2.1.1 *Transmitter/receiver tuning range.* A VDL Mode 4 transmitter/receiver shall be capable of tuning to any of the 25 kHz channels from 112 MHz to 137 MHz.

Note.— *Operational conditions or certain applications may require the equipment to be operated in a narrower frequency range.*

6.9.2.1.2 *Simultaneous reception.* A VDL Mode 4 station shall be capable of receiving two channels simultaneously.

6.9.2.1.3 **Recommendation.**— *A VDL Mode 4 station should be capable of receiving additional channels simultaneously as required by operational services.*

6.9.2.2 GLOBAL SIGNALLING CHANNELS

6.9.2.2.1 VDL Mode 4 stations shall use two assigned frequencies as global signalling channels (GSC), to support user communications and link management functions.

Note.— *Additional channels may be defined in a local domain and notified to mobile users by broadcast from ground stations on the GSCs defined above.*

6.9.3 System capabilities

6.9.3.1 *ATN compatibility.* The VDL Mode 4 system shall support ATN/IPS-compliant subnetwork services.

Note.— *VDL Mode 4 provides a seamless transfer of data between ATN/IPS ground networks and ATN/IPS aircraft networks. Interoperability with ATN/OSI networks, where required, is expected to be arranged prior to implementation. VDL Modes 2 and 3 provide ATN/OSI-compliant subnetworks.*

6.9.3.2 *Data transparency.* The VDL Mode 4 system shall provide code-independent, byte-independent transfer of data.

6.9.3.3 *Broadcast.* The VDL Mode 4 system shall provide link layer broadcast services.

6.9.3.4 *Point-to-point.* The VDL Mode 4 system shall provide link layer point-to-point services.

6.9.3.5 *Air-air communications.* The VDL Mode 4 system shall provide air-air communications, without ground support, as well as air-ground communications.

6.9.3.6 *Connection management.* When supporting air-ground operations, the VDL Mode 4 system shall establish and maintain a reliable communications path between the aircraft and the ground system while allowing, but not requiring, manual intervention.

6.9.3.7 *Ground network transition.* A mobile VDL Mode 4 DLS station shall transition from one ground VDL Mode 4 DLS station to another as required.

6.9.3.8 *Derived time capability.* VDL Mode 4 shall provide the capability for deriving time from time-of-arrival measurements of received VDL Mode 4 transmissions whenever externally derived estimates of time are unavailable.

6.9.3.9 *Simplex operations.* Mobile and ground VDL Mode 4 stations shall access the physical medium operating in simplex mode.

6.9.4 Coordination of channel utilization

6.9.4.1 On a regional basis, transmissions shall be scheduled relative to UTC, to ensure efficient use of shared channels and to avoid unintentional slot re-use.

6.9.5 Physical layer protocols and services

Note.— Unless otherwise stated, the requirements defined in this section apply to both mobile and ground stations.

6.9.5.1 FUNCTIONS

6.9.5.1.1 TRANSMITTED POWER

6.9.5.1.1.1 *Airborne installation.* The effective radiated power shall be such as to provide a field strength of at least 35 microvolts per metre (minus 114.5 dBW/m²) on the basis of free space propagation, at ranges and altitudes appropriate to the conditions pertaining to the areas over which the aircraft is operated.

6.9.5.1.1.2 *Ground installation.*

Recommendation.— *The effective radiated power should be such as to provide a field strength of at least 75 microvolts per metre (minus 109 dBW/m²) within the defined operational coverage of the facility, on the basis of free-space propagation.*

6.9.5.1.2 TRANSMITTER AND RECEIVER FREQUENCY CONTROL

6.9.5.1.2.1 The VDL Mode 4 physical layer shall set the transmitter or receiver frequency as commanded by the link management entity (LME). Channel selection time shall be less than 13 ms after the receipt of a command from a VSS user.

6.9.5.1.3 DATA RECEPTION BY RECEIVER

6.9.5.1.3.1 The receiver shall decode input signals and forward them to the higher layers for processing.

6.9.5.1.4 DATA TRANSMISSION BY TRANSMITTER

6.9.5.1.4.1 *Data encoding and transmission.* The physical layer shall encode the data received from the data link layer and transmit it over the RF channel. RF transmission shall take place only when permitted by the MAC.

6.9.5.1.4.2 *Order of transmission.* The transmission shall consist of the following stages in the following order:

- a) transmitter power stabilization;
- b) bit synchronization;

- c) ambiguity resolution and data transmission; and
- d) transmitter decay.

Note.— The definitions of the stages are given in Sections 6.9.5.2.3.1 to 6.9.5.2.3.4.

6.9.5.1.4.3 *Automatic transmitter shutdown.* A VDL Mode 4 station shall automatically shut-down power to any final stage amplifier in the event that output power from that amplifier exceeds -30 dBm for more than 1 second. Reset to an operational mode for the affected amplifier shall require a manual operation.

Note.— This is intended to protect the shared channel resource against so-called “stuck transmitters”.

6.9.5.1.5 NOTIFICATION SERVICES

6.9.5.1.5.1 *Signal quality.* The operational parameters of the equipment shall be monitored at the physical layer. Signal quality analysis shall be performed in the demodulator process and in the receive process.

Note.— Processes that may be evaluated in the demodulator include bit error rate (BER), signal to noise ratio (SNR), and timing jitter. Processes that may be evaluated in the receiver include received signal level and group delay.

6.9.5.1.5.2 *Arrival time.* The arrival time of each received transmission shall be measured with a two-sigma error of 5 microseconds.

6.9.5.1.5.3 **Recommendation.**— The receiver should be capable of measuring the arrival time within a two-sigma error of 1 microsecond.

6.9.5.2 PROTOCOL DEFINITION FOR GFSK

6.9.5.2.1 *Modulation scheme.* The modulation scheme shall be GFSK. The first bit transmitted (in the training sequence) shall be a high tone and the transmitted tone shall be toggled before transmitting a 0 (i.e. non-return to zero inverted encoding).

6.9.5.2.2 *Modulation rate.* Binary ones and binary zeros shall be generated with a modulation index of 0.25 ± 0.03 and a BT product of 0.28 ± 0.03 , producing data transmission at a bit rate of $19\,200$ bits/s ± 50 ppm.

6.9.5.2.3 STAGES OF TRANSMISSION

6.9.5.2.3.1 *Transmitter power stabilization.* The first segment of the training sequence is the transmitter power stabilization, which shall have a duration of 16 symbol periods. The transmitter power level shall be no less than 90 per cent of the steady state power level at the end of the transmitter power stabilization segment.

6.9.5.2.3.2 *Bit synchronization.* The second segment of the training sequence shall be the 24-bit binary sequence 0101 0101 0101 0101 0101, transmitted from left to right immediately before the start of the data segment.

6.9.5.2.3.3 *Ambiguity resolution and data transmission.* The transmission of the first bit of data shall start 40 bit intervals (approximately $2\,083.3$ microseconds) ± 1 microsecond after the nominal start of transmission.

Note 1.— This is referenced to emissions at the output of the antenna.

Note 2.— Ambiguity resolution is performed by the link layer.

6.9.5.2.3.4 *Transmitter decay.* The transmitted power level shall decay at least by 20 dB within 300 microseconds after completing a transmission. The transmitter power level shall be less than -90 dBm within 832 microseconds after completing a transmission.

6.9.5.3 CHANNEL SENSING

6.9.5.3.1 *Estimation of noise floor.* A VDL Mode 4 station shall estimate the noise floor based on power measurements of the channel whenever a valid training sequence has not been detected.

6.9.5.3.2 The algorithm used to estimate the noise floor shall be such that the estimated noise floor shall be lower than the maximum power value measured on the channel over the last minute when the channel is regarded as idle.

Note.— The VDL Mode 4 receiver uses an energy sensing algorithm as one of the means to determine the state of the channel (idle or busy). One algorithm that can be used to estimate the noise floor is described in the Manual on VHF Digital Link (VDL) Mode 4 (Doc 9816).

6.9.5.3.3 *Channel idle to busy detection.* A VDL Mode 4 station shall employ the following means to determine the channel idle to busy transition at the physical layer.

6.9.5.3.3.1 *Detection of a training sequence.* The channel shall be declared busy if a VDL Mode 4 station detects a valid training sequence followed by a frame flag.

6.9.5.3.3.2 *Measurement of channel power.* Regardless of the ability of the demodulator to detect a valid training sequence, a VDL Mode 4 station shall consider the channel busy with at least a 95 per cent probability within 1 ms after on-channel power rises to the equivalent of at least four times the estimated noise floor for at least 0.5 milliseconds.

6.9.5.3.4 CHANNEL BUSY TO IDLE DETECTION

6.9.5.3.4.1 A VDL Mode 4 station shall employ the following means to determine the channel busy to idle transition.

6.9.5.3.4.2 *Measurement of transmission length.* When the training sequence has been detected, the channel busy state shall be held for a period of time at least equal to 5 milliseconds, and subsequently allowed to transition to the idle state based on measurement of channel power.

6.9.5.3.4.3 *Measurement of channel power.* When not otherwise held in the channel busy state, a VDL Mode 4 station shall consider the channel idle with at least a 95 per cent probability if on-channel power falls below the equivalent of twice the estimated noise floor for at least 0.9 milliseconds.

6.9.5.4 RECEIVER/TRANSMITTER INTERACTION

6.9.5.4.1 *Receiver to transmitter turnaround time.* A VDL Mode 4 station shall be capable of beginning the transmission of the transmitter power stabilization sequence within 16 microseconds after terminating the receiver function.

6.9.5.4.2 *Frequency change during transmission.* The phase acceleration of the carrier from the start of the synchronization sequence to the data end flag shall be less than 300 Hz per second.

6.9.5.4.3 *Transmitter to receiver turnaround time.* A VDL Mode 4 station shall be capable of receiving and demodulating with nominal performance an incoming signal within 1 ms after completing a transmission.

Note.— Nominal performance is defined as a bit error rate (BER) of 10^{-4} .

6.9.5.5 PHYSICAL LAYER SYSTEM PARAMETERS

6.9.5.5.1 PARAMETER P1 (MINIMUM TRANSMISSION LENGTH)

6.9.5.5.1.1 A receiver shall be capable of demodulating a transmission of minimum length P1 without degradation of BER.

6.9.5.5.1.2 The value of P1 shall be 19 200 bits.

6.9.5.5.2 PARAMETER P2 (NOMINAL CO-CHANNEL INTERFERENCE PERFORMANCE)

6.9.5.5.2.1 The parameter P2 shall be the nominal co-channel interference at which a receiver shall be capable of demodulating without degradation in BER.

6.9.5.5.2.2 The value of P2 shall be 12 dB.

6.9.5.6 FM BROADCAST INTERFERENCE IMMUNITY
PERFORMANCE FOR VDL MODE 4 RECEIVING SYSTEMS

6.9.5.6.1 A VDL Mode 4 station shall conform to the requirements defined in section 6.3.5.4 when operating in the band 117.975–137 MHz.

6.9.5.6.2 A VDL Mode 4 station shall conform to the requirements defined below when operating in the band 108–117.975 MHz.

6.9.5.6.2.1 The VDL Mode 4 receiving system shall meet the requirements specified in 6.3.5.1 in the presence of two-signal, third-order intermodulation products caused by VHF FM broadcast signals having levels in accordance with the following:

$$2N_1 + N_2 + 72 \leq 0$$

for VHF FM sound broadcasting signals in the range 107.7–108.0 MHz

and

$$2N_1 + N_2 + 3 \left\{ 24 - 20 \log \frac{\Delta f}{0.4} \right\} \leq 0$$

for VHF FM sound broadcasting signals below 107.7 MHz,

where the frequencies of the two VHF FM sound broadcasting signals produce, within the receiver, a two-signal, third-order intermodulation product on the desired VDL Mode 4 frequency.

N_1 and N_2 are the levels (dBm) of the two VHF FM sound broadcasting signals at the VDL Mode 4 receiver input. Neither level shall exceed the desensitization criteria set forth in 6.9.5.6.2.2.

$\Delta f = 108.1 - f_1$, where f_1 is the frequency of N_1 , the VHF FM sound broadcasting signal closer to 108.1 MHz.

Note.— The FM intermodulation immunity requirements are not applied to a VDL Mode 4 channel operating below 108.1 MHz, and hence frequencies below 108.1 MHz are not intended for general assignments.

6.9.5.6.2.2 The VDL Mode 4 receiving system shall not be desensitized in the presence of VHF FM broadcast signals having levels in accordance with Table 6-5.

6.9.6 Link layer

Note.— Details on link layer functions are contained in the Manual on VHF Digital Link (VDL) Mode 4 (Doc 9816).

6.9.7 Subnetwork layer and SNDCF

Note.— Details on subnetwork layer functions and SNDCF are contained in the Manual on VHF Digital Link (VDL) Mode 4 (Doc 9816).

6.9.8 ADS-B applications

Note.— Details on ADS-B application functions are contained in the Manual on VHF Digital Link (VDL) Mode 4 (Doc 9816).

TABLES FOR CHAPTER 6

Table 6-1. Modes 2 and 3 data encoding

X_k	Y_k	Z_k	$\Delta\phi_k$
0	0	0	$0\pi/4$
0	0	1	$1\pi/4$
0	1	1	$2\pi/4$
0	1	0	$3\pi/4$
1	1	0	$4\pi/4$
1	1	1	$5\pi/4$
1	0	1	$6\pi/4$
1	0	0	$7\pi/4$

Table 6-2. Modes 2 and 3 modulation stability

VDL Mode	Aircraft Modulation Stability	Ground Modulation Stability
Mode 2	± 0.0050 per cent	± 0.0050 per cent
Mode 3	± 0.0005 per cent	± 0.0002 per cent

Table 6-3. Scrambler functions

Function	Data in	Data out
scrambling	clean data	scrambled data
descrambling	scrambled data	clean data

Table 6-4. Physical services system parameters

Symbol	Parameter name	Mode 2 value
P1	Minimum transmission length	131071 bits

**Table 6-5. VDL Mode 4 operating on frequencies
between 112.0–117.975 MHz**

Frequency (MHz)	Maximum level of unwanted signal at receiver input (dBm)
88–104	+15
106	+10
107	+5
107.9	0

Note.— The relationship is linear between adjacent points designated by the above frequencies.

FIGURES FOR CHAPTER 6

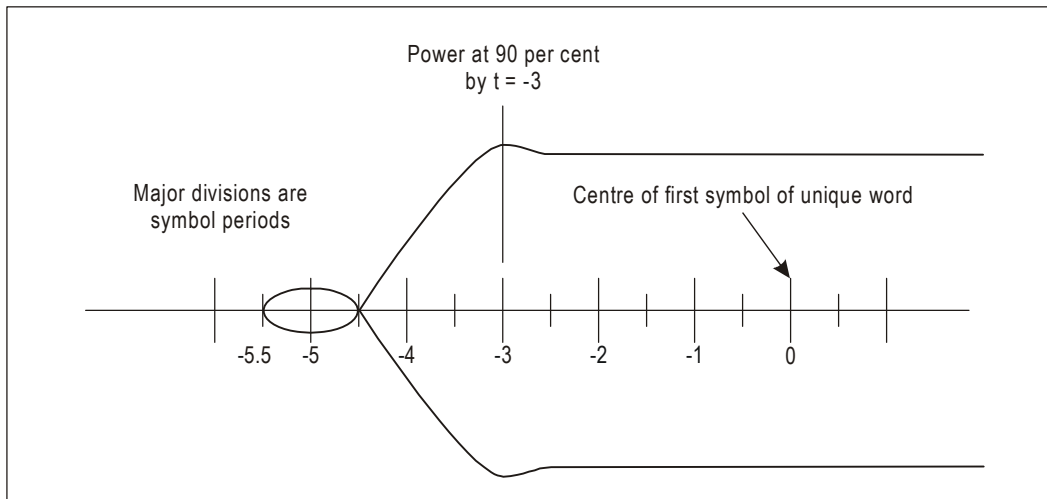

Figure 6-1. Transmitter power stabilization

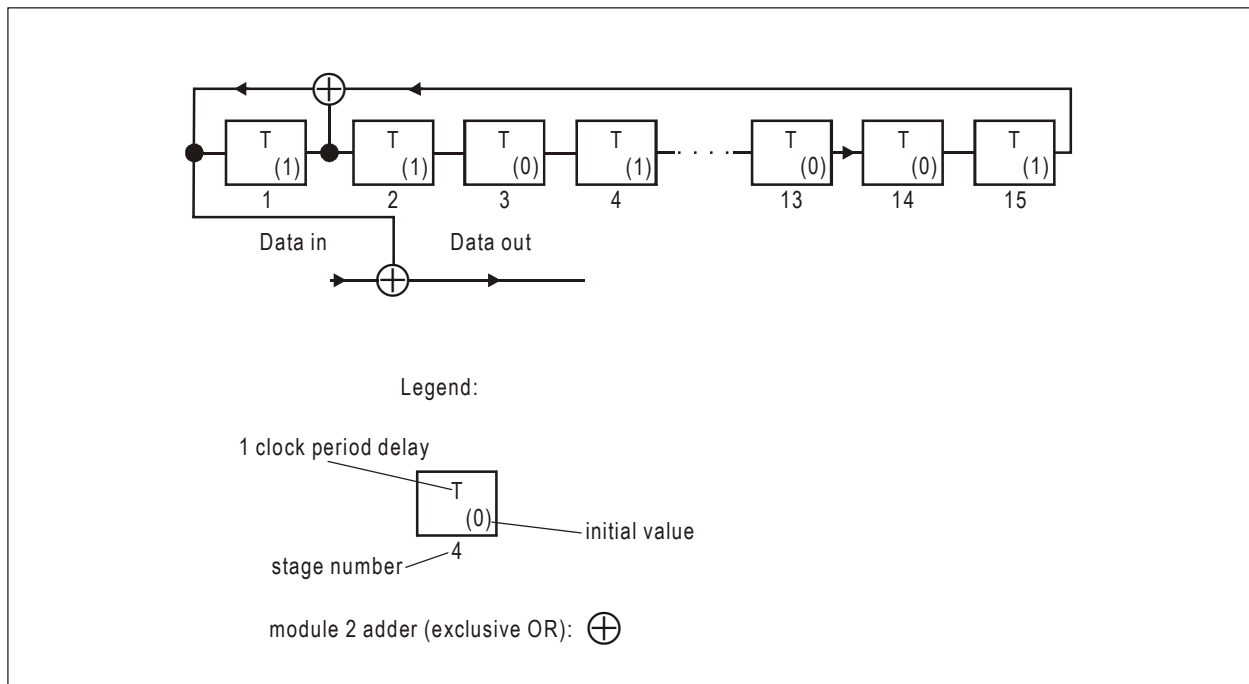

Figure 6-2. PN-generator for bit scrambling sequence

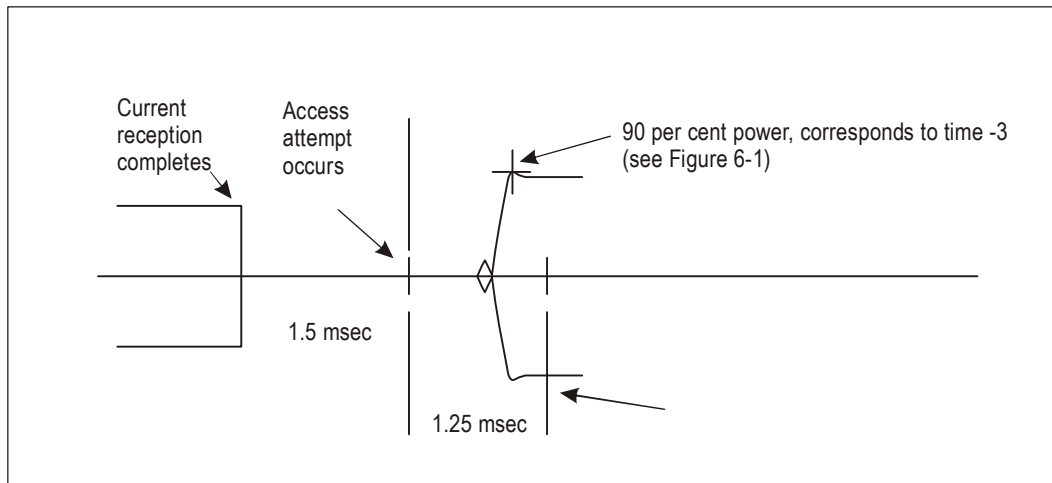

Figure 6-3. Receive to Transmit turnaround time

APPENDIX TO CHAPTER 6 REFERENCES

1. REFERENCES

References to Standards from the International Organization for Standardization (ISO) are as specified (including date published) below. These ISO Standards shall apply to the extent specified in the SARPs.

2. NORMATIVE REFERENCES

These SARPs reference the following ISO documents:

<i>ISO</i>	<i>Title</i>	<i>Date published</i>
646	<i>Information technology — ISO 7-bit coded character set for information interchange</i>	12/91
3309	<i>HDLC Procedures — Frame Structure, Version 3</i>	12/93
4335	<i>HDLC Elements of Procedures, Version 3</i>	12/93
7498	<i>OSI Basic Reference Model, Version 1</i>	11/94
7809	<i>HDLC Procedures — Consolidation of Classes of Procedures, Version 1</i>	12/93
8208	<i>Information Processing Systems — Data Communications — X.25 Packet Level Protocol for Data Terminal Equipment</i>	3/90 2nd ed.
8885	<i>HDLC Procedures — General Purpose XID Frame Information Field Content and Format, Version [1]</i>	12/93
8886.3	<i>OSI Data Link Service Definition, Version 3</i>	6/92
10039	<i>Local Area Networks — MAC Service Definition, Version 1</i>	6/91

3. BACKGROUND REFERENCES

The following documents are listed as reference material.

<i>Originator</i>	<i>Title</i>	<i>Date published</i>
ITU-R	Recommendation S.446.4, Annex I	
CCSDS	<i>Telemetry Channel Coding, Recommendation for Space Data System Standards, Consultative Committee for Space Date Systems, CCSDS 101.0-B-3, Blue Book</i>	5/92

CHAPTER 7. AERONAUTICAL MOBILE AIRPORT COMMUNICATIONS SYSTEM (AEROMACS)

7.1 DEFINITIONS

Adaptive modulation. A system's ability to communicate with another system using multiple burst profiles and a system's ability to subsequently communicate with multiple systems using different burst profiles.

Aerodrome. A defined area on land or water (including any buildings, installations and equipment) intended to be used either wholly or in part for the arrival, departure and surface movement of aircraft.

Aeronautical Mobile Airport Communications System (AeroMACS). A high-capacity data link supporting mobile and fixed communications on the aerodrome surface.

AeroMACS downlink (DL). The transmission direction from the base station (BS) to the mobile station (MS).

AeroMACS uplink (UL). The transmission direction from the mobile station (MS) to the base station (BS).

AeroMACS handover. The process in which a mobile station (MS) migrates from the air-interface provided by one base station (BS) to the air-interface provided by another BS. A break-before-make AeroMACS handover is where service with the target BS starts after a disconnection of service with the previous serving BS.

Base station (BS). A generalized equipment set providing connectivity, management and control of the mobile station (MS).

Bit error rate (BER). The number of bit errors in a sample divided by the total number of bits in the sample, generally averaged over many such samples.

Burst profile. Set of parameters that describe the uplink or downlink transmission properties associated with an interval usage code. Each profile contains parameters such as modulation type, forward error correction (FEC) type, preamble length, guard times, etc.

Convolutional turbo codes (CTC). Type of forward error correction (FEC) code.

Data transit delay. In accordance with ISO 8348, the average value of the statistical distribution of data delays. This delay represents the subnetwork delay and does not include the connection establishment delay.

Domain. A set of end systems and intermediate systems that operate according to the same routing procedures and that is wholly contained within a single administrative domain.

Forward error correction. The process of adding redundant information to the transmitted signal in a manner which allows correction, at the receiver, of errors incurred in the transmission.

Frequency assignment. A logical assignment of centre frequency and channel bandwidth programmed to the base station (BS).

Mobile station (MS). A station in the mobile service intended to be used while in motion or during halts at unspecified points. An MS is always a subscriber station (SS).

Partial usage sub-channelization (PUSC). A technique in which the orthogonal frequency division multiplexing (OFDM) symbol subcarriers are divided and permuted among a subset of sub-channels for transmission, providing partial frequency diversity.

Residual error rate. The ratio of incorrect, lost and duplicate subnetwork service data units (SNSDUs) to the total number of SNSDUs that were sent.

Service data unit (SDU). A unit of data transferred between adjacent layer entities, which is encapsulated within a protocol data unit (PDU) for transfer to a peer layer.

Service flow. A unidirectional flow of media access control layer (MAC) service data units (SDUs) on a connection that is providing a particular quality of service (QoS).

Subscriber station (SS). A generalized equipment set providing connectivity between subscriber equipment and a base station (BS).

Subnetwork entry time. The time from when the mobile station starts the scanning for BS transmission, until the network link establishes the connection, and the first network user “protocol data unit” can be sent.

Subnetwork service data unit (SNSDU). An amount of subnetwork user data, the identity of which is preserved from one end of a subnetwork connection to the other.

Time division duplex (TDD). A duplex scheme where uplink and downlink transmissions occur at different times but may share the same frequency.

7.2 INTRODUCTION

Note 1.— Aeronautical mobile airport communications system (AeroMACS) is a high-capacity data link supporting mobile and fixed communications, related to the safety and regularity of flight, on the aerodrome surface.

Note 2.— AeroMACS is derived from the IEEE 802.16-2009 mobile standards. AeroMACS profile document (RTCA DO345 and EUROCAE ED 222) lists all features from these standards which are mandatory, not applicable or optional. AeroMACS profile differentiates between base station and mobile station functionality and contains, for each feature, a reference to the applicable standards.

7.3 GENERAL

- 7.3.1 AeroMACS shall conform to the requirements of this and the following chapters.
- 7.3.2 AeroMACS shall only transmit when on the surface of an aerodrome.
- 7.3.3 AeroMACS shall support aeronautical mobile (route) service (AM(R) S) communications.
- 7.3.4 AeroMACS shall process messages according to their associated priority.
- 7.3.5 AeroMACS shall support multiple levels of message priority.
- 7.3.6 AeroMACS shall support point to point communication.

7.3.7 AeroMACS shall support multicast and broadcast communication services.

7.3.8 AeroMACS shall support internet protocol (IP) packet data services.

7.3.9 AeroMACS shall provide mechanisms to transport ATN/IPS and ATN/OSI (over IP) based messaging.

7.3.10 **Recommendation.**— *AeroMACS should support voice services.*

Note.— *The Manual on the Aeronautical Telecommunication Network (ATN) using Internet Protocol Suite (IPS) Standards and Protocols (Doc 9896) provides information on voice service over IP.*

7.3.11 AeroMACS shall support multiple service flows simultaneously.

7.3.12 AeroMACS shall support adaptive modulation and coding.

7.3.13 AeroMACS shall support handover between different AeroMACS BSs during aircraft movement or on degradation of connection with current BS.

7.3.14 AeroMACS shall keep total accumulated interference levels with limits defined by the International Telecommunication Union — Radiocommunication Sector (ITU-R) as required by national/international rules on frequency assignment planning and implementation.

7.3.15 AeroMACS shall support a flexible implementation architecture to permit link and network layer functions to be located in different or same physical entities.

7.4 RADIO FREQUENCY (RF) CHARACTERISTICS

7.4.1 General radio characteristics

7.4.1.1 AeroMACS shall operate in time division duplex (TDD) mode.

7.4.1.2 AeroMACS shall operate with a 5 MHz channel bandwidth.

7.4.1.3 AeroMACS MS antenna polarization shall be vertical.

7.4.1.4 AeroMACS BS antenna polarization shall have a vertical component.

7.4.1.5 AeroMACS shall operate without guard bands between adjacent AeroMACS channels.

7.4.1.6 AeroMACS shall operate according to the orthogonal frequency division multiple access method.

7.4.1.7 AeroMACS shall support both segmented partial usage sub-channelization (PUSC) and PUSC with all carriers as subcarrier permutation methods.

7.4.2 Frequency bands

7.4.2.1 AeroMACS equipment shall operate in the band from 5 030 MHz to 5 150 MHz in channels of 5 MHz bandwidth.

Note 1.— Some States may, on the basis of national regulations, have additional allocations to support AeroMACS. Information on the technical characteristics and operational performance of AeroMACS is contained in the AeroMACS Minimum Operational Performance Specification (MOPS) (EUROCAE ED-223 / RTCA DO-346) and AeroMACS Minimum Aviation System Performance Standard (MASPS) (EUROCAE ED-227).

Note 2.— The last centre frequency of 5 145 MHz is selected as the reference frequency for the numbering of AeroMACS channels. AeroMACS nominal centre frequencies are numbered downward from the reference frequency in 5 MHz steps.

7.4.2.2 The mobile equipment shall operate at centre frequencies offset from the preferred frequencies, with an offset of 250 kHz step size.

Note.— The nominal centre frequencies are the preferred centre frequencies for AeroMACS operations. However, the base stations should have the capability to deviate from the preferred centre frequencies to satisfy potential national spectrum authority implementation issues (i.e. to allow AeroMACS operations without receiving or causing interference to other systems operating in the band such as MLS and AMT).

7.4.3 Radiated power

7.4.3.1 The maximum mobile station equivalent isotropic radiated power (EIRP) shall not exceed 30 dBm.

7.4.3.2 The maximum base station EIRP in a sector shall not exceed 39.4 dBm.

7.4.3.3 **Recommendation.**— *In order to meet ITU requirements, the total base station EIRP in a sector should be decreased from that peak, considering the antenna characteristics, at elevations above the horizon. Further information is provided in the guidance material.*

Note 1.— EIRP — defined as antenna gain in a specified elevation direction plus the average AeroMACS transmitter power. While the instantaneous peak power from a given transmitter may exceed that level when all of the subcarriers randomly align in phase, when the large number of transmitters assumed in the analysis is taken into account, average power is the appropriate metric.

Note 2.— If a sector contains multiple transmit antennas (e.g., multiple input multiple output (MIMO) antenna), the specified power limit is the sum of the powers from each antenna.

7.4.4 Minimum receiver sensitivity

7.4.4.1 AeroMACS receiver sensitivity shall comply with Table 7-1, AeroMACS receiver sensitivity values.

Note 1.— The computation of the sensitivity level for AeroMACS is described in the Aeronautical Mobile Airport Communications System (AeroMACS) Manual (Doc 10044).

Note 2.— AeroMACS receiver would be 2 dB more sensitive than indicated if Convolutional Turbo Codes (CTC) is used.

Note 3.— The sensitivity level is defined as the power level measured at the receiver input when the bit error rate (BER) is equal to 1×10^{-6} and all active subcarriers are transmitted in the channel. In general, the requisite input power depends on the number of active subcarriers of the transmission.

Note 4.— The values in Table 7-1 assume a receiver noise figure of 8 dB.

Note 5.— The sensitivity values in Table 7-1 assume absence of any source of interference except for thermal and receiver noise.

Table 7-1. AeroMACS receiver sensitivity values

Modulation scheme using convolutional codes (CC) and encoding scheme	Rep. Factor	MS Sensitivity	BS Sensitivity
64 QAM 3/4	1	-74.3 dBm	-74.5 dBm
64 QAM 2/3	1	-76.3 dBm	-76.5 dBm
16 QAM 3/4	1	-80.3 dBm	-80.5 dBm
16 QAM 1/2	1	-83.8 dBm	-84.0 dBm
QPSK 3/4	1	-86.3 dBm	-86.5 dBm
QPSK 1/2	1	-89.3 dBm	-89.5 dBm
QPSK 1/2 with repetition 2	2	-92.3 dBm	-92.5 dBm

Note.— A 64 QAM transmission is optional for MS.

7.4.5 Spectral mask and emissions

7.4.5.1 The power spectral density of the emissions when all active subcarriers are transmitted in the channel shall be attenuated below the maximum power spectral density as follows:

- a) on any frequency removed from the assigned frequency between 50 and 55 per cent of the authorized bandwidth: $26 + 145 \log(\text{per cent of BW}/50)$ dB;
- b) on any frequency removed from the assigned frequency between 55 and 100 per cent of the authorized bandwidth: $32 + 31 \log(\text{per cent of (BW)}/55)$ dB;
- c) on any frequency removed from the assigned frequency between 100 and 150 per cent of the authorized bandwidth: $40 + 57 \log(\text{per cent of (BW)}/100)$ dB; and
- d) on any frequency removed from the assigned frequency beyond 150 per cent of the authorized bandwidth: 50 dB.

Note.— The power spectral density at a given frequency is the power within a bandwidth equal to 100 kHz centred at this frequency, divided by this measurement bandwidth. It is made clear that the measurement of the power spectral density should encompass the energy over at least one frame period.

7.4.5.2 AeroMACS shall implement power control.

7.4.5.3 AeroMACS minimum rejection for adjacent (± 5 MHz) channel, measured at $\text{BER}=10^{-6}$ level for a victim signal power 3 dB higher than the receiver sensitivity, shall be 10 dB for 16 QAM 3/4.

7.4.5.4 AeroMACS minimum rejection for adjacent (± 5 MHz) channel, measured at $\text{BER}=10^{-6}$ level for a victim signal power 3 dB higher than the receiver sensitivity, shall be 4 dB for 64 QAM 3/4.

7.4.5.5 AeroMACS minimum rejection for second adjacent (± 10 MHz) channel and beyond, measured at $\text{BER}=10^{-6}$ level for a victim signal power 3 dB higher than the receiver sensitivity, shall be 29 dB for 16 QAM 3/4.

7.4.5.6 AeroMACS minimum rejection for second adjacent (± 10 MHz) channel and beyond, measured at BER= 10^{-6} level for a victim signal power 3 dB higher than the receiver sensitivity, shall be 23 dB for 64 QAM 3/4.

Note.— For additional clarification to the requirements stated in 7.4.5.3, 7.4.5.4, 7.4.5.5 and 7.4.5.6, refer to IEEE 802.16-2009 section 8.4.14.2.

7.4.6 Frequency tolerance

7.4.6.1 AeroMACS BS transmitter frequency tolerance shall be better than $\pm 2 \times 10^{-6}$ of nominal channel frequency.

7.4.6.2 AeroMACS MS transmitter centre frequency shall be locked to that of the BS transmission centre frequency with a tolerance better than 2 per cent of the subcarrier spacing.

7.4.6.3 AeroMACS MS shall track the frequency of the BS and shall defer any transmission if synchronization is lost or exceeds the tolerances given above.

7.5 PERFORMANCE REQUIREMENTS

7.5.1 AeroMACS communications service provider

7.5.1.1 The maximum unplanned service outage duration on a per aerodrome basis shall be 6 minutes.

7.5.1.2 The maximum accumulated unplanned service outage time on a per aerodrome basis shall be 240 minutes/year.

7.5.1.3 The maximum number of unplanned service outages shall not exceed 40 per year per aerodrome.

Note.— The requirements given in 7.5.1.1 to 7.5.1.3 refer to the overall service provision by the AeroMACS communication service provider on the aerodrome surface. This may include other media which can provide alternate communication paths in the event of an AeroMACS failure.

7.5.1.4 Connection resilience. The probability that a transaction will be completed once started shall be at least 0.999 for AeroMACS over any one-hour interval.

Note.— Connection releases resulting from AeroMACS handover between base stations, log-off or circuit pre-emption are excluded from this specification.

7.5.2 Doppler shift

7.5.2.1 AeroMACS shall operate with a Doppler shift induced by the movement of the MS up to a radial speed of 92.6 km (50 NM) per hour, relative to the BS.

7.5.3 Delay

7.5.3.1 Subnetwork entry time shall be less than 90 seconds.

7.5.3.2 **Recommendation.**— Subnetwork entry time should be less than 20 seconds.

7.5.3.3 The from-MS data transit delay (95th percentile) for the highest priority data service, shall be less than or equal to 1.4 seconds over a window of 1 hour or 600 SDUs, whichever is longer.

7.5.3.4 The to-MS data transit delay (95th percentile) for the highest priority data service, shall be less than or equal to 1.4 seconds over a window of 1 hour or 600 SDUs, whichever is longer.

7.5.4 Integrity

7.5.4.1 AeroMACS BS and MS shall support mechanisms to detect and correct corrupt SNSDUs.

7.5.4.2 AeroMACS BS and MS shall only process SNSDUs addressed to themselves.

7.5.4.3 **Recommendation.**— *The residual error rate, to/from MS should be less than or equal to 5×10^{-8} per SNSDU.*

Note.— *There are no integrity requirements for SNSDU residual rate to the BS and MS as the requirement is entirely satisfied by the end-to-end systems in the aircraft and air traffic service provider.*

7.5.4.4 The maximum bit error rate shall not exceed 10^{-6} after CTC-FEC, if the received signal is equal to or greater than the minimum sensitivity level for the modulations scheme used, as given in Table 7-1.

7.5.5 Security

7.5.5.1 AeroMACS shall provide a capability to protect the integrity of messages in transit.

Note.— *The capability includes cryptographic mechanisms to provide integrity of messages in transit.*

7.5.5.2 AeroMACS shall provide a capability to protect the availability of the system.

Note.— *The capability includes measures to ensure that the system and its capacity are available for authorized uses during unauthorized events.*

7.5.5.3 AeroMACS shall provide a capability to protect the confidentiality of messages in transit.

Note.— *The capability includes cryptographic mechanisms to provide encryption/decryption of messages.*

7.5.5.4 AeroMACS shall provide an authentication capability.

Note.— *The capability includes cryptographic mechanisms to provide peer entity authentication, mutual peer entity authentication, and data origin authentication.*

7.5.5.5 AeroMACS shall provide a capability to ensure the authenticity of messages in transit.

Note.— *The capability includes cryptographic mechanisms to provide authenticity of messages in transit.*

7.5.5.6 AeroMACS shall provide a capability to authorize the permitted actions of users of the system.

Note.— *The capability includes mechanisms to explicitly authorize the actions of authenticated users. Actions that are not explicitly authorized are denied.*

7.5.5.7 If AeroMACS provide interfaces to multiple domains, AeroMACS shall provide capability to prevent intrusion from lower integrity domain to higher integrity domain.

7.6 SYSTEM INTERFACES

7.6.1 AeroMACS shall provide data service interface to the system users.

7.6.2 AeroMACS shall support notification of the status of communications.

Note.— This requirement could support notification of the loss of communications (such as join and leave events).

7.7 APPLICATION REQUIREMENTS

7.7.1 AeroMACS shall support multiple classes of services to provide appropriate service levels to applications.

7.7.2 If there is a resource contention, AeroMACS shall pre-empt services with a lower priority than those given in Annex 10, Volume II, 5.1.8

CHAPTER 8. AFTN NETWORK

8.1 DEFINITIONS

Data signalling rate. Data signalling rate refers to the passage of information per unit of time, and is expressed in bits/second. Data signalling rate is given by the formula:

$$\sum_{i=1}^{i=m} \frac{1}{T_i} \log_2 n_i$$

where m is the number of parallel channels, T_i is the minimum interval for the i th channel expressed in seconds, n_i is the number of significant conditions of the modulation in the i th channel.

Note 1.—

- a) For a single channel (serial transmission) it reduces to $(1/T)\log_2 n$; with a two-condition modulation ($n = 2$), it is $1/T$.
- b) For a parallel transmission with equal minimum intervals and equal number of significant conditions on each channel, it is $m(1/T)\log_2 n$ ($m(1/T)$ in case of a two-condition modulation).

Note 2.— In the above definition, the term “parallel channels” is interpreted to mean: channels, each of which carries an integral part of an information unit, e.g. the parallel transmission of bits forming a character. In the case of a circuit comprising a number of channels, each of which carries information “independently”, with the sole purpose of increasing the traffic handling capacity, these channels are not to be regarded as parallel channels in the context of this definition.

Degree of standardized test distortion. The degree of distortion of the restitution measured during a specific period of time when the modulation is perfect and corresponds to a specific text.

Effective margin. That margin of an individual apparatus which could be measured under actual operating conditions.

Low modulation rates. Modulation rates up to and including 300 bauds.

Margin. The maximum degree of distortion of the circuit at the end of which the apparatus is situated which is compatible with the correct translation of all the signals which it may possibly receive.

Medium modulation rates. Modulation rates above 300 and up to and including 3 000 bauds.

Modulation rate. The reciprocal of the unit interval measured in seconds. This rate is expressed in bauds.

Note.— Telegraph signals are characterized by intervals of time of duration equal to or longer than the shortest or unit interval. The modulation rate (formerly telegraph speed) is therefore expressed as the inverse of the value of this unit interval. If, for example, the unit interval is 20 milliseconds, the modulation rate is 50 bauds.

Synchronous operation. Operation in which the time interval between code units is a constant.

8.2 TECHNICAL PROVISIONS RELATING TO TELETYPEWRITER APPARATUS AND CIRCUITS USED IN THE AFTN

8.2.1 In international teletypewriter circuits of the AFTN, using a 5-unit code, the International Telegraph Alphabet No. 2 (see Table 8-1*) shall be used only to the extent prescribed in 4.1.2 of Volume II.

8.2.2 **Recommendation.**— *The modulation rate should be determined by bilateral or multilateral agreement between administrations concerned, taking into account primarily traffic volume.*

8.2.3 **Recommendation.**— *The nominal duration of the transmitting cycle should be at least 7.4 units (preferably 7.5), the stop element lasting for at least 1.4 units (preferably 1.5).*

8.2.3.1 **Recommendation.**— *The receiver should be able to translate correctly in service the signals coming from a transmitter with a nominal transmitting cycle of 7 units.*

8.2.4 **Recommendation.**— *Apparatus in service should be maintained and adjusted in such a manner that its net effective margin is never less than 35 per cent.*

8.2.5 **Recommendation.**— *The number of characters which the textual line of the page-printing apparatus may contain should be fixed at 69.*

8.2.6 **Recommendation.**— *In start-stop apparatus fitted with automatic time delay switches, the disconnection of the power supply to the motor should not take place before the lapse of at least 45 seconds after the reception of the last signal.*

8.2.7 **Recommendation.**— *Arrangements should be made to avoid the mutilation of signals transmitted at the head of a message and received on start-stop reperforating apparatus.*

8.2.7.1 **Recommendation.**— *If the reperforating apparatus is provided with local means for feeding the paper, not more than one mutilated signal should be tolerated.*

8.2.8 **Recommendation.**— *Complete circuits should be so engineered and maintained that their degree of standardized test distortion does not exceed 28 per cent on the standardized text:*

THE QUICK BROWN FOX JUMPS
OVER THE LAZY DOG

or

VOYEZ LE BRICK GEANT QUE
JEXAMINE PRES DU WHARF

8.2.9 **Recommendation.**— *The degree of isochronous distortion on the standardized text of each of the parts of a complete circuit should be as low as possible, and in any case should not exceed 10 per cent.*

8.2.10 **Recommendation.**— *The overall distortion in transmitting equipment used on teletypewriter channels should not exceed 5 per cent.*

8.2.11 **Recommendation.**— *AFTN circuits should be equipped with a system of continuous check of channel condition. Additionally, controlled circuit protocols should be applied.*

* All tables and figures are located at the end of this chapter.

**8.3 TERMINAL EQUIPMENT ASSOCIATED
WITH AERONAUTICAL RADIOTELETYPEWRITER
CHANNELS OPERATING IN THE BAND
2.5 – 30 MHz**

8.3.1 Selection of type of modulation and code

8.3.1.1 **Recommendation.**— *Frequency shift modulation (FIB) should be employed in radioteletypewriter systems used in the aeronautical fixed service (AFS), except where the characteristics of the independent sideband (ISB) method of operation are of advantage.*

Note.— *FIB type of modulation is accomplished by shifting a radio frequency carrier between two frequencies representing “position A” (start signal polarity) and “position Z” (stop signal polarity) of the start-stop 5-unit telegraphic code.*

8.3.2 System characteristics

8.3.2.1 **Recommendation.**— *The characteristics of signals from radioteletypewriter transmitters utilizing FIB modulation should be as follows:*

- a) *Frequency shift: the lowest possible value.*
- b) *Frequency shift tolerance: within plus or minus 3 per cent of the nominal value of the frequency shift.*
- c) *Polarity: single channel circuits: the higher frequency corresponds to “position A” (start signal polarity).*

8.3.2.2 **Recommendation.**— *The variation of the mean between the radio frequencies representing respectively “position A” and “position Z” should not exceed 100 Hz during any two-hour period.*

8.3.2.3 **Recommendation.**— *The overall distortion of the teletypewriter signal, as monitored at the output of the radio transmitter or in its immediate vicinity, should not exceed 10 per cent.*

Note.— *Such distortion means the displacement in time of the transitions between elements from their proper positions, expressed as a percentage of unit element time.*

8.3.2.4 **Recommendation.**— *Radioteletypewriter receivers concerned with FIB modulation should be capable of operating satisfactorily on signals having the characteristics set out in 8.3.2.1 and 8.3.2.2.*

8.3.2.5 **Recommendation.**— *The characteristics of multichannel transmission of teletypewriter signals over a radio circuit should be established by agreement between the Administrations concerned.*

8.4 CHARACTERISTICS OF INTERREGIONAL AFS CIRCUITS

8.4.1 **Recommendation.**— *Interregional AFS circuits being implemented or upgraded should employ high quality telecommunications service. Modulation rate should take into account traffic volumes expected under both normal and alternate route conditions.*

8.5 TECHNICAL PROVISIONS RELATING TO ATS MESSAGE TRANSMISSION

8.5.1 *Interconnection by direct or omnibus channels — low modulation rates — 5-unit code.*

Note.— See 8.6 for medium modulation rates.

8.5.1.1 **Recommendation.**— *AFTN techniques (cf. 8.2) should be used.*

8.6 TECHNICAL PROVISIONS RELATING TO INTERNATIONAL GROUND-GROUND DATA INTERCHANGE AT MEDIUM AND HIGHER SIGNALLING RATES

Note.— Throughout this section in the context of coded character sets, the term “unit” means the unit of selective information and is essentially equivalent to the term “bit”.

8.6.1 General

8.6.1.1 **Recommendation.**— *In international data interchange of characters, a 7-unit coded character set providing a repertoire of 128 characters and designated as International Alphabet No. 5 (IA-5) should be used. Compatibility with the 5-unit coded character set of International Telegraph Alphabet No. 2 (ITA-2) should be ensured where applicable.*

8.6.1.2 When the provisions of 8.6.1.1 are applied, International Alphabet No. 5 (IA-5) contained in Table 8-2 shall be used.

8.6.1.2.1 The serial transmission of units comprising an individual character of IA-5 shall be with the low order unit (b_1) transmitted first.

8.6.1.2.2 **Recommendation.**— *When IA-5 is used, each character should include an additional unit for parity in the eighth level position.*

8.6.1.2.3 When the provisions of 8.6.1.2.2 are applied, the sense of the character parity bit shall produce even parity in links which operate on the start-stop principle, and odd parity in links using end-to-end synchronous operations.

8.6.1.2.4 Character-for-character conversion shall be as listed in Tables 8-3 and 8-4 for all characters which are authorized in the AFTN format for transmission on the AFS in both IA-5 and ITA-2.

8.6.1.2.5 Characters which appear in only one code set, or which are not authorized for transmission on the AFS shall be as depicted in the code conversion tables.

8.6.2 Data transmission characteristics

8.6.2.1 **Recommendation.**— *The data signalling rate should be chosen from among the following:*

<i>600 bits/s</i>	<i>4 800 bits/s</i>
<i>1 200 bits/s</i>	<i>9 600 bits/s</i>
<i>2 400 bits/s</i>	

8.6.2.2 **Recommendation.**— *The type of transmission for each data signalling rate should be chosen as follows:*

Data signalling rate	Type of transmission
600 bits/s	<i>Synchronous or asynchronous serial transmission</i>
1 200 bits/s	<i>Synchronous or asynchronous serial transmission</i>
2 400 bits/s	<i>Synchronous serial transmission</i>
4 800 bits/s	<i>Synchronous serial transmission</i>
9 600 bits/s	<i>Synchronous serial transmission</i>

8.6.2.3 **Recommendation.**— *The type of modulation for each data signalling rate should be chosen as follows:*

Data signalling rate	Type of modulation
600 bits/s	<i>Frequency</i>
1 200 bits/s	<i>Frequency</i>
2 400 bits/s	<i>Phase</i>
4 800 bits/s	<i>Phase</i>
9 600 bits/s	<i>Phase-amplitude</i>

Note.— *This recommendation does not necessarily apply to ground-ground extensions of air-ground links used exclusively for the transfer of air-ground data, inasmuch as such circuits may be considered as part of the air-ground link.*

8.6.2.4 CHARACTER STRUCTURE ON DATA LINKS

8.6.2.4.1 Character parity shall not be used for error checking on CIDIN links. Parity appended to IA-5 coded characters per 8.6.1.2.2, prior to entry to the CIDIN shall be ignored. For messages exiting the CIDIN, parity shall be generated in accordance with 8.6.1.2.3.

8.6.2.4.2 Characters of less than eight bits in length shall be padded out to eight bits in length before transmission over any octet-based or bit-oriented communications network. The padding bits shall occupy the higher order end of the octet, i.e. bit 8, bit 7 as required, and shall have the binary values 0.

8.6.2.5 When exchanging data over CIDIN links using bit-oriented procedures, the entry centre address, exit centre addresses and destination addresses in the Transport and CIDIN Packet Headers shall be in the IA-5 character set contained in Table 8-2.

8.6.2.6 **Recommendation.**— *When transmitting messages in AFTN format over CIDIN links using bit-oriented procedures, the messages should be in the IA-5 character set contained in Table 8-2.*

8.6.3 Ground-ground character-oriented data link control procedures

Note.— *The provisions of this section pertain to ground-ground data interchange applications using IA-5 prescribed by 8.6.1 and which employ the ten transmission control characters (SOH, STX, ETX, EOT, ENQ, ACK, DLE, NAK, SYN, and ETB) for data link control, over synchronous or asynchronous transmission facilities.*

8.6.3.1 *Descriptions.* The following descriptions shall apply to data link applications contained in this section:

- a) A master station is that station which has control of the data link at a given instant.
- b) A slave station is one that has been selected to receive a transmission from the master station.
- c) A control station is the single station on a multipoint link that is permitted to assume master status and deliver messages to one or more individually selected (non-control) tributary stations, or it is permitted to assign temporary master status to any of the other tributary stations.

8.6.3.2 MESSAGE COMPOSITION

- a) A transmission shall consist of characters from IA-5 transmitted in accordance with 8.6.1.2.2 and shall be either an information message or a supervisory sequence.
- b) An information message used for the exchange of data shall take one of the following forms:

- | | | | | | | |
|----|---|---------------|---|------------|---|---|
| 1) | S | | E | B | | |
| | T | ---TEXT--- | T | C | | |
| | X | | X | C | | |
| | | | | | | |
| 2) | S | | E | B | | |
| | T | ---TEXT--- | T | C | | |
| | X | | B | C | | |
| | | | | | | |
| 3) | S | | S | E | B | |
| | O | ---HEADING--- | T | ---TEXT--- | T | C |
| | H | | X | | X | C |
| | | | | | | |
| 4) | S | | S | E | B | |
| | O | ---HEADING--- | T | ---TEXT--- | T | C |
| | H | | X | | B | C |
| | | | | | | |
| 5) | S | | E | B | | |
| | O | ---HEADING--- | T | C | | |
| | H | | B | C | | |

Note 1.— *B*
C is a block check character (BCC).

Note 2.— *In formats 2), 4), and 5) above which end with ETB, some continuation is required.*

- c) A supervisory sequence shall be composed of either a single transmission control character (EOT, ENQ, ACK or NAK) or a single transmission control (ENQ) preceded by a prefix of up to 15 non-control characters, or the character DLE used in conjunction with other graphic and control characters to provide additional communication control functions.

8.6.3.3 Three system categories are specified in terms of their respective circuit characteristics, terminal configurations, and message transfer procedures as follows:

System category A: two-way alternate, multipoint allowing either centralized or non-centralized operation and single or multiple message-oriented information transfers without replies (but with delivery verification).

System category B: two-way simultaneous, point-to-point employing message associated blocking and modulo 8 numbering of blocks and acknowledgements.

System category C: two-way alternate, multipoint allowing only centralized (computer-to-terminal) operation, single or multiple message transfers with replies.

8.6.3.3.1 In addition to the characteristics prescribed in the paragraphs that follow for both system categories A and B, other parameters that shall be accounted for in order to ensure viable, operationally reliable communications include:

- a) the number of SYN characters required to establish and maintain synchronization;

Note.— Normally the transmitting station sends three contiguous SYN characters and the receiving station detects at least two before any action is taken.

- b) the values of system time-outs for such functions as “idle line” and “no response” as well as the number of automatic retries that are to be attempted before manual intervention is signalled;
- c) the composition of prefixes within a 15 character maximum.

Note.— By agreement between the administrations concerned, it is permissible for supervisory signals to contain a station identification prefix using characters selected from columns 4 through 7 of IA-5.

8.6.3.3.2 **Recommendation.**— *For multipoint implementations designed to permit only centralized (computer-to-terminal) operations, the provisions of 8.6.3.7 should be employed.*

8.6.3.4 BLOCK CHECK CHARACTER

8.6.3.4.1 Both system category A and B shall utilize a block check character to determine the validity of a transmission.

8.6.3.4.2 The block check character shall be composed of 7 bits plus a parity bit.

8.6.3.4.3 Each of the first 7 bits of the block check character shall be the modulo 2 binary sum of every element in the same bit 1 to bit 7 column of the successive characters of the transmitted block.

8.6.3.4.4 The longitudinal parity of each column of the block, including the block check character, shall be even.

8.6.3.4.5 The sense of the parity bit of the block check character shall be the same as for the information characters (see 8.6.1.2.3).

8.6.3.4.6 SUMMATION

8.6.3.4.6.1 The summation to obtain the block check character shall be started by the first appearance of either SOH (start of heading) or STX (start of text).

8.6.3.4.6.2 The starting character shall not be included in the summation.

8.6.3.4.6.3 If an STX character appears after the summation has been started by SOH, then the STX character shall be included in the summation as if it were a text character.

8.6.3.4.6.4 With the exception of SYN (synchronous idle), all the characters which are transmitted after the start of the block check summation shall be included in the summation, including the ETB (end of transmission/block) or ETX (end of text) control character which signals that the following character is the block check character.

8.6.3.4.7 No character, SYN or otherwise, shall be inserted between the ETB or ETX character and the block check character.

8.6.3.5 DESCRIPTION OF SYSTEM CATEGORY A

System category A is one in which a number of stations are connected by a multipoint link and one station is permanently designated as the control station which monitors the link at all times to ensure orderly operation.

8.6.3.5.1 LINK ESTABLISHMENT PROCEDURE

8.6.3.5.1.1 To establish the link for transmission, the control station shall either:

- a) poll one of the tributary stations to assign it master status; or
- b) assume master status and select one or more tributary (slave) stations to receive a transmission.

8.6.3.5.1.2 Polling shall be accomplished by the control station sending a polling supervisory sequence consisting of a prefix identifying a single tributary station and ending in ENQ.

8.6.3.5.1.3 A tributary station detecting its assigned polling supervisory sequence shall assume master status and respond in one of two ways:

- a) if the station has a message to send, it shall initiate a selection supervisory sequence as described in 8.6.3.5.1.5;
- b) if the station has no message to send, it shall send EOT, and master status shall revert to the control station.

8.6.3.5.1.4 If the control station detects an invalid or no response resulting from a poll, it shall terminate by sending EOT prior to resuming polling or selection.

8.6.3.5.1.5 Selection shall be accomplished by the designated master station sending a selection supervisory sequence consisting of a prefix identifying a single station and ending in ENQ.

8.6.3.5.1.6 A station detecting its assigned selection supervisory sequence shall assume slave status and send one of two replies:

- a) if the station is ready to receive, it shall send a prefix followed by ACK. Upon detecting this reply, the master station shall either select another station or proceed with message transfer;
- b) if the station is not ready to receive, it shall send a prefix followed by NAK and thereby relinquish slave status. If the master station receives NAK, or no reply, it shall either select another or the same tributary station or terminate;
- c) it shall be permissible for N retries ($N \geq 0$) to be made to select a station for which NAK, an invalid reply, or no response has been received.

8.6.3.5.1.7 If one or more stations have been selected and have properly responded with ACK, the master station shall proceed with message transfer.

8.6.3.5.2 MESSAGE TRANSFER PROCEDURE

8.6.3.5.2.1 The master station shall send a message or series of messages, with or without headings to the selected slave station(s).

8.6.3.5.2.2 The transmission of a message shall:

a) begin with:

- SOH if the message has a heading,
- STX if the message has no heading;

b) be continuous, ending with ETX, immediately followed by a block check character (BCC).

8.6.3.5.2.3 After transmitting one or more messages, the master station shall verify successful delivery at each selected slave station.

8.6.3.5.3 *DELIVERY VERIFICATION PROCEDURE*

8.6.3.5.3.1 The master station shall send a delivery verification supervisory sequence consisting of a prefix identifying a single slave station and ending in ENQ.

8.6.3.5.3.2 A slave station detecting its assigned delivery verification supervisory sequence shall send one of two replies:

- a) if the slave station properly received all of the transmission, it shall send an optional prefix followed by ACK;
- b) if the slave station did not receive all of the transmission properly, it shall send an optional prefix followed by NAK.

8.6.3.5.3.3 If the master station receives no reply or an invalid reply, it shall request a reply from the same or another slave station until all selected stations have been properly accounted for.

8.6.3.5.3.4 If the master station receives a negative reply (NAK) or, after $N \geq 0$ repeat attempts, no reply, it shall repeat that transmission to the appropriate slave stations at a later opportunity.

8.6.3.5.3.5 After all messages have been sent and delivery verified, the master station shall proceed with link termination.

8.6.3.5.4 *LINK TERMINATION PROCEDURE*

8.6.3.5.4.1 The terminate function, negating the master or slave status of all stations and returning master status to the control station, shall be accomplished by the master station transmitting EOT.

8.6.3.6 DESCRIPTION OF SYSTEM CATEGORY B

System category B is one in which two stations are on a point-to-point, full-duplex link and each station has the capability to maintain concurrent master and slave status, i.e. master status on its transmit side and slave status on its receive side and both stations can transmit simultaneously.

8.6.3.6.1 *LINK ESTABLISHMENT PROCEDURE*

8.6.3.6.1.1 To establish the link for message transfers (from the calling to the called station), the calling station shall request the identity of the called station by sending an identification supervisory sequence consisting of a DLE character followed by a colon character, an optional prefix, and ENQ.

8.6.3.6.1.2 The called station, upon detecting ENQ, shall send one of two replies:

- a) if ready to receive, it shall send a sequence consisting of a DLE followed by a colon, a prefix which includes its identity and ended by ACK0 (see 8.6.3.6.2.5). This establishes the link for message transfers from the calling to the called station;
- b) if not ready to receive, it shall send the above sequence with the ACK0 replaced by NAK.

8.6.3.6.1.3 Establishment of the link for message transfers in the opposite direction can be initiated at any time following circuit connection in a similar manner to that described above.

8.6.3.6.2 MESSAGE TRANSFER PROCEDURE

8.6.3.6.2.1 System category B message transfer provides for message associated blocking with longitudinal checking and modulo 8 numbered acknowledgements.

8.6.3.6.2.2 It is permissible for a transmission block to be a complete message or a portion of a message. The sending station shall initiate the transmission with SOTB N followed by:

- a) SOH if it is the beginning of a message that contains a heading;
- b) STX if it is the beginning of a message that has no heading;
- c) SOH if it is an intermediate block that continues a heading;
- d) STX if it is an intermediate block that continues a text.

Note.— SOTB N is the two-character transmission control sequence DLE = (characters 1/0, and 3/13) followed by the block number, N, where N is one of the IA-5 characters 0, 1 ... 7 (characters 3/0, 3/1 ... 3/7).

8.6.3.6.2.3 A block which ends at an intermediate point within a message shall be ended with ETB; a block which ends at the end of a message shall be ended with ETX.

8.6.3.6.2.4 It shall be permissible for each station to initiate and continue to send messages to the other concurrently according to the following sequence.

- a) It shall be permissible for the sending station (master side) to send blocks, containing messages or parts of messages, continuously to the receiving station (slave side) without waiting for a reply.
- b) It shall be permissible for replies, in the form of slave responses, to be transmitted by the receiving station while the sending station is sending subsequent blocks.

Note.— By use of modulo 8 numbering of blocks and replies, it shall be permissible for the sending station to send as many as seven blocks ahead of the received replies before being required to stop transmission until six or less blocks are outstanding.

- c) If a negative reply is received, the sending station (master side) shall start retransmission with the block following the last block for which the proper affirmative acknowledgement was received.

8.6.3.6.2.5 Slave responses shall be according to one of the following:

- a) if a transmission block is received without error and the station is ready to receive another block, it shall send DLE, a colon, an optional prefix, and the appropriate acknowledgement ACKN (referring to the received block beginning

with SOTB N, e.g. ACK0, transmitted as DLE0 is used as the affirmative reply to the block numbered SOTB0, DLE1 for SOTB1, etc.);

- b) if a transmission block is not acceptable, the receiving station shall send DLE, a colon, an optional prefix, and NAK.

8.6.3.6.2.6 **Recommendation.**— *Slave responses should be interleaved between message blocks and transmitted at the earliest possible time.*

8.6.3.6.3 LINK TERMINATION PROCEDURE

8.6.3.6.3.1 If the link has been established for message transfers in either or both directions, the sending of EOT by a station shall signal the end of message transfers in that direction. To resume message transfers after sending EOT, the link shall be re-established in that direction.

8.6.3.6.3.2 EOT shall only be transmitted by a station after all outstanding slave responses have been received or otherwise accounted for.

8.6.3.6.4 CIRCUIT DISCONNECTION

8.6.3.6.4.1 On switched connections, the data links in both directions shall be terminated before the connection is cleared. In addition, the station initiating clearing of the connection shall first announce its intention to do so by transmitting the two-character sequence DLE EOT, followed by any other signals required to clear the connection.

8.6.3.7 DESCRIPTION OF SYSTEM CATEGORY C (CENTRALIZED)

System category C (centralized) is one (like system category A) in which a number of stations are connected by a multipoint link and one station is designated as the control station but (unlike system category A) provides only for centralized (computer-to-terminal) operations where message interchange (with replies) shall be constrained to occur only between the control and a selected tributary station.

8.6.3.7.1 LINK ESTABLISHMENT PROCEDURE

8.6.3.7.1.1 To establish the link for transmission the control station shall either:

- a) poll one of the tributary stations to assign it master status; or
- b) assume master status and select a tributary station to assume slave status and receive a transmission according to either of two prescribed selection procedures:
 - 1) selection with response (see 8.6.3.7.1.5); or
 - 2) fast select (see 8.6.3.7.1.7).

8.6.3.7.1.2 Polling is accomplished by the control station sending a polling supervisory sequence consisting of a prefix identifying a single tributary station and ending in ENQ.

8.6.3.7.1.3 A tributary station detecting its assigned polling supervisory sequence shall assume master status and respond in one of two ways:

- a) if the station has a message to send, it shall initiate message transfer. The control station assumes slave status;
- b) if the station has no message to send, it shall send EOT and master status shall revert to the control station.

8.6.3.7.1.4 If the control station detects an invalid or no response resulting from a poll, it shall terminate by sending EOT prior to resuming polling or selection.

8.6.3.7.1.5 Selection with response is accomplished by the control station assuming master status and sending a selection supervisory sequence consisting of a prefix identifying a single tributary station and ending in ENQ.

8.6.3.7.1.6 A tributary station detecting its assigned selection supervisory sequence shall assume slave status and send one of two replies:

- a) if the station is ready to receive, it shall send an optional prefix followed by ACK. Upon detecting this reply, the master station shall proceed with message transfer;
- b) if the station is not ready to receive, it shall send an optional prefix followed by NAK. Upon detecting NAK, it shall be permissible for the master station to again attempt selecting the same tributary station or initiate termination by sending EOT.

Note.— If the control station receives an invalid or no reply, it is permitted to attempt again to select the same tributary or after N retries ($N \geq 0$) either to exit to a recovery procedure or to initiate termination by sending EOT.

8.6.3.7.1.7 Fast select is accomplished by the control station assuming master status and sending a selection supervisory sequence, and without ending this transmission with ENQ or waiting for the selected tributary to respond, proceeding directly to message transfer.

8.6.3.7.2 MESSAGE TRANSFER PROCEDURE

8.6.3.7.2.1 The station with master status shall send a single message to the station with slave status and wait for a reply.

8.6.3.7.2.2 The message transmission shall:

- a) begin with:
 - SOH if the message has a heading,
 - STX if the message has no heading;

and

- b) be continuous, ending with ETX, immediately followed by BCC.

8.6.3.7.2.3 The slave station, upon detecting ETX followed by BCC, shall send one of two replies:

- a) if the messages were accepted and the slave station is ready to receive another message, it shall send an optional prefix followed by ACK. Upon detecting ACK, the master station shall be permitted either to transmit the next message or initiate termination;
- b) if the message was not accepted and the slave station is ready to receive another message, it shall send an optional prefix followed by NAK. Upon detecting NAK, the master station may either transmit another message or initiate

termination. Following the NAK reply, the next message transmitted need not be a retransmission of the message that was not accepted.

8.6.3.7.2.4 If the master station receives an invalid or no reply to a message, it shall be permitted to send a delivery verification supervisory sequence consisting of an optional prefix followed by ENQ. Upon receipt of a delivery verification supervisory sequence, the slave station repeats its last reply.

8.6.3.7.2.5 N retries ($N \geq 0$) may be made by the master station in order to get a valid slave reply. If a valid reply is not received after N retries, the master station exits to a recovery procedure.

8.6.3.7.3 LINK TERMINATION PROCEDURE

8.6.3.7.3.1 The station with master status shall transmit EOT to indicate that it has no more messages to transmit. EOT shall negate the master/slave status of both stations and return master status to the control station.

8.6.4 Ground-ground bit-oriented data link control procedures

Note.— The provisions of this section pertain to ground-ground data interchange applications using bit-oriented data link control procedures enabling transparent, synchronous transmission that is independent of any encoding; data link control functions are accomplished by interpreting designated bit positions in the transmission envelope of a frame.

8.6.4.1 The following descriptions shall apply to data link applications contained in this section:

- a) Bit-oriented data link control procedures enable transparent transmission that is independent of any encoding.
- b) A data link is the logical association of two interconnected stations, including the communication control capability of the interconnected stations.
- c) A station is a configuration of logical elements, from or to which messages are transmitted on a data link, including those elements which control the message flow on the link via communication control procedures.
- d) A combined station sends and receives both commands and responses and is responsible for control of the data link.
- e) Data communication control procedures are the means used to control and protect the orderly interchange of information between stations on a data link.
- f) A component is defined as a number of bits in a prescribed order within a sequence for the control and supervision of the data link.
- g) An octet is a group of 8 consecutive bits.
- h) A sequence is one or more components in prescribed order comprising an integral number of octets.
- i) A field is a series of a specified number of bits or specified maximum number of bits which performs the functions of data link or communications control or constitutes data to be transferred.
- j) A frame is a unit of data to be transferred over the data link, comprising one or more fields in a prescribed order.
- k) A common ICAO data interchange network (CIDIN) switching centre is that part of an automatic AFTN switching centre which provides for the entry, relay, and exit centre functions using the bit-oriented link and CIDIN network

procedures specified in this section and includes the appropriate interface(s) with other parts of the AFTN and with other networks.

8.6.4.2 BIT-ORIENTED DATA LINK CONTROL PROCEDURES FOR POINT-TO-POINT,
GROUND-GROUND DATA INTERCHANGE APPLICATIONS EMPLOYING
SYNCHRONOUS TRANSMISSION FACILITIES

Note.— The following link level procedures are the same as the LAPB link level procedures described in ITU CCITT Recommendation X.25, Section 2, Yellow Book (1981 version). Later versions of Recommendation X.25 will be reviewed as they are released to ascertain whether or not they should be adopted.

8.6.4.2.1 *Frame format.* Frames shall contain not less than 32 bits, excluding the opening and closing flags, and shall conform to the following format:

FLAG F	ADDRESS A	CONTROL C	INFORMATION I	FCS	FLAG F
-----------	--------------	--------------	------------------	-----	-----------

8.6.4.2.1.1 A frame shall consist of an opening flag (F), an address field (A), a control field (C), an optional information field (I), a frame check sequence (FCS), and a closing flag sequence (F), and shall be transmitted in that order.

Note.— In relation to CIDIN, the opening flag, the fields A and C, the FCS and the closing flag form together the Data Link Control Field (DLCF). The field I is denoted as the Link Data Field (LDF).

8.6.4.2.1.1.1 The flag (F) shall be the 8-bit sequence 01111110 which delimits the beginning and ending of each frame. It shall be permissible for the closing flag of a frame to also serve as the opening flag of the next frame.

8.6.4.2.1.1.2 The address (A) field shall consist of one octet, excluding 0 bits added to achieve transparent transmission, which shall contain the link address of the combined station.

8.6.4.2.1.1.3 The control (C) field shall consist of one octet, excluding 0 bits added to achieve transparent transmission, and shall contain the commands, responses, and frame sequence number components for the control of the data link.

8.6.4.2.1.1.4 The information (I) field shall contain digital data which may be presented in any code or sequence but shall not exceed a maximum of 259 octets, excluding 0 bits added to achieve transparent transmission. The I field shall always be a multiple of 8 bits in length.

8.6.4.2.1.1.5 The frame check sequence (FCS) shall consist of two octets, excluding 0 bits added to achieve transparent transmission, and shall contain the error detecting bits.

8.6.4.2.2 A frame check sequence (FCS) shall be included in each frame for the purpose of error checking.

8.6.4.2.2.1 The error checking algorithm shall be a cyclic redundancy check (CRC).

8.6.4.2.2.2 The CRC polynomial ($P(x)$) shall be

$$x^{16} + x^{12} + x^5 + 1.$$

8.6.4.2.2.3 The FCS shall be a 16-bit sequence. This FCS shall be the ones' complement of the remainder, $R(x)$, obtained from the modulo 2 division of

$$x^{16}[G(x)] + x^k(x^{15} + x^{14} + x^{13} + \dots + x^2 + x^1 + 1)$$

by the CRC polynomial, $P(x)$.

$G(x)$ shall be the contents of the frame existing between, but including neither, the final bit of the opening flag nor the first bit of the FCS, excluding bits inserted for transparent transmission.

K shall be the length of $G(x)$ (number of bits).

8.6.4.2.2.4 The generation and checking of the FCS accumulation shall be as follows:

- a) the transmitting station shall initiate the FCS accumulation with the first (least significant) bit of the address (A) field and shall include all bits up to and including the last bit preceding the FCS sequence, but shall exclude all 0 bits (if any) inserted to achieve transparent transmission;
- b) upon completion of the accumulation the FCS shall be transmitted, starting with bit b1 (highest order coefficient) and proceeding in sequence to bit b16 (lowest order coefficient) as shown below;

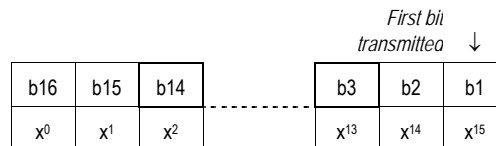

- c) the receiving station shall carry out the cyclic redundancy check (CRC) on the content of the frame commencing with the first bit received following the opening flag, and shall include all bits up to and including the last bit preceding the closing flag, but shall exclude all 0 bits (if any) deleted according to the rules for achievement of transparency;
- d) upon completion of the FCS accumulation, the receiving station shall examine the remainder. In the absence of transmission error, the remainder shall be 1111000010111000 (x^0 through x^{15} , respectively).

8.6.4.2.3 *Achievement of transparency.* The frame format contents (A, C, link data field, and FCS) shall be capable of containing any bit configuration.

8.6.4.2.3.1 The following rules shall apply to all frame contents, except flag sequences:

- a) the transmitting station shall examine the frame contents before transmission, and shall insert a single 0 bit immediately following each sequence of 5 consecutive 1 bits;
- b) the receiving station shall examine the received frame contents for patterns consisting of 5 consecutive 1 bits immediately followed by one (or more) 0 bit(s) and shall remove the 0 bit which directly follows 5 consecutive 1 bits.

8.6.4.2.4 *Special transmission sequences and related link states.* In addition to employing the prescribed repertoire of commands and responses to manage the interchange of data and control information, stations shall use the following conventions to signal the indicated conditions:

- a) *Abort* is the procedure by which a station in the process of sending a frame ends the frame in an unusual manner such that the receiving station shall ignore the frame. The conventions for aborting a frame shall be:
 - 1) transmitting at least seven, but less than fifteen, one bits (with no inserted zeros);
 - 2) receiving seven one bits.

- b) *Active link state.* A link is in an active state when a station is transmitting a frame, an abort sequence, or interframe time fill. When the link is in the active state, the right of the transmitting station to continue transmission shall be reserved.
- c) *Interframe time fill.* Interframe time fill shall be accomplished by transmitting continuous flags between frames. There is no provision for time fill within a frame.
- d) *Idle link state.* A link is in an idle state when a continuous one condition is detected that persists for 15 bit times, or longer. Idle link time fill shall be a continuous one condition on the link.
- e) *Invalid frame.* An invalid frame is one that is not properly bounded by two flags or one which is shorter than 32 bits between flags.

8.6.4.2.5 MODES

8.6.4.2.5.1 *Operational mode.* The operational mode shall be the asynchronous balanced mode (ABM).

8.6.4.2.5.1.1 It shall be permissible for a combined station in ABM to transmit without invitation from the associated station.

8.6.4.2.5.1.2 A combined station in ABM shall be permitted to transmit any command or response type frame except DM.

8.6.4.2.5.2 *Non-operational mode.* The non-operational mode shall be the asynchronous disconnected mode (ADM) in which a combined station is logically disconnected from the data link.

8.6.4.2.5.2.1 It shall be permissible for a combined station in ADM to transmit without invitation from the associated station.

8.6.4.2.5.2.2 A combined station in ADM shall transmit only SABM, DISC, UA and DM frames. (See 8.6.4.2.7 for a description of the commands and responses to which these frame types refer.)

8.6.4.2.5.2.3 A combined station in ADM shall transmit a DM when a DISC is received, and shall discard all other received command frames except SABM. If a discarded command frame has the P bit set to “1”, the combined station shall transmit a DM with the F bit set to “1”.

8.6.4.2.6 *Control field functions and parameters.* Control fields contain a command or a response and sequence numbers where applicable. Three types of control fields shall be used to perform:

- a) numbered information transfer (I-frames);
- b) numbered supervisory functions (S-frames); and
- c) unnumbered control functions (U-frames).

The control field formats shall be as shown in Table 8-5. The functional frame designation associated with each type control field as well as the control field parameters employed in performing these functions shall be described in the following paragraphs.

8.6.4.2.6.1 The I-frame type is used to perform information transfers. Except for some special cases it is the only format which shall be permitted to contain an information field.

8.6.4.2.6.2 The S-frame type is used for supervisory commands and responses that perform link supervisory control functions such as acknowledge information frames, request transmission or retransmission of information frames, and to request a temporary suspension of transmission of I-frames. No information field shall be contained in the S-frame.

8.6.4.2.6.3 The U-frame type is used for unnumbered commands and responses that provide additional link control functions. One of the U-frame responses, the frame reject (FRMR) response, shall contain an information field; all other frames of the U-frame type shall not contain an information field.

8.6.4.2.6.4 The station parameters associated with the three control field types shall be as follows:

- a) *Modulus*. Each I-frame shall be sequentially numbered with a send sequence count, $N(S)$, having value 0 through modulus minus one (where modulus is the modulus of the sequence numbers). The modulus shall be 8. The maximum number of sequentially numbered I-frames that a station shall have outstanding (i.e. unacknowledged) at any given time shall never exceed one less than the modulus of the sequence numbers. This restriction on the number of outstanding frames is to prevent any ambiguity in the association of transmission frames with sequence numbers during normal operation and/or error recovery.
- b) The send state variable $V(S)$ shall denote the sequence number of the next in-sequence I-frame to be transmitted.
 - 1) The send state variable shall take on the value 0 through modulus minus one (modulus is the modulus of the sequence numbering and the numbers cycle through the entire range).
 - 2) The value of $V(S)$ shall be incremented by one with each successive in-sequence I-frame transmission, but shall not exceed the value of $N(R)$ contained in the last received frame by more than the maximum permissible number of outstanding I-frames (k). See i) below for the definition of k .
- c) Prior to transmission of an in-sequence I-frame, the value of $N(S)$ shall be updated to equal the value of $V(S)$.
- d) The receive state variable $V(R)$ shall denote the sequence number of the next in-sequence I-frame to be received.
 - 1) $V(R)$ shall take on the values 0 through modulus minus one.
 - 2) The value of $V(R)$ shall be incremented by one after the receipt of an error-free, in-sequence I-frame whose send sequence number $N(S)$, equals $V(R)$.
- e) All I-frames and S-frames shall contain $N(R)$, the expected sequence number of the next received frame. Prior to transmission of either an I or an S type frame, the value of $N(R)$ shall be updated to equal the current value of the receive state variable. $N(R)$ indicates that the station transmitting the $N(R)$ has correctly received all I-frames numbered up to and including $N(R) - 1$.
- f) Each station shall maintain an independent send state variable, $V(S)$, and receive state variable, $V(R)$, on the I-frames it sends and receives. That is, each combined station shall maintain a $V(S)$ count on the I-frames it transmits and a $V(R)$ count on the I-frames it has correctly received from the remote combined station.
- g) The poll (P/F) bit shall be used by a combined station to solicit (poll) a response or sequence of responses from the remote combined station.
- h) The final (P/F) bit shall be used by the remote combined station to indicate the response frame transmitted as the result of a soliciting (poll) command.
- i) The maximum number (k) of sequentially numbered I-frames that a station may have outstanding (i.e. unacknowledged) at any given time is a station parameter which shall never exceed the modulus.

Note.— k is determined by station buffering limitations and should be the subject of bilateral agreement at the time of circuit establishment.

8.6.4.2.7 *Commands and responses.* It shall be permissible for a combined station to generate either commands or responses. A command shall contain the remote station address while a response shall contain the sending station address. The mnemonics associated with all of the commands and responses prescribed for each of the three frame types (I, S, and U) and the corresponding encoding of the control field are as shown in Table 8-6.

8.6.4.2.7.1 The I-frame command provides the means for transmitting sequentially numbered frames, each of which shall be permitted to contain an information field.

8.6.4.2.7.2 The S-frame commands and responses shall be used to perform numbered supervisory functions (such as acknowledgement, polling, temporary suspension of information transfer, or error recovery).

8.6.4.2.7.2.1 The receive ready command or response (RR) shall be used by a station to:

- a) indicate that it is ready to receive an I-frame;
- b) acknowledge previously received I-frames numbered up to and including $N(R) - 1$;
- c) clear a busy condition that was initiated by the transmission of RNR.

Note.— It is permissible for a combined station to use the RR command to solicit a response from the remote combined station with the poll bit set to “1”.

8.6.4.2.7.2.2 It shall be permissible to issue a reject command or response (REJ) to request retransmission of frames starting with the I-frame numbered $N(R)$ where:

- a) I-frames numbered $N(R) - 1$ and below are acknowledged;
- b) additional I-frames pending initial transmission are to be transmitted following the retransmitted I-frame(s);
- c) only one REJ exception condition, from one given station to another station, shall be established at any given time: another REJ shall not be issued until the first REJ exception condition has been cleared;
- d) the REJ exception condition is cleared (reset) upon the receipt of an I-frame with an $N(S)$ count equal to the $N(R)$ of the REJ command/response.

8.6.4.2.7.2.3 The receive not ready command or response (RNR) shall be used to indicate a busy condition, i.e. temporary inability to accept additional incoming I-frames, where:

- a) frames numbered up to and including $N(R) - 1$ are acknowledged;
- b) frame $N(R)$ and any subsequent I-frames received, if any, are not acknowledged (the acceptance status of these frames shall be indicated in subsequent exchanges);
- c) the clearing of a busy condition shall be indicated by the transmission of an RR, REJ, SABM, or UA with or without the P/F bit set to “1”.

8.6.4.2.7.2.3.1 **Recommendation.**—

- a) A station receiving an RNR frame when in the process of transmitting should stop transmitting I-frames at the earliest possible time.

- b) Any REJ command or response which was received prior to the RNR should be actioned before the termination of transmission.
- c) It should be permissible for a combined station to use the RNR command with the poll bit set to "1" to obtain a supervisory frame with the final bit set to "1" from the remote combined station.

8.6.4.2.7.2.4 It shall be permissible for the selective reject command or response (SREJ) to be used to request retransmission of the single I-frame numbered $N(R)$ where:

- a) frames numbered up to $N(R) - 1$ are acknowledged; frame $N(R)$ is not accepted; the only I-frames accepted are those received correctly and in sequence following the I-frame requested; the specific I-frame to be retransmitted is indicated by the $N(R)$ in the SREJ command/response;
- b) the SREJ exception condition is cleared (reset) upon receipt of an I-frame with an $N(S)$ count equal to the $N(R)$ of the SREJ;
- c) after a station transmits a SREJ it is not permitted to transmit SREJ or REJ for an additional sequence error until the first SREJ error condition has been cleared;
- d) I-frames that have been permitted to be transmitted following the I-frame indicated by the SREJ are not retransmitted as the result of receiving a SREJ; and
- e) it is permissible for additional I-frames pending initial transmission to be transmitted following the retransmission of the specific I-frame requested by the SREJ.

8.6.4.2.7.3 The U-frame commands and responses shall be used to extend the number of link control functions. Transmitted U-frames do not increment the sequence counts at either the transmitting or receiving station.

- a) The U-frame mode-setting commands (SABM, and DISC) shall be used to place the addressed station in the appropriate response mode (ABM or ADM) where:
 - 1) upon acceptance of the command, the station send and receive state variables, $V(S)$ and $V(R)$, are set to zero;
 - 2) the addressed station confirms acceptance at the earliest possible time by transmission of a single unnumbered acknowledgement, UA;
 - 3) previously transmitted frames that are unacknowledged when the command is actioned remain unacknowledged;
 - 4) the DISC command is used to perform a logical disconnect, i.e. to inform the addressed combined station that the transmitting combined station is suspending operation. No information field shall be permitted with the DISC command.
- b) The unnumbered acknowledge response (UA) shall be used by a combined station to acknowledge the receipt and acceptance of an unnumbered command. Received unnumbered commands are not actioned until the UA response is transmitted. No information field shall be permitted with the UA response.
- c) The frame reject response (FRMR), employing the information field described below, shall be used by a combined station in the operational mode (ABM) to report that one of the following conditions resulted from the receipt of a frame without an FCS error:
 - 1) a command/response that is invalid or not implemented;
 - 2) a frame with an information field that exceeds the size of the buffer available;

- 3) a frame having an invalid $N(R)$ count.

Note.— An invalid $N(R)$ is a count which points to an I-frame which has previously been transmitted and acknowledged or to an I-frame which has not been transmitted and is not the next sequential I-frame pending transmission.

- d) The disconnected mode response (DM) shall be used to report a non-operational status where the station is logically disconnected from the link. No information field shall be permitted with the DM response.

Note.— The DM response shall be sent to request the remote combined station to issue a mode-setting command or, if sent in response to the reception of a mode-setting command, to inform the remote combined station that the transmitting station is still in ADM and cannot action the mode-setting command.

8.6.4.3 EXCEPTION CONDITION REPORTING AND RECOVERY

This section specifies the procedures that shall be employed to effect recovery following the detection or occurrence of an exception condition at the link level. Exception conditions described are those situations that may occur as the result of transmission errors, station malfunction, or operational situations.

8.6.4.3.1 *Busy condition.* A busy condition occurs when a station temporarily cannot receive or continue to receive I-frames due to internal constraints, e.g. due to buffering limitations. The busy condition shall be reported to the remote combined station by the transmission of an RNR frame with the $N(R)$ number of the next I-frame that is expected. It shall be permissible for traffic pending transmission at the busy station to be transmitted prior to or following the RNR.

Note.— The continued existence of a busy condition must be reported by retransmission of RNR at each P/F frame exchange.

8.6.4.3.1.1 Upon receipt of an RNR, a combined station in ABM shall cease transmitting I-frames at the earliest possible time by completing or aborting the frame in process. The combined station receiving an RNR shall perform a time-out operation before resuming asynchronous transmission of I-frames unless the busy condition is reported as cleared by the remote combined station. If the RNR was received as a command with the P bit set to “1”, the receiving station shall respond with an S-frame with the F bit set to “1”.

8.6.4.3.1.2 The busy condition shall be cleared at the station which transmitted the RNR when the internal constraint ceases. Clearance of the busy condition shall be reported to the remote station by transmission of an RR, REJ, SABM, or UA frame (with or without the P/F bit set to “1”).

8.6.4.3.2 *$N(S)$ sequence error.* An $N(S)$ sequence exception shall be established in the receiving station when an I-frame that is received error free (no FCS error) contains an $N(S)$ sequence number that is not equal to the receive variable $V(R)$ at the receiving station. The receiving station shall not acknowledge (shall not increment its receive variable $V(R)$) the frame causing the sequence error, or any I-frames which may follow, until an I-frame with the correct $N(S)$ number is received. A station that receives one or more I-frames having sequence errors, but which are otherwise error free, shall accept the control information contained in the $N(R)$ field and the P/F bit to perform link control functions, e.g. to receive acknowledgement of previously transmitted I-frames (via the $N(R)$), to cause the station to respond (P bit set to “1”).

8.6.4.3.2.1 The means specified in 8.6.4.3.2.1.1 and 8.6.4.3.2.1.2 shall be available for initiating the retransmission of lost or errored I-frames following the occurrence of a sequence error.

8.6.4.3.2.1.1 Where the REJ command/response is used to initiate an exception recovery following the detection of a sequence error, only one “sent REJ” exception condition, from one station to another station, shall be established at a time. A “sent REJ” exception shall be cleared when the requested I-frame is received. A station receiving REJ shall initiate sequential (re)transmission of I-frames starting with the I-frame indicated by the $N(R)$ contained in the REJ frame.

FRMR INFORMATION FIELD BITS FOR BASIC (SABM) OPERATION

<i>First bit transmitted</i>													
1	8	9	10	12	13	14	16	17	18	19	20	21	24
rejected basic control field		0	$V(S)$		v	$V(R)$		w	x	y	z	set to zero	

where:

rejected basic control field is the control field of the received frame which caused the frame reject;

$V(S)$ is the current value of the send state variable at the remote combined station reporting the error condition (bit 10 = low order bit);

$V(R)$ is the current value of the receive state variable at the remote combined station reporting the error condition (bit 14 = low order bit);

v set to “1” indicates that the received frame which caused rejection was a response;

w set to “1” indicates that the control field received and returned in bits 1 through 8 are invalid or not implemented;

x set to “1” indicates that the control field received and returned in bits 1 through 8 was considered invalid because the frame contained an information field which is not permitted with this command. Bit w must be set to “1” in conjunction with this bit;

y set to “1” indicates that the information field received exceeded the maximum information field length which can be accommodated by the station reporting the error condition. This bit is mutually exclusive with bits w and x above;

z set to “1” indicates that the control field received and returned in bits 1 through 8 contained an invalid $N(R)$ count. This bit is mutually exclusive with bit w .

8.6.4.3.2.1.2 In the event a receiving station, due to a transmission error, does not receive (or receives and discards) a single I-frame or the last I-frame(s) in a sequence of I-frames, it shall not detect an out-of-sequence exception and, therefore, shall not transmit REJ. The station which transmitted the unacknowledged I-frame(s) shall, following the completion of a system-specified time-out period, take appropriate recovery action to determine the sequence number at which retransmission must begin.

8.6.4.3.2.1.3 **Recommendation.**— *A combined station which has timed out waiting for a response should not retransmit all unacknowledged frames immediately. The station may enquire about status with a supervisory frame.*

Note 1.— *If a station does retransmit all unacknowledged I-frames after a time-out, it must be prepared to receive a subsequent REJ frame with an $N(R)$ greater than its send variable $V(S)$.*

Note 2.— *Since contention may occur in the case of two-way alternate communications in ABM or ADM, the time-out interval employed by one combined station must be greater than that employed by the other combined station so as to permit contention to be resolved.*

8.6.4.3.3 **FCS error.** Any frame with an FCS error shall not be accepted by the receiving station and will be discarded. No action shall be taken by the receiving station as the result of that frame.

8.6.4.3.4 **Frame reject exception condition.** A frame reject exception condition shall be established upon the receipt of an error-free frame which contains an invalid or unimplemented control field, an invalid $N(R)$, or an information field which

has exceeded the maximum established storage capability. If a frame reject exception condition occurs in a combined station, the station shall either:

- a) take recovery action without reporting the condition to the remote combined station; or
- b) report the condition to the remote combined station with a FRMR response. The remote station will then be expected to take recovery action; if, after waiting an appropriate time, no recovery action appears to have been taken, the combined station reporting the frame reject exception condition may take recovery action.

Recovery action for balanced operation includes the transmission of an implemented mode-setting command. Higher level functions may also be involved in the recovery.

8.6.4.3.5 *Mode-setting contention.* A mode-setting contention situation exists when a combined station issues a mode-setting command and, before receiving an appropriate response (UA or DM), receives a mode-setting command from the remote combined station. Contention situations shall be resolved in the following manner:

- a) when the send and receive mode-setting commands are the same, each combined station shall send a UA response at the earliest respond opportunity. Each combined station shall either enter the indicated mode immediately or defer entering the indicated mode until receiving a UA response. In the latter case, if the UA response is not received:
 - 1) the mode may be entered when the response timer expires; or
 - 2) the mode-setting command may be reissued;
- b) when the mode-setting commands are different, each combined station shall enter ADM and issue a DM response at the earliest respond opportunity. In the case of DISC contention with a different mode-setting command, no further action is required.

8.6.4.3.6 *Time-out functions.* Time-out functions shall be used to detect that a required or expected acknowledging action or response to a previously transmitted frame has not been received. Expiration of the time-out function shall initiate appropriate action, e.g. error recovery or reissuance of the P bit. The duration of the following time-out functions is system dependent and subject to bilateral agreement:

- a) combined stations shall provide a time-out function to determine that a response frame with F bit set to “1” to a command frame with the P bit set to “1” has not been received. The time-out function shall automatically cease upon receipt of a valid frame with the F bit set to “1”;
- b) a combined station which has no P bit outstanding, and which has transmitted one or more frames for which responses are anticipated shall start a time-out function to detect the no-response condition. The time-out function shall cease when an I- or S-frame is received with the $N(R)$ higher than the last received $N(R)$ (actually acknowledging one or more I-frames).

8.6.5 Common ICAO data interchange network (CIDIN)

8.6.5.1 INTRODUCTION

Note 1.— The common ICAO data interchange network (CIDIN) is an element of the aeronautical fixed service (AFS) which uses bit-oriented procedures, store and forward techniques and packet switching techniques based on CCITT Recommendation X.25 to carry messages of specific applications of the AFS such as AFTN and operational meteorological information (OPMET).

Note 2.— The CIDIN provides a reliable common network service for the conveyance of application messages in binary or text form to air traffic service providers and aircraft operating agencies.

8.6.5.1.1 CIDIN entry and exit centres or stations shall be used to connect application entities to the CIDIN.

Note.— The interfacing between CIDIN and application entities is a matter for local implementation.

8.6.5.1.2 CIDIN relay centres shall be used to forward packets between CIDIN entry and exit centres or stations which are not directly connected.

8.6.5.2 GENERAL

8.6.5.2.1 There shall be four protocol levels defined to control the transfer of messages between CIDIN switching centres:

- the data link protocol level
- the X.25 packet protocol level
- the CIDIN packet protocol level
- the CIDIN transport protocol level.

Note 1.— The relationship of the terms used is shown in Figures 8-1 and 8-2.

Note 2.— The details of CIDIN communication procedures and system specifications, as implemented in Europe, are shown in the EUR CIDIN Manual (EUR Doc 005).

8.6.5.2.2 THE DATA LINK PROTOCOL LEVEL

8.6.5.2.2.1 X.25 packets to be transferred between two CIDIN switching centres or a CIDIN switching centre and a packet switched data network, shall be formatted into data link frames.

8.6.5.2.2.2 Each data link frame shall consist of a data link control field (DLCF), possibly followed by a link data field, and shall be terminated by a frame check sequence and flag (being the second part of the DLCF). If a link data field is present, the frame shall be denoted as an information frame.

8.6.5.2.2.3 X.25 packets shall be transmitted within the link data field of information frames. Only one packet shall be contained in the link data field.

8.6.5.2.3 THE X.25 PACKET PROTOCOL LEVEL

8.6.5.2.3.1 Each CIDIN packet to be transferred on CIDIN circuits between CIDIN switching centres shall be formatted into one X.25 packet. When a packet switched data network is used, it shall be permissible to format the CIDIN packet into more than one X.25 packet.

8.6.5.2.3.2 The integrity of each CIDIN packet shall be preserved by the X.25 packet protocol by mapping each CIDIN packet onto one complete X.25 packet sequence, as defined in CCITT Recommendation X.25.

8.6.5.2.3.3 Each X.25 packet shall consist of an X.25 packet header, possibly followed by a user data field (UDF).

8.6.5.2.3.4 The X.25 packet protocol is based on the application of virtual circuit procedures. A virtual circuit shall be defined as a logical path between two CIDIN switching centres. If a packet switched data network is used to interconnect two CIDIN switching centres, the procedure shall provide full compatibility with the procedures to be followed for virtual circuits according to CCITT Recommendation X.25.

8.6.5.2.4 THE CIDIN PACKET PROTOCOL LEVEL

8.6.5.2.4.1 Each transport header and the associated segment shall be preceded by a CIDIN packet header. No further segmentation of the CIDIN message shall be used between transport protocol level and CIDIN packet protocol level. Both headers, therefore, shall be used in combination. Together they shall be referred to as the communications control field (CCF). Together with the message segment they form CIDIN packets that shall be transmitted from entry centre to exit centre(s), when necessary through one or more relay centres, as an entity.

8.6.5.2.4.2 CIDIN packets of one CIDIN message shall be relayed independently via predetermined routes through the network thus allowing alternative routing on a CIDIN packet basis as necessary.

8.6.5.2.4.3 The CIDIN packet header shall contain information to enable relay centres to handle CIDIN packets in the order of priority, to transmit the CIDIN packets on the proper outgoing circuit(s) and to duplicate or multiply CIDIN packets when required for multiple dissemination purposes. The information shall be sufficient to apply address stripping on the exit addresses as well as on the addressee indicators of messages in AFTN format.

8.6.5.2.5 THE TRANSPORT PROTOCOL LEVEL

8.6.5.2.5.1 Information exchanged over the CIDIN shall be transmitted as CIDIN messages.

8.6.5.2.5.2 The length of a CIDIN message shall be defined by the CIDIN packet sequence number (CPSN). The maximum permissible length is 2^{15} packets which in effect results in no practical limitation.

8.6.5.2.5.3 If the length of a CIDIN message and its transport and packet headers (as defined below) exceeds 256 octets, the message shall be divided into segments and placed in the CIDIN user data field of CIDIN packets. Each segment shall be preceded by a transport header containing information to enable the re-assembly of the CIDIN message at the exit centre(s) from individually received segments and to determine further handling of the received complete CIDIN message.

8.6.5.2.5.4 All segments of one CIDIN message shall be provided with the same message identification information in the transport header. Only the CPSN and final CIDIN packet (FCP) indicator shall be different.

8.6.5.2.5.5 Recovery of messages shall be performed at the transport level.

TABLES FOR CHAPTER 8

Table 8-1. International Telegraph Alphabets No. 2 and No. 3

Number of signal	Letter case	Figure case	Impulses 5-unit code		
			Start	12345	Stop
<i>International Code No. 2</i>					
1	A	—	A	ZZAAA	Z
2	B	?	A	ZAAZZ	Z
3	C	:	A	AZZZA	Z
4	D	Note 1	A	ZAAZA	Z
5	E	3	A	ZAAAA	Z
6	F		A	ZAZZA	Z
7	G		A	AZAZZ	Z
8	H		A	AAZAZ	Z
9	I	8	A	AZZAA	Z
10	J	Attention signal	A	ZZAZA	Z
11	K	(A	ZZZZA	Z
12	L)	A	AZAAZ	Z
13	M	.	A	AAZZZ	Z
14	N	,	A	AAZZA	Z
15	O	9	A	AAAZZ	Z
16	P	0	A	AZZAZ	Z
17	Q	1	A	ZZZAZ	Z
18	R	4	A	AZAZA	Z
19	S	'	A	ZAZAA	Z
20	T	5	A	AAAAZ	Z
21	U	7	A	ZZZAA	Z
22	V	=	A	AZZZZ	Z
23	W	2	A	ZZAAZ	Z
24	X	/	A	ZAZZZ	Z
25	Y	6	A	ZAZAZ	Z
26	Z	+	A	ZAAAZ	Z
27	carriage return		A	AAAZA	Z
28	line feed		A	AZAAA	Z
29	letters		A	ZZZZZ	Z
30	figures		A	ZZAZZ	Z
31	space		A	AAZAA	Z
32	unperforated tape		A	AAAAA	Z
33	signal repetition				
34	signal α				
35	signal β				

Sign	Closed circuit	Double current
A	No current	Negative current
Z	Positive current	Positive current

Note 1.— Used for answer-back facility.

Table 8-2. International Alphabet No. 5 (IA-5)
(international reference version)

				b ₇	0	0	0	0	1	1	1	1
				b ₆	0	0	1	1	0	0	1	1
				b ₅	0	1	0	1	0	1	0	1
b ₄	b ₃	b ₂	b ₁		0	1	2	3	4	5	6	7
0	0	0	0	0	NUL	TC ₇ (DLE)	SP	0	@	P	`	p
0	0	0	1	1	TC ₁ (SOH)	DC ₁	!	1	A	Q	a	q
0	0	1	0	2	TC ₂ (STX)	DC ₂	" ④	2	B	R	b	r
0	0	1	1	3	TC ₃ (ETX)	DC ₃	#	3	C	S	c	s
0	1	0	0	4	TC ₄ (EOT)	DC ₄	¤ ②	4	D	T	d	t
0	1	0	1	5	TC ₅ (ENQ)	TC ₈ (NAK)	%	5	E	U	e	u
0	1	1	0	6	TC ₆ (ACK)	TC ₉ (SYN)	&	6	F	V	f	v
0	1	1	1	7	BEL	TC ₁₀ (ETB)	' ④	7	G	W	g	w
1	0	0	0	8	FE ₀ (BS)	CAN	(8	H	X	h	x
1	0	0	1	9	FE ₁ (HT)	EM)	9	I	Y	i	y
1	0	1	0	10	FE ₂ ① (LF)	SUB	*	:	J	Z	j	z
1	0	1	1	11	FE ₃ (VT)	ESC	+	;	K	[k	{
1	1	0	0	12	FE ₄ (FF)	IS ₄ (FS)	④ ,	<	L	\	l	
1	1	0	1	13	FE ₅ ① (CR)	IS ₃ (GS)	-	=	M]	m	}
1	1	1	0	14	SO	IS ₂ (RS)	.	>	N	^ ④	n	- ③
1	1	1	1	15	SI	IS ₁ (US)	/	?	O	—	o	DEL

NOTES

Note 1.—The format effectors are intended for equipment in which horizontal and vertical movements are effected separately. If equipment requires the action of CARRIAGE RETURN to be combined with a vertical movement, the format effector for that vertical movement may be used to effect the combined movement. Use of FE 2 for a combined CR and LF operation is not allowed for international transmission on AFS networks.

Note 2.—The symbol ¤ does not designate the currency of a specific country.

Note 3.—Position 7/14 is used for graphic character $\bar{\text{~}}$ (OVERLINE), the graphical representation of which may vary according to national use to represent (TILDE) or another diacritical sign provided that there is no risk of confusion with another graphic character included in the table.

Note 4.—The graphic characters in position 2/2, 2/7, 2/12 and 5/14 have respectively the significance of QUOTATION MARK, APOSTROPHE, COMMA and UPWARD ARROW HEAD; however, these characters take on the significance of the diacritical signs DIAERESIS, ACUTE ACCENT, CEDILLA and CIRCUMFLEX ACCENT when they are preceded or followed by the BACKSPACE character (0/8).

Note 5.—When graphical representation of the control characters of IA-5 is required, it is permissible to use the symbols specified in International Organization for Standardization (ISO) Standard 2047-1975.

CONTROL CHARACTERS

Abbreviation	Meaning	Position in the code table
ACK	Acknowledge	0/6
BEL	Bell	0/7
BS	Backspace	0/8
CAN	Cancel	1/8
CR	Carriage return*	0/13
DC	Device control	—
DEL	Delete	7/15
DLE	Data link escape	1/0
EM	End of medium	1/9
ENQ	Enquiry	0/5
EOT	End of transmission	0/4
ESC	Escape	1/11
ETB	End of transmission block	1/7
ETX	End of text	0/3
FE	Format effector	—
FF	Form feed	0/12
FS	File separator	1/12
GS	Group separator	1/13
HT	Horizontal tabulation	0/9
IS	Information separator	—
LF	Line feed*	0/10
NAK	Negative acknowledge	1/5
NUL	Null	0/0
RS	Record separator	1/14
SI	Shift-in	0/15
SO	Shift-out	0/14
SOH	Start of heading	0/1
SP	Space	2/0
STX	Start of text	0/2
SUB	Substitute character	1/10
SYN	Synchronous idle	1/6
TC	Transmission control	—
US	Unit separator	1/15
VT	Vertical tabulation	0/11

GRAPHIC CHARACTERS

Graphic	Note	Name	Position in the code table
(space)		Space (see 7.2)	2/0
!		Exclamation mark	2/1
"	4	Quotation mark, Diaeresis	2/2
#		Number sign	2/3
¤	2	Currency sign	2/4
%		Percent sign	2/5
&		Ampersand	2/6
'	4	Apostrophe, Acute accent	2/7
(Left parenthesis	2/8
)		Right parenthesis	2/9
*		Asterisk	2/10
+		Plus sign	2/11
,	4	Comma, Cedilla	2/12
—		Hyphen, Minus sign	2/13
.		Full stop (period)	2/14
/		Solidus	2/15
:		Colon	3/10
;		Semi-colon	3/11
<		Less-than sign	3/12
=		Equal sign	3/13
>		Greater-than sign	3/14
?		Question mark	3/15
@		Commercial 'at'	4/0
[Left square bracket	5/11
\		Reverse solidus	5/12
]		Right square bracket	5/13
^	4	Upward arrow head, Circumflex accent	5/14
—		Underline	5/15
`		Grave accent	6/0
{		Left curly bracket	7/11
		Vertical line	7/12
}		Right curly bracket	7/13
—	3	Overline, Tilde	7/14

* See Note 1.

DIACRITICAL SIGNS

In the character set, some printing symbols may be designed to permit their use for the composition of accented letters when necessary for general interchange of information. A sequence of three characters, comprising a letter, BACKSPACE and one of these symbols, is needed for this composition, and the symbol is then regarded as a diacritical sign. It should be noted that these symbols take on their diacritical significance only when they are preceded or followed by the BACKSPACE character: for example, the symbol corresponding to the code combination 2/7 (') normally has the significance of APOSTROPHE, but becomes the diacritical sign ACUTE ACCENT when it precedes or follows the BACKSPACE character.

NAMES, MEANINGS AND FONTS OF GRAPHIC CHARACTERS

At least one name is assigned to denote each of the graphic characters. These names are intended to reflect their customary meanings and are not intended to define or restrict the meanings of graphic characters. No particular style or font design is specified for the graphic characters.

UNIQUENESS OF CHARACTER ALLOCATION

A character allocated to a position in the table may not be placed elsewhere in the table.

FUNCTIONAL CHARACTERISTICS RELATED TO CONTROL CHARACTERS

Some definitions given below are stated in general terms and more explicit definitions of use may be needed for specific implementation of the code table on recording media or on transmission channels. These more explicit definitions and the use of these characters are the subject of ISO publications.

General designations of control characters

The general designation of control characters involves a specific class name followed by a subscript number.

They are defined as follows:

- TC — *Transmission control characters* — Control characters intended to control or facilitate transmission of information over telecommunication networks.
The use of the TC characters on the general telecommunication networks is the subject of ISO publications.
The transmission control characters are:
ACK, DLE, ENQ, EOT, ETB, ETX, NAK, SOH, STX and SYN.
- FE — *Format effectors* — Control characters mainly intended for the control of the layout and positioning of information on printing and/or display devices. In the definitions of specific format effectors, any reference to printing devices should be interpreted as including display devices. The definitions of format effectors use the following concept:
- a) a page is composed of a number of lines of characters;
 - b) the characters forming a line occupy a number of positions called character positions;
 - c) the active position is that character position in which the character about to be processed would appear if it were to be printed. The active position normally advances one character position at a time.
- The format effector characters are:
BS, CR, FF, HT, LF and VT.
- DC — *Device control characters* — Control characters for the control of a local or remote ancillary device (or devices) connected to a data processing and/or telecommunication system. These control characters are not intended to control telecommunication systems; this should be achieved by the use of TCs.
Certain preferred uses of the individual DCs are given below under *Specific control characters*.
- IS — *Information separators* — Control characters that are used to separate and qualify data logically. There are four such characters. They may be used either in hierarchical order or non-hierarchically; in the latter case their specific meanings depend on their applications.
When they are used hierarchically, the ascending order is:
US, RS, GS, FS.
In this case data normally delimited by a particular separator cannot be split by a higher order separator but will be considered as delimited by any higher order separator.

Specific control characters

Individual members of the classes of controls are sometimes referred to by their abbreviated class name and a subscript number (e.g. TC₅) and sometimes by a specific name indicative of their use (e.g. ENQ).

Different but related meanings may be associated with some of the control characters but in an interchange of data this normally requires agreement between the sender and the recipient.

- ACK — *Acknowledge* — A transmission control character transmitted by a receiver as an affirmative response to the sender.
- BEL — *Bell* — A control character that is used when there is a need to call for attention; it may control alarm or attention devices.
- BS — *Backspace* — A format effector which moves the active position one character position backwards on the same line.
- CAN — *Cancel* — A character, or the first character of a sequence, indicating that the data preceding it are in error. As a result these data are to be ignored. The specific meaning of this character must be defined for each application and/or between sender and recipient.
- CR — *Carriage return* — A format effector which moves the active position to the first character position on the same line.

Device controls

- DC₁ — A device control character which is primarily intended for turning on or starting an ancillary device. If it is not required for this purpose, it may be used to restore a device to the basic mode of operation (*see also* DC₂ and DC₃), or for any other device control function not provided by other DCs.
- DC₂ — A device control character which is primarily intended for turning on or starting an ancillary device. If it is not required for this purpose, it may be used to set a device to a special mode of operation (in which case DC₁ is used to restore the device to the basic mode), or for any other device control function not provided by other DCs.
- DC₃ — A device control character which is primarily intended for turning off or stopping an ancillary device. This function may be a secondary level stop, e.g. wait, pause, stand-by or halt (in which case DC₁ is used to restore normal operation). If it is not required for this purpose, it may be used for any other device control function not provided by other DCs.

DC ₄	<p>— A device control character which is primarily intended for turning off, stopping or interrupting an ancillary device. If it is not required for this purpose, it may be used for any other device control function not provided by other DCs.</p> <p><i>Examples of use of the device controls</i></p> <p>1) One switching on — DC₂ off — DC₄</p> <p>2) Two independent switchings First one on — DC₂ off — DC₄ Second one on — DC₁ off — DC₃</p> <p>3) Two dependent switchings General on — DC₂ off — DC₄ Particular on — DC₁ off — DC₃</p> <p>4) Input and output switching Output on — DC₂ off — DC₄ Input on — DC₁ off — DC₃</p>
DEL	— <i>Delete</i> — A character used primarily to erase or obliterate an erroneous or unwanted character in punched tape. DEL characters may also serve to accomplish media-fill or time-fill. They may be inserted into or removed from a stream of data without affecting the information content of that stream, but then the addition or removal of these characters may affect the information layout and/or the control of equipment.
DLE	— <i>Data link escape</i> — A transmission control character which will change the meaning of a limited number of contiguously following characters. It is used exclusively to provide supplementary data transmission control functions. Only graphic characters and transmission control characters can be used in DLE sequences.
EM	— <i>End of medium</i> — A control character that may be used to identify the physical end of a medium, or the end of the used portion of a medium, or the end of the wanted portion of data recorded on a medium. The position of this character does not necessarily correspond to the physical end of the medium.
ENQ	— <i>Enquiry</i> — A transmission control character used as a request for a response from a remote station — the response may include station identification and/or station status. When a "Who are you?" function is required on the general switched transmission network, the first use of ENQ after the connection is established shall have the meaning "Who are you?" (station identification). Subsequent use of ENQ may, or may not, include the function "Who are you?", as determined by agreement.
EOT	— <i>End of transmission</i> — A transmission control character used to indicate the conclusion of the transmission of one or more texts.
ESC	<p>— <i>Escape</i> — A control character which is used to provide an additional control function. It alters the meaning of a limited number of contiguously following bit combinations which constitute the escape sequence.</p> <p>Escape sequences are used to obtain additional control functions which may provide among other things graphic sets outside the standard set. Such control functions must not be used as additional transmission controls.</p> <p>The use of the character ESC and of the escape sequences in conjunction with code extension techniques is the subject of an ISO Standard.</p>
ETB	— <i>End of transmission block</i> — A transmission control character used to indicate the end of a transmission block of data where data are divided into such blocks for transmission purposes.
ETX	— <i>End of text</i> — A transmission control character which terminates a text.
FF	— <i>Form feed</i> — A format effector which advances the active position to the same character position on a predetermined line of the next form or page.
HT	— <i>Horizontal tabulation</i> — A format effector which advances the active position to the next predetermined character position on the same line.
<i>Information separators</i>	
IS ₁ (US)	— A control character used to separate and qualify data logically; its specific meaning has to be defined for each application. If this character is used in hierarchical order as specified in the general definition of IS, it delimits a data item called a UNIT.
IS ₂ (RS)	— A control character used to separate and qualify data logically; its specific meaning has to be defined for each application. If this character is used in hierarchical order as specified in the general definition of IS, it delimits a data item called a RECORD.
IS ₃ (GS)	— A control character used to separate and qualify data logically; its specific meaning has to be defined for each application. If this character is used in hierarchical order as specified in the general definition of IS, it delimits a data item called a GROUP.
IS ₄ (FS)	— A control character used to separate and qualify data logically; its specific meaning has to be defined for each application. If this character is used in hierarchical order as specified in the general definition of IS, it delimits a data item called a FILE.
LF	— <i>Line feed</i> — A format effector which advances the active position to the same character position of the next line.
NAK	— <i>Negative acknowledge</i> — A transmission control character transmitted by a receiver as a negative response to the sender.
NUL	— <i>Null</i> — A control character used to accomplish media-fill or time-fill. NUL characters may be inserted into or removed from a stream of data without affecting the information content of that stream, but then the addition or removal of these characters may affect the information layout and/or the control of equipment.

SI	— <i>Shift-in</i> — A control character which is used in conjunction with SHIFT-OUT and ESCAPE to extend the graphic character set of the code. It may reinstate the standard meanings of the bit combinations which follow it. The effect of this character when using code extension techniques is described in an ISO Standard.
SO	— <i>Shift-out</i> — A control character which is used in conjunction with SHIFT-IN and ESCAPE to extend the graphic character set of the code. It may alter the meaning of the bit combinations of columns 2 to 7 which follow it until a SHIFT-IN character is reached. However, the characters SPACE (2/0) and DELETE (7/15) are unaffected by SHIFT-OUT. The effect of this character when using code extension techniques is described in an ISO Standard.
SOH	— <i>Start of heading</i> — A transmission control character used as the first character of a heading of an information message.
SP	— <i>Space</i> — A character which advances the active position one character position on the same line. This character is also regarded as a non-printing graphic.
STX	— <i>Start of text</i> — A transmission control character which precedes a text and which is used to terminate a heading.
SUB	— <i>Substitute character</i> — A control character used in the place of a character that has been found to be invalid or in error. SUB is intended to be introduced by automatic means.
SYN	— <i>Synchronous idle</i> — A transmission control character used by a synchronous transmission system in the absence of any other character (idle condition) to provide a signal from which synchronism may be achieved or retained between data terminal equipment.
VT	— <i>Vertical tabulation</i> — A format effector which advances the active position to the same character position on the next predetermined line.

Table 8-3. Conversion from the International Telegraph Alphabet No. 2 (ITA-2) to the International Alphabet No. 5 (IA-5)

<i>ITA-2 letter case of signal No.</i>		<i>IA-5 column/row</i>		<i>ITA-2 figure case of signal No.</i>		<i>IA-5 column/row</i>	
1	A	4/1	A	1	—	2/13	—
2	B	4/2	B	2	?	3/15	?
3	C	4/3	C	3	:	3/10	:
4	D	4/4	D	4		3/15	?
5	E	4/5	E	5	3	3/3	3
6	F	4/6	F	6		3/15	?
7	G	4/7	G	7		3/15	?
8	H	4/8	H	8		3/15	?
9	I	4/9	I	9	8	3/8	8
10	J	4/10	J	10	Attention Signal (Note 3)	0/7	Bel
11	K	4/11	K	11	(2/8	(
12	L	4/12	L	12)	2/9)
13	M	4/13	M	13	.	2/14	.
14	N	4/14	N	14	,	2/12	,
15	O	4/15	O	15	9	3/9	9
16	P	5/0	P	16	0	3/0	0
17	Q	5/1	Q	17	1	3/1	1
18	R	5/2	R	18	4	3/4	4
19	S	5/3	S	19	'	2/7	'
20	T	5/4	T	20	5	3/5	5
21	U	5/5	U	21	7	3/7	7
22	V	5/6	V	22	=	3/13	=
23	W	5/7	W	23	2	3/2	2
24	X	5/8	X	24	/	2/15	/
25	Y	5/9	Y	25	6	3/6	6
26	Z	5/10	Z	26	+	2/11	+
27	CR	0/13	CR	27	CR	0/13	CR
28	LF	0/10	LF	28	LF	0/10	LF
29	LTRS	*		29	LTRS	*	
30	FIGS	*		30	FIGS	*	
31	SP	2/0	SP	31	SP	2/0	SP
32		*		32		*	

* No conversion shall be made for these positions and the signal/character shall be removed from the data.

Note 1.— The end-of-message signal NNNN (in letter and figure case) shall convert to ETX (0/3).

Note 2.— The start-of-message signal ZCZC (in letter and figure case) shall convert to SOH (0/1).

Note 3.— Figures case of Signal No. 10 shall only be converted upon detection of the AFTN priority alarm which shall convert to five occurrences of BEL (0/7).

Note 4.— When converting from ITA-2, a STX (0/2) character shall be inserted once at the beginning of the next line following detection of CR LF or LF CR at the end of the Origin Line.

Note 5.— The sequence of seven signal 28 (LF) shall convert to one VT (0/11) character.

**Table 8-4. Conversion from the International Alphabet No. 5 (IA-5)
to the International Telegraph Alphabet No. 2 (ITA-2)**

Row \ Col.	0	1	2	3	4	5	6	7
0	*	*	31FL	16F	2F	16L	2F	16L
1	Note 5	*	2F	17F	1L	17L	1L	17L
2	*	*	2F	23F	2L	18L	2L	18L
3	Note 1	*	2F	5F	3L	19L	3L	19L
4	*	*	2F	18F	4L	20L	4L	20L
5	*	*	2F	20F	5L	21L	5L	21L
6	*	*	2F	25F	6L	22L	6L	22L
7	Note 2	*	19F	21F	7L	23L	7L	23L
8	*	*	11F	9F	8L	24L	8L	24L
9	*	*	12F	15F	9L	25L	9L	25L
10	28 FL	*	2F	3F	10L	26L	10L	26L
11	Note 3	*	26F	2F	11L	2F	11L	2F
12	*	*	14F	2F	12L	2F	12L	2F
13	27FL	*	1F	22F	13L	2F	13L	2F
14	*	*	13F	2F	14L	2F	14L	2F
15	*	*	24F	2F	15L	2F	15L	*

* No conversion shall be made for these positions and the signal/character shall be removed from the data.

Example: To find the ITA-2 signal to which the character 3/6 of IA-5 is to be converted, look at column 3, row 6. 25F means figure case of signal No. 25 (L = letter case, FL = either case designation).

Note 1. — The character 0/3 (ETX) shall convert to the ITA-2 sequence signals 14L, 14L, 14L, 14L (NNNN).

Note 2. — The signal 0/7 (BEL) shall only be converted when a sequence of 5 occurrences is detected, which shall convert to the ITA-2 sequence signals 30, 10F, 10F, 10F, 10F, 29.

Note 3. — The character sequence CR CR LF VT (0/11) ETX (0/3) shall convert to the ITA-2 sequence signals 29, 27, 27, 28, 28, 28, 28, 28, 28, 28, 28, 28, 14L, 14L, 14L, 14L.

Note 4. — To prevent redundant generation of figure and letter characters in ITA-2 when converting from IA-5, no case designation shall be assigned to ITA-2 non-printing functions (signals No. 27, 28, 29, 30, 31).

Note 5. — The character 0/1 (SOH) shall convert to the ITA-2 sequence signals 26L, 3L, 26L, 3L (ZCZC).

Table 8-5. Control field formats

Control field format for	Control field bits							
	1	2	3	4	5	6	7	8
Information transfer (I frame)	0	$N(S)$			P	$N(R)$		
Supervisory commands/responses (S frame)	1	0	S	S	P/F	$N(R)$		
Unnumbered commands/responses	1	1	M	M	P/F	M	M	M
<p>where:</p> <p>$N(S)$ = send sequence count (bit 2 = low order bit) $N(R)$ = receive sequence count (bit 6 = low order bit) S = supervisory function bits M = modifier function bits P = poll bit (in commands) F = final bit (in responses)</p>								

Table 8-6. Commands and responses

Type	Commands	Responses	<i>C field encoding</i>							
			1	2	3	4	5	6	7	8
Information transfer	I (information)		0	$N(S)$			P	$N(R)$		
Supervisory	RR (receive ready)	RR (receive ready)	1	0	0	0	P/F	$N(R)$		
	RNR (receive not ready)	RNR (receive not ready)	1	0	1	0	P/F	$N(R)$		
	REJ (reject)	REJ (reject)	1	0	0	1	P/F	$N(R)$		
Unnumbered		DM (disconnected mode)	1	1	1	1	P/F	0	0	0
	SABM (set asynchronous balanced mode)		1	1	1	1	P	1	0	0
	DISC (disconnect)		1	1	0	0	P	0	1	0
		UA (unnumbered acknowledgement)	1	1	0	0	F	1	1	0
		FRMR (frame reject)	1	1	1	0	F	0	0	1

FIGURES FOR CHAPTER 8

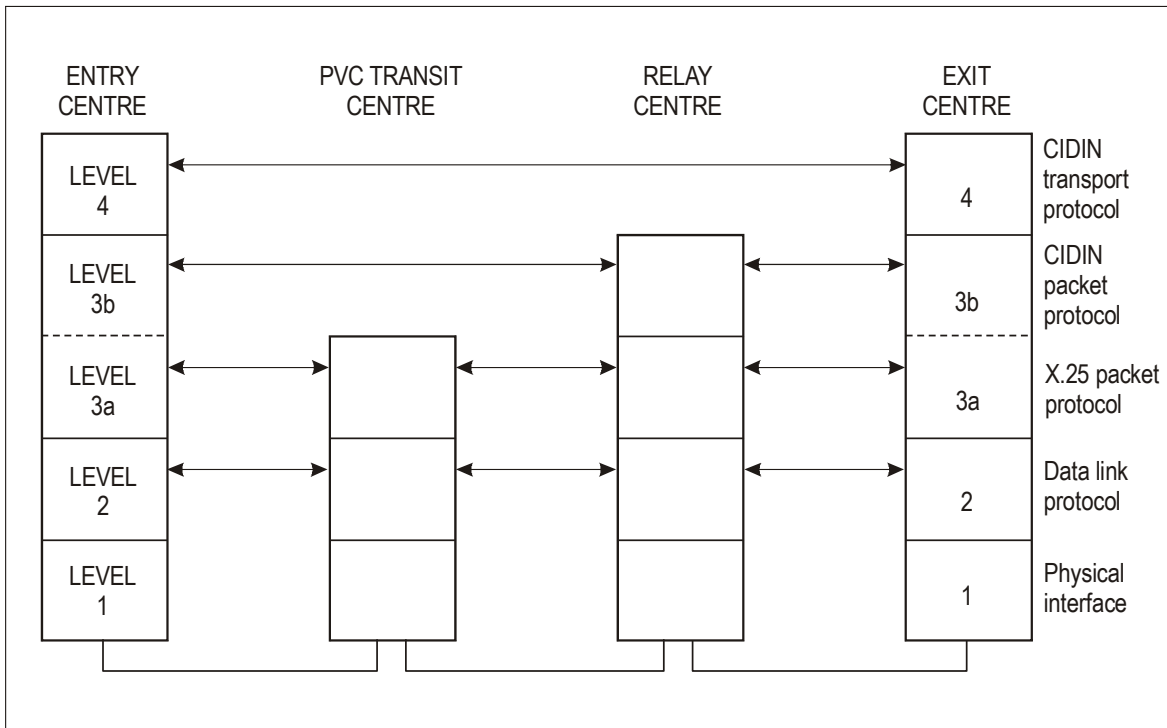

Figure 8-1. CIDIN protocol levels

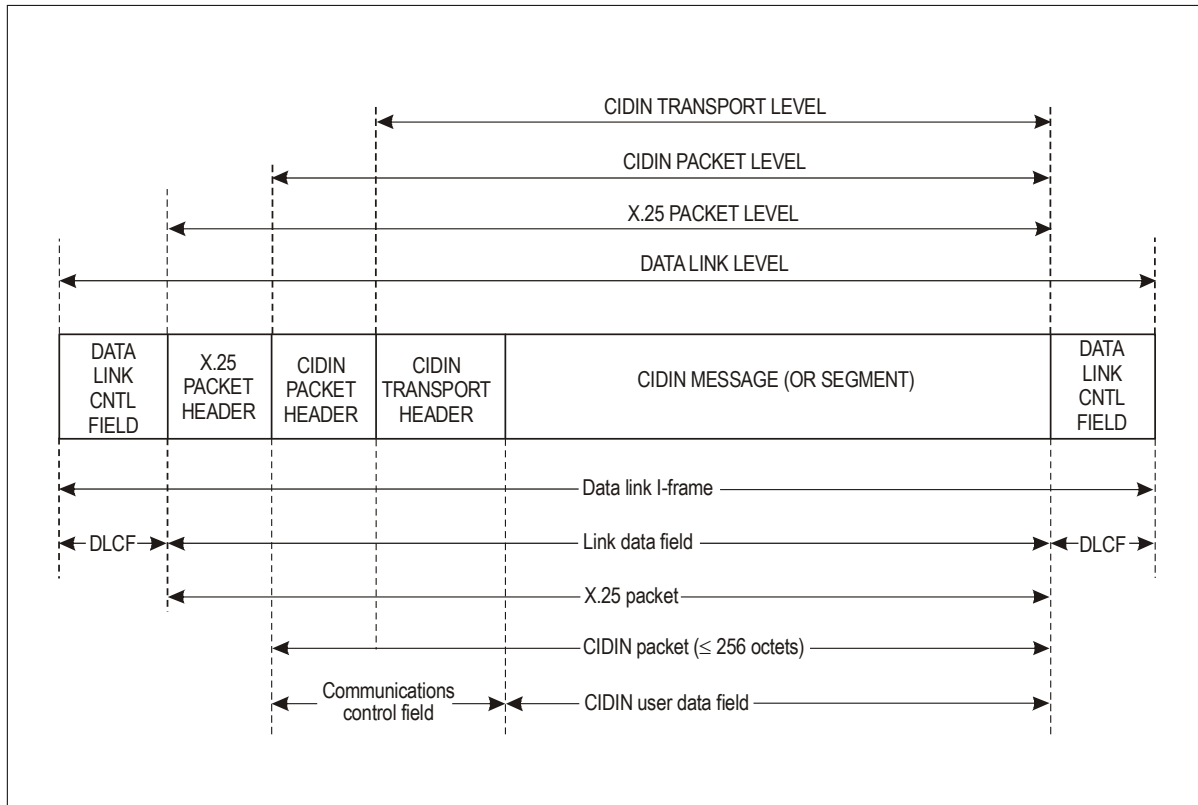

Figure 8-2. CIDIN terminology

CHAPTER 9. AIRCRAFT ADDRESSING SYSTEM

9.1 The aircraft address shall be one of 16 777 214 twenty-four-bit aircraft addresses allocated by ICAO to the State of Registry or common mark registering authority and assigned as prescribed in the Appendix to this chapter.

9.1.1 Non-aircraft transponders that are installed on aerodrome surface vehicles, obstacles or fixed Mode S target detection devices for surveillance and/or radar monitoring purposes shall be assigned 24-bit aircraft addresses.

Note.— Under such specific conditions, the term “aircraft” can be understood as “aircraft (or pseudo-aircraft) or vehicle (A/V)” where a limited set of data is generally sufficient for operational purposes.

9.1.1.1 **Recommendation.**— *Mode S transponders used under specific conditions stated in 9.1.1 should not have any negative impact on the performance of existing ATS surveillance systems and ACAS.*

**APPENDIX TO CHAPTER 9. A WORLDWIDE SCHEME FOR
THE ALLOCATION, ASSIGNMENT AND
APPLICATION OF AIRCRAFT ADDRESSES**

1. GENERAL

1.1 Global communications, navigation and surveillance systems shall use an individual aircraft address composed of 24 bits. At any one time, no address shall be assigned to more than one aircraft. The assignment of aircraft addresses requires a comprehensive scheme providing for a balanced and expandable distribution of aircraft addresses applicable worldwide.

2. DESCRIPTION OF THE SCHEME

2.1 Table 9-1 provides for blocks of consecutive addresses available to States for assignment to aircraft. Each block is defined by a fixed pattern of the first 4, 6, 9, 12 or 14 bits of the 24-bit address. Thus, blocks of different sizes (1 048 576, 262 144, 32 768, 4 096 and 1 024 consecutive addresses, respectively) are made available.

3. MANAGEMENT OF THE SCHEME

3.1 The International Civil Aviation Organization (ICAO) shall administer the scheme so that appropriate international distribution of aircraft addresses can be maintained.

4. ALLOCATION OF AIRCRAFT ADDRESSES

4.1 Blocks of aircraft addresses shall be allocated by ICAO to the State of Registry or common mark registering authority. Address allocations to States shall be as shown in Table 9-1.

4.2 A State of Registry or common mark registering authority shall notify ICAO when allocation to that State of an additional block of addresses is required for assignment to aircraft.

4.3 In the future management of the scheme, advantage shall be taken of the blocks of aircraft addresses not yet allocated. These spare blocks shall be distributed on the basis of the relevant ICAO region:

Addresses starting with bit combination 00100: AFI region

Addresses starting with bit combination 00101: SAM region

Addresses starting with bit combination 0101: EUR and NAT regions

Addresses starting with bit combination 01100: MID region

Addresses starting with bit combination 01101: ASIA region

Addresses starting with bit combination 1001: NAM and PAC regions

Addresses starting with bit combination 111011: CAR region

In addition, aircraft addresses starting with bit combinations 1011, 1101 and 1111 have been reserved for future use.

4.4 Any future requirement for additional aircraft addresses shall be accommodated through coordination between ICAO and the States of Registry or common mark registering authority concerned. A request for additional aircraft addresses shall only be made by a registering authority when at least 75 per cent of the number of addresses already allocated to that registering authority have been assigned to aircraft.

4.5 ICAO shall allocate blocks of aircraft addresses to non-Contracting States upon request.

5. ASSIGNMENT OF AIRCRAFT ADDRESSES

5.1 Using its allocated block of addresses, the State of Registry or common mark registering authority shall assign an individual aircraft address to each suitably equipped aircraft entered on a national or international register (Table 9-1).

Note.— For an aircraft delivery, the aircraft operator is expected to inform the airframe manufacturer of an address assignment. The airframe manufacturer or other organization responsible for a delivery flight is expected to ensure installation of a correctly assigned address supplied by the State of Registry or common mark registering authority. Exceptionally, a temporary address may be supplied under the arrangements detailed in paragraph 7.

5.2 Aircraft addresses shall be assigned to aircraft in accordance with the following principles:

- a) at any one time, no address shall be assigned to more than one aircraft with the exception of aerodrome surface vehicles on surface movement areas. If such exceptions are applied by the State of Registry, the vehicles which have been allocated the same address shall not operate on aerodromes separated by less than 1 000 km;
- b) only one address shall be assigned to an aircraft, irrespective of the composition of equipment on board. In the case when a removable transponder is shared by several light aviation aircraft such as balloons or gliders, it shall be possible to assign a unique address to the removable transponder. The registers 08₁₆, 20₁₆, 21₁₆, 22₁₆ and 25₁₆ of the removable transponder shall be correctly updated each time the removable transponder is installed in any aircraft;
- c) the address shall not be changed except under exceptional circumstances and shall not be changed during flight;
- d) when an aircraft changes its State of Registry, the new registering State shall assign the aircraft a new address from its own allocation address block, and the old aircraft address shall be returned to the allocation address block of the State that previously registered the aircraft;
- e) the address shall serve only a technical role for addressing and identification of aircraft and shall not be used to convey any specific information; and
- f) the addresses composed of 24 ZEROS or 24 ONES shall not be assigned to aircraft.

5.2.1 **Recommendation.**— *Any method used to assign aircraft addresses should ensure efficient use of the entire address block that is allocated to that State.*

6. APPLICATION OF AIRCRAFT ADDRESSES

6.1 The aircraft addresses shall be used in applications which require the routing of information to or from individual suitably equipped aircraft.

Note 1.— Examples of such applications are the aeronautical telecommunication network (ATN), SSR Mode S and airborne collision avoidance system (ACAS).

Note 2.— This Standard does not preclude assigning the aircraft addresses for special applications associated with the general applications defined therein. Examples of such special applications are the utilization of the 24-bit address in a pseudo-aeronautical earth station to monitor the aeronautical mobile-satellite service ground earth station and in the fixed Mode S transponders (reporting the on-the-ground status as specified in Annex 10, Volume IV, 3.1.2.6.10.1.2) to monitor the Mode S ground station operation. Address assignments for special applications are to be carried out in conformance with the procedure established by the State to manage the 24-bit address assignments to aircraft.

6.2 An address consisting of 24 ZEROs shall not be used for any application.

7. ADMINISTRATION OF THE TEMPORARY AIRCRAFT ADDRESS ASSIGNMENTS

7.1 Temporary addresses shall be assigned to aircraft in exceptional circumstances, such as when operators have been unable to obtain an address from their individual States of Registry or Common Mark Registering Authority in a timely manner. ICAO shall assign temporary addresses from the block “ICAO¹” shown in Table 9-1.

7.2 When requesting a temporary address, the aircraft operator shall supply to ICAO: aircraft identification, type and make of aircraft, name and address of the operator, and an explanation of the reason for the request.

7.2.1 Upon issuance of the temporary address to the aircraft operators, ICAO shall inform the State of Registry of the issuance of the temporary address, reason and duration.

7.3 The aircraft operator shall:

- a) inform the State of Registry of the temporary assignment and reiterate the request for a permanent address; and
- b) inform the airframe manufacturer.

7.4 When the permanent aircraft address is obtained from the State of Registry, the operator shall:

- a) inform ICAO without delay;
- b) relinquish his/her temporary address; and
- c) arrange for encoding of the valid unique address within 180 calendar days.

7.5 If a permanent address is not obtained within one year, the aircraft operator shall reapply for a new temporary aircraft address. Under no circumstances shall a temporary aircraft address be used by the aircraft operator for over one year.

Table 9-1. Allocation of aircraft addresses to States

Note.— The left-hand column of the 24-bit address patterns represents the most significant bit (MSB) of the address.

State	Number of addresses in block					Allocation of blocks of addresses (a dash represents a bit value equal to 0 or 1)					
	1 024	4 096	32 768	262 144	1 048 576						
Afghanistan		*				0 1 1 1	0 0	0 0 0	0 0 0	--	-----
Albania	*					0 1 0 1	0 0	0 0 0	0 0 1	0 0	-----
Algeria			*			0 0 0 0	1 0	1 0 0	---	--	-----
Angola		*				0 0 0 0	1 0	0 1 0	0 0 0	--	-----
Antigua and Barbuda	*					0 0 0 0	1 1	0 0 1	0 1 0	0 0	-----
Argentina				*		1 1 1 0	0 0	---	---	--	-----
Armenia	*					0 1 1 0	0 0	0 0 0	0 0 0	0 0	-----
Australia				*		0 1 1 1	1 1	---	---	--	-----
Austria			*			0 1 0 0	0 1	0 0 0	---	--	-----
Azerbaijan	*					0 1 1 0	0 0	0 0 0	0 0 0	1 0	-----
Bahamas		*				0 0 0 0	1 0	1 0 1	0 0 0	--	-----
Bahrain		*				1 0 0 0	1 0	0 1 0	1 0 0	--	-----
Bangladesh		*				0 1 1 1	0 0	0 0 0	0 1 0	--	-----
Barbados	*					0 0 0 0	1 0	1 0 1	0 1 0	0 0	-----
Belarus	*					0 1 0 1	0 0	0 1 0	0 0 0	0 0	-----
Belgium			*			0 1 0 0	0 1	0 0 1	---	--	-----
Belize	*					0 0 0 0	1 0	1 0 1	0 1 1	0 0	-----
Benin	*					0 0 0 0	1 0	0 1 0	1 0 0	0 0	-----
Bhutan	*					0 1 1 0	1 0	0 0 0	0 0 0	0 0	-----
Bolivia		*				1 1 1 0	1 0	0 1 0	1 0 0	--	-----
Bosnia and Herzegovina	*					0 1 0 1	0 0	0 1 0	0 1 1	0 0	-----
Botswana	*					0 0 0 0	0 0	1 1 0	0 0 0	0 0	-----
Brazil				*		1 1 1 0	0 1	---	---	--	-----
Brunei Darussalam	*					1 0 0 0	1 0	0 1 0	1 0 1	0 0	-----
Bulgaria			*			0 1 0 0	0 1	0 1 0	---	--	-----
Burkina Faso		*				0 0 0 0	1 0	0 1 1	1 0 0	--	-----
Burundi		*				0 0 0 0	0 0	1 1 0	0 1 0	--	-----
Cambodia		*				0 1 1 1	0 0	0 0 1	1 1 0	--	-----
Cameroon		*				0 0 0 0	0 0	1 1 0	1 0 0	--	-----
Canada				*		1 1 0 0	0 0	---	---	--	-----
Cape Verde	*					0 0 0 0	1 0	0 1 0	1 1 0	0 0	-----
Central African Republic		*				0 0 0 0	0 1	1 0 1	1 0 0	--	-----
Chad		*				0 0 0 0	1 0	0 0 0	1 0 0	--	-----
Chile		*				1 1 1 0	1 0	0 0 0	0 0 0	--	-----
China				*		0 1 1 1	1 0	---	---	--	-----
Colombia		*				0 0 0 0	1 0	1 0 1	1 0 0	--	-----
Comoros	*					0 0 0 0	0 0	1 1 0	1 0 1	0 0	-----
Congo		*				0 0 0 0	0 0	1 1 0	1 1 0	--	-----
Cook Islands	*					1 0 0 1	0 0	0 0 0	0 0 1	0 0	-----
Costa Rica		*				0 0 0 0	1 0	1 0 1	1 1 0	--	-----
Côte d'Ivoire		*				0 0 0 0	0 0	1 1 1	0 0 0	--	-----
Croatia	*					0 1 0 1	0 0	0 0 0	0 0 1	1 1	-----
Cuba		*				0 0 0 0	1 0	1 1 0	0 0 0	--	-----
Cyprus	*					0 1 0 0	1 1	0 0 1	0 0 0	0 0	-----
Czech Republic			*			0 1 0 0	1 0	0 1 1	---	--	-----

State	Number of addresses in block					Allocation of blocks of addresses (a dash represents a bit value equal to 0 or 1)					
	1 024	4 096	32 768	262 144	1 048 576						
Democratic People's Republic of Korea			*			0 1 1 1	0 0	1 0 0	---	--	-----
Democratic Republic of the Congo		*				0 0 0 0	1 0	0 0 1	1 0 0	--	-----
Denmark			*			0 1 0 0	0 1	0 1 1	---	--	-----
Djibouti	*					0 0 0 0	1 0	0 1 1	0 0 0	0 0	-----
Dominican Republic		*				0 0 0 0	1 1	0 0 0	1 0 0	--	-----
Ecuador		*				1 1 1 0	1 0	0 0 0	1 0 0	--	-----
Egypt			*			0 0 0 0	0 0	0 1 0	---	--	-----
El Salvador		*				0 0 0 0	1 0	1 1 0	0 1 0	--	-----
Equatorial Guinea		*				0 0 0 0	0 1	0 0 0	0 1 0	--	-----
Eritrea	*					0 0 1 0	0 0	0 0 0	0 1 0	0 0	-----
Estonia	*					0 1 0 1	0 0	0 1 0	0 0 1	0 0	-----
Ethiopia		*				0 0 0 0	0 1	0 0 0	0 0 0	--	-----
Fiji		*				1 1 0 0	1 0	0 0 1	0 0 0	--	-----
Finland			*			0 1 0 0	0 1	1 0 0	---	--	-----
France				*		0 0 1 1	1 0	---	---	--	-----
Gabon		*				0 0 0 0	0 0	1 1 1	1 1 0	--	-----
Gambia		*				0 0 0 0	1 0	0 1 1	0 1 0	--	-----
Georgia	*					0 1 0 1	0 0	0 1 0	1 0 0	0 0	-----
Germany				*		0 0 1 1	1 1	---	---	--	-----
Ghana		*				0 0 0 0	0 1	0 0 0	1 0 0	--	-----
Greece			*			0 1 0 0	0 1	1 0 1	---	--	-----
Grenada	*					0 0 0 0	1 1	0 0 1	1 0 0	0 0	-----
Guatemala		*				0 0 0 0	1 0	1 1 0	1 0 0	--	-----
Guinea		*				0 0 0 0	0 1	0 0 0	1 1 0	--	-----
Guinea-Bissau	*					0 0 0 0	0 1	0 0 1	0 0 0	0 0	-----
Guyana		*				0 0 0 0	1 0	1 1 0	1 1 0	--	-----
Haiti		*				0 0 0 0	1 0	1 1 1	0 0 0	--	-----
Honduras		*				0 0 0 0	1 0	1 1 1	0 1 0	--	-----
Hungary			*			0 1 0 0	0 1	1 1 0	---	--	-----
Iceland		*				0 1 0 0	1 1	0 0 1	1 0 0	--	-----
India				*		1 0 0 0	0 0	---	---	--	-----
Indonesia			*			1 0 0 0	1 0	1 0 0	---	--	-----
Iran, Islamic Republic of			*			0 1 1 1	0 0	1 1 0	---	--	-----
Iraq			*			0 1 1 1	0 0	1 0 1	---	--	-----
Ireland		*				0 1 0 0	1 1	0 0 1	0 1 0	--	-----
Israel			*			0 1 1 1	0 0	1 1 1	---	--	-----
Italy				*		0 0 1 1	0 0	---	---	--	-----
Jamaica		*				0 0 0 0	1 0	1 1 1	1 1 0	--	-----
Japan				*		1 0 0 0	0 1	---	---	--	-----
Jordan			*			0 1 1 1	0 1	0 0 0	---	--	-----
Kazakhstan	*					0 1 1 0	1 0	0 0 0	0 1 1	0 0	-----
Kenya		*				0 0 0 0	0 1	0 0 1	1 0 0	--	-----
Kiribati	*					1 1 0 0	1 0	0 0 1	1 1 0	0 0	-----
Kuwait		*				0 1 1 1	0 0	0 0 0	1 1 0	--	-----
Kyrgyzstan	*					0 1 1 0	0 0	0 0 0	0 0 1	0 0	-----
Lao People's Democratic Republic		*				0 1 1 1	0 0	0 0 1	0 0 0	--	-----
Latvia	*					0 1 0 1	0 0	0 0 0	0 1 0	1 1	-----

State	Number of addresses in block					Allocation of blocks of addresses (a dash represents a bit value equal to 0 or 1)					
	1 024	4 096	32 768	262 144	1 048 576						
Lebanon			*			0 1 1 1	0 1	0 0 1	---	--	-----
Lesotho	*					0 0 0 0	0 1	0 0 1	0 1 0	0 0	-----
Liberia		*				0 0 0 0	0 1	0 1 0	0 0 0	--	-----
Libyan Arab Jamahiriya			*			0 0 0 0	0 0	0 1 1	---	--	-----
Lithuania	*					0 1 0 1	0 0	0 0 0	0 1 1	1 1	-----
Luxembourg	*					0 1 0 0	1 1	0 1 0	0 0 0	0 0	-----
Madagascar		*				0 0 0 0	0 1	0 1 0	1 0 0	--	-----
Malawi		*				0 0 0 0	0 1	0 1 1	0 0 0	--	-----
Malaysia			*			0 1 1 1	0 1	0 1 0	---	--	-----
Maldives	*					0 0 0 0	0 1	0 1 1	0 1 0	0 0	-----
Mali		*				0 0 0 0	0 1	0 1 1	1 0 0	--	-----
Malta	*					0 1 0 0	1 1	0 1 0	0 1 0	0 0	-----
Marshall Islands	*					1 0 0 1	0 0	0 0 0	0 0 0	0 0	-----
Mauritania	*					0 0 0 0	0 1	0 1 1	1 1 0	0 0	-----
Mauritius	*					0 0 0 0	0 1	1 0 0	0 0 0	0 0	-----
Mexico			*			0 0 0 0	1 1	0 1 0	---	--	-----
Micronesia, Federated States of	*					0 1 1 0	1 0	0 0 0	0 0 1	0 0	-----
Monaco	*					0 1 0 0	1 1	0 1 0	1 0 0	0 0	-----
Mongolia	*					0 1 1 0	1 0	0 0 0	0 1 0	0 0	-----
Montenegro	*					0 1 0 1	0 0	0 1 0	1 1 0	0 0	-----
Morocco			*			0 0 0 0	0 0	1 0 0	---	--	-----
Mozambique		*				0 0 0 0	0 0	0 0 0	1 1 0	--	-----
Myanmar		*				0 1 1 1	0 0	0 0 0	1 0 0	--	-----
Namibia	*					0 0 1 0	0 0	0 0 0	0 0 1	0 0	-----
Nauru	*					1 1 0 0	1 0	0 0 1	0 1 0	0 0	-----
Nepal		*				0 1 1 1	0 0	0 0 1	0 1 0	--	-----
Netherlands, Kingdom of the			*			0 1 0 0	1 0	0 0 0	---	--	-----
New Zealand			*			1 1 0 0	1 0	0 0 0	---	--	-----
Nicaragua		*				0 0 0 0	1 1	0 0 0	0 0 0	--	-----
Niger		*				0 0 0 0	0 1	1 0 0	0 1 0	--	-----
Nigeria		*				0 0 0 0	0 1	1 0 0	1 0 0	--	-----
Norway			*			0 1 0 0	0 1	1 1 1	---	--	-----
Oman	*					0 1 1 1	0 0	0 0 1	1 0 0	0 0	-----
Pakistan			*			0 1 1 1	0 1	1 0 0	---	--	-----
Palau	*					0 1 1 0	1 0	0 0 0	1 0 0	0 0	-----
Panama		*				0 0 0 0	1 1	0 0 0	0 1 0	--	-----
Papua New Guinea		*				1 0 0 0	1 0	0 1 1	0 0 0	--	-----
Paraguay		*				1 1 1 0	1 0	0 0 1	0 0 0	--	-----
Peru		*				1 1 1 0	1 0	0 0 1	1 0 0	--	-----
Philippines			*			0 1 1 1	0 1	0 1 1	---	--	-----
Poland			*			0 1 0 0	1 0	0 0 1	---	--	-----
Portugal			*			0 1 0 0	1 0	0 1 0	---	--	-----
Qatar	*					0 0 0 0	0 1	1 0 1	0 1 0	0 0	-----
Republic of Korea			*			0 1 1 1	0 0	0 1 1	---	--	-----
Republic of Moldova	*					0 1 0 1	0 0	0 0 0	1 0 0	1 1	-----
Romania			*			0 1 0 0	1 0	1 0 0	---	--	-----
Russian Federation				*		0 0 0 1	--	---	---	--	-----
Rwanda		*				0 0 0 0	0 1	1 0 1	1 1 0	--	-----

State	Number of addresses in block					Allocation of blocks of addresses (a dash represents a bit value equal to 0 or 1)					
	1 024	4 096	32 768	262 144	1 048 576						
Saint Lucia	*					1 100	10	001	100	00	-----
Saint Vincent and the Grenadines	*					0000	10	111	100	00	-----
Samoa	*					1001	00	000	010	00	-----
San Marino	*					0101	00	000	000	00	-----
Sao Tome and Principe	*					0000	10	011	110	00	-----
Saudi Arabia			*			0111	00	010	---	--	-----
Senegal		*				0000	01	110	000	--	-----
Serbia			*			0100	11	000	---	--	-----
Seychelles	*					0000	01	110	100	00	-----
Sierra Leone	*					0000	01	110	110	00	-----
Singapore			*			0111	01	101	---	--	-----
Slovakia	*					0101	00	000	101	11	-----
Slovenia	*					0101	00	000	110	11	-----
Solomon Islands	*					1000	10	010	111	00	-----
Somalia		*				0000	01	111	000	--	-----
South Africa			*			0000	00	001	---	--	-----
Spain				*		0011	01	---	---	--	-----
Sri Lanka			*			0111	01	110	---	--	-----
Sudan		*				0000	01	111	100	--	-----
Suriname		*				0000	11	001	000	--	-----
Swaziland	*					0000	01	111	010	00	-----
Sweden			*			0100	10	101	---	--	-----
Switzerland			*			0100	10	110	---	--	-----
Syrian Arab Republic			*			0111	01	111	---	--	-----
Tajikistan	*					0101	00	010	101	00	-----
Thailand			*			1000	10	000	---	--	-----
The former Yugoslav Republic of Macedonia	*					0101	00	010	010	00	-----
Togo		*				0000	10	001	000	--	-----
Tonga	*					1100	10	001	101	00	-----
Trinidad and Tobago		*				0000	11	000	110	--	-----
Tunisia			*			0000	00	101	---	--	-----
Turkey			*			0100	10	111	---	--	-----
Turkmenistan	*					0110	00	000	001	10	-----
Uganda		*				0000	01	101	000	--	-----
Ukraine			*			0101	00	001	---	--	-----
United Arab Emirates		*				1000	10	010	110	--	-----
United Kingdom				*		0100	00	---	---	--	-----
United Republic of Tanzania		*				0000	10	000	000	--	-----
United States					*	1010	--	---	---	--	-----
Uruguay		*				1110	10	010	000	--	-----
Uzbekistan	*					0101	00	000	111	11	-----
Vanuatu	*					1100	10	010	000	00	-----
Venezuela			*			0000	11	011	---	--	-----
Viet Nam			*			1000	10	001	---	--	-----
Yemen		*				1000	10	010	000	--	-----
Zambia		*				0000	10	001	010	--	-----
Zimbabwe	*					0000	00	000	100	00	-----

State	Number of addresses in block					Allocation of blocks of addresses (a dash represents a bit value equal to 0 or 1)					
	1 024	4 096	32 768	262 144	1 048 576						
Other allocations											
ICAO ¹			*			1 1 1 1	0 0	0 0 0	---	--	-----
ICAO ²	*					1 0 0 0	1 0	0 1 1	0 0 1	0 0	-----
ICAO ²	*					1 1 1 1	0 0	0 0 1	0 0 1	0 0	-----
<p>1. ICAO administers this block for assigning temporary aircraft addresses as described in section 7.</p> <p>2. Block allocated for special use in the interest of flight safety.</p>											

CHAPTER 10. POINT-TO-MULTIPOINT COMMUNICATIONS

10.1 SERVICE VIA SATELLITE FOR THE DISSEMINATION OF AERONAUTICAL INFORMATION

10.1.1 Point-to-multipoint telecommunication service via satellite to support the dissemination of aeronautical information shall be based on full-time, non pre-emptible, protected services as defined in the relevant CCITT Recommendations.

10.2 SERVICE VIA SATELLITE FOR THE DISSEMINATION OF WAFS PRODUCTS

10.2.1 **Recommendation.**— *System characteristics should include the following:*

- a) frequency — C-band, earth-to-satellite, 6 GHz band, satellite-to-earth, 4 GHz band;*
 - b) capacity with effective signalling rate of not less than 9 600 bits/s;*
 - c) bit error rates — better than 1 in 10^7 ;*
 - d) forward error correction; and*
 - e) availability 99.95 per cent.*
-

CHAPTER 11. HF DATA LINK

11.1 DEFINITIONS AND SYSTEM CAPABILITIES

Note.— The following Standards and Recommended Practices are specific to the high frequency data link (HF DL) and are in addition to the requirements specified in the ITU Radio Regulations (Appendix 27). The HF DL is a constituent mobile subnetwork of the aeronautical telecommunication network (ATN), operating in the aeronautical mobile (R) high frequency bands. In addition, the HF DL may provide non-ATN functions, such as direct link service (DLS). The HF DL system must enable aircraft to exchange data with ground-based users.

11.1.1 Definitions

Coded chip. A “1” or “0” output of the rate $\frac{1}{2}$ or $\frac{1}{4}$ convolutional code encoder.

Designated operational coverage (DOC) area. The area in which a particular service is provided and in which the service is afforded frequency protection.

Note.— This area may, after proper coordination to ensure frequency protection, extend to areas outside the allotment areas contained in Appendix S27 to the Radio Regulations.

Direct link service (DLS). A data communications service which makes no attempt to automatically correct errors, detected or undetected, at the link layer of the air-ground communications path. (Error control may be effected by end-user systems.)

High frequency network protocol data unit (HFNPDU). User data packet.

Link protocol data unit (LPDU). Data unit which encapsulates a segment of an HFNPDU.

M-ary phase shift keying (M-PSK) modulation. A digital phase modulation that causes the phase of the carrier waveform to take on one of a set of M values.

Media access protocol data unit (MPDU). Data unit which encapsulates one or more LPDUs.

M-PSK symbol. One of the M possible phase shifts of the M-PSK modulated carrier representing a group of $\log_2 M$ coded chips.

Peak envelope power (PEP). The peak power of the modulated signal supplied by the transmitter to the antenna transmission line.

Physical layer protocol data unit (PPDU). Data unit passed to the physical layer for transmission, or decoded by the physical layer after reception.

Quality of service (QoS). The information relating to data transfer characteristics used by various communications protocols to achieve various levels of performance for network users.

Reliable link service (RLS). A data communications service provided by the subnetwork which automatically provides for error control over its link through error detection and requested retransmission of signal units found to be in error.

Squitter protocol data unit (SPDU). Data packet which is broadcast every 32 seconds by an HF DL ground station on each of its operating frequencies, and which contains link management information.

11.2 HF DATA LINK SYSTEM

11.2.1 System architecture

The HF DL system shall consist of one or more ground and aircraft station subsystems, which implement the HF DL protocol (see 11.3). The HF DL system shall also include a ground management subsystem (see 11.4).

11.2.1.1 AIRCRAFT AND GROUND STATION SUBSYSTEMS

The HF DL aircraft station subsystem and the HF DL ground station subsystem shall include the following functions:

- a) HF transmission and reception;
- b) data modulation and demodulation; and
- c) HF DL protocol implementation and frequency selection.

11.2.2 Operational coverage

Frequency assignments for HF DL shall be protected throughout their designated operational coverage (DOC) area.

Note 1.— DOC areas may be different from current MWARAs or RDARAs as defined in Appendix 27 to the ITU Radio Regulations.

Note 2.— Additional coordination with ITU is required in cases where DOC areas are not in conformity with the allotment areas specified in the ITU Radio Regulations.

11.2.3 Requirements for carriage of HF DL equipment

Requirements for mandatory carriage of HF DL equipment shall be made on the basis of regional air navigation agreements that specify the airspace of operation and the implementation timescale.

11.2.3.1 NOTICE

The agreement above shall provide advance notice of at least two years for the mandatory carriage of airborne systems.

11.2.4 Ground station networking

11.2.4.1 **Recommendation.**— *HF DL ground station subsystems should interconnect through a common ground management subsystem.*

Note.— This provides a distributed subnetwork, with a subnetwork point of attachment (SNPA), depending on the method of implementation, which allows for the maintenance of virtual circuit connections as aircraft stations transition between designated operational coverage areas. The distribution may be multi-regional or worldwide.

11.2.5 Ground station synchronization

Synchronization of HF DL ground station subsystems shall be to within ± 25 ms of UTC. For any station not operating within ± 25 ms of UTC, appropriate notification shall be made to all aircraft and ground station subsystems to allow for continued system operation.

11.2.6 Quality of service

11.2.6.1 RESIDUAL PACKET ERROR RATE

The undetected error rate for a network user packet which contains between 1 and 128 octets of user data shall be equal to or less than 1 in 10^6 .

11.2.6.2 SPEED OF SERVICE

Transit and transfer delays for network user packets (128 octets) with priorities defined in Part I, Chapter 4, Table 4-26 for message priorities 7 through 14, shall not exceed the values of Table 11-1*.

11.3 HF DATA LINK PROTOCOL

The HF DL protocol shall consist of a physical layer, a link layer, and a subnetwork layer, as specified below.

Note.— The HF DL protocol is a layered protocol and is compatible with the open systems interconnection (OSI) reference model. It permits the HF DL to function as an aeronautical telecommunication network (ATN)-compatible subnetwork. The details of the protocol are described in the Manual on HF Data Link (Doc 9741).

11.3.1 Physical layer RF characteristics

The aircraft and ground stations shall access the physical medium operating in simplex mode.

11.3.1.1 FREQUENCY BANDS

HF DL installations shall be capable of operating at any single sideband (SSB) carrier (reference) frequency available to the aeronautical mobile (R) service in the band 2.8 to 22 MHz, and in compliance with the relevant provisions of the Radio Regulations.

* All tables and figures are located at the end of this chapter.

11.3.1.2 CHANNELS

Channel utilization shall be in conformity with the table of carrier (reference) frequencies of Appendix 27 to the ITU Radio Regulations.

11.3.1.3 TUNING

The equipment shall be capable of operating on integral multiples of 1 kHz.

11.3.1.4 SIDEBAND

The sideband used for transmission shall be on the higher side of its carrier (reference) frequency.

11.3.1.5 MODULATION

HF DL shall employ M-ary phase shift keying (M-PSK) to modulate the radio frequency carrier at the assigned frequency. The symbol rate shall be 1 800 symbols per second ± 10 parts per million (i.e. 0.018 symbols per second). The value of M and the information data rate shall be as specified in Table 11-2.

11.3.1.5.1 M-PSK CARRIER

The M-PSK carrier expressed mathematically shall be defined as:

$$s(t) = A \sum (p(t-kT) \cos[2\pi f_0 t + \varphi(k)]), k = 0, 1, \dots, N-1$$

where:

N	=	number of M-PSK symbols in transmitted physical layer protocol data unit (PPDU)
s(t)	=	analog waveform or signal at time t
A	=	peak amplitude
f ₀	=	SSB carrier (reference) + 1 440 Hz
T	=	M-PSK symbol period (1/1 800 s)
φ(k)	=	phase of kth M-PSK symbol
p(t-kT)	=	pulse shape of kth M-PSK symbol at time t.

Note.— The number of M-PSK symbols sent, N, defines the length (duration = NT seconds) of the PPDU. These parameters are defined in the Manual on HF Data Link (Doc 9741).

11.3.1.5.2 PULSE SHAPE

The pulse shape, p(t), shall determine the spectral distribution of the transmitted signal. The Fourier transform of the pulse shape, P(f), shall be defined by:

$$\begin{aligned}
 P(f) &= 1, & \text{if } 0 < |f| < (1 - b)/2T \\
 P(f) &= \cos \{ \pi(2|f|T - 1 + b)/4b \}, & \text{if } (1 - b)/2T < |f| < (1 + b)/2T \\
 P(f) &= 0, & \text{if } |f| > (1 + b)/2T
 \end{aligned}$$

where the spectral roll-off parameter, b = 0.31, has been chosen so that the -20 dB points of the signal are at SSB carrier (reference) + 290 Hz and SSB carrier (reference) + 2 590 Hz and the peak-to-average power ratio of the waveform is less than 5 dB.

11.3.1.6 TRANSMITTER STABILITY

The basic frequency stability of the transmitting function shall be better than:

- a) ± 20 Hz for HFDL aircraft station subsystems; and
- b) ± 10 Hz for HFDL ground station subsystems.

11.3.1.7 RECEIVER STABILITY

The basic frequency stability of the receiving function shall be such that, with the transmitting function stability specified in 11.3.1.6, the overall frequency difference between ground and airborne functions achieved in service does not exceed 70 Hz.

11.3.1.8 PROTECTION

A 15 dB desired to undesired (D/U) signal ratio shall apply for the protection of co-channel assignments for HFDL as follows:

- a) data versus data;
- b) data versus voice; and
- c) voice versus data.

11.3.1.9 CLASS OF EMISSION

The class of emission shall be 2K80J2DEN.

11.3.1.10 ASSIGNED FREQUENCY

The HFDL assigned frequency shall be 1 400 Hz higher than the SSB carrier (reference) frequency.

Note.— By convention, the HFDL assigned frequency is offset from the SSB carrier (reference) frequency by 1 400 Hz. The HFDL M-PSK carrier of the digital modulation is offset from the SSB carrier (reference) frequency by 1 440 Hz. The digital modulation is fully contained within the same overall channel bandwidth as the voice signal and complies with the provisions of Appendix 27 to the ITU Radio Regulations.

11.3.1.11 EMISSION LIMITS

For HFDL aircraft and ground station transmitters, the peak envelope power (P_p) of any emission on any discrete frequency shall be less than the peak envelope power (P_p) of the transmitter in accordance with the following (see Figure 11-1):

- a) on any frequency between 1.5 kHz and 4.5 kHz lower than the HFDL assigned frequency, and on any frequency between 1.5 kHz and 4.5 kHz higher than the HFDL assigned frequency: at least 30 dB;
- b) on any frequency between 4.5 kHz and 7.5 kHz lower than the HFDL assigned frequency, and on any frequency between 4.5 kHz and 7.5 kHz higher than the HFDL assigned frequency: at least 38 dB; and

- c) on any frequency lower than 7.5 kHz below the HFDL assigned frequency and on any frequency higher than 7.5 kHz above the HFDL assigned frequency:
 - 1) HFDL aircraft station transmitters: 43 dB;
 - 2) HFDL ground station transmitters up to and including 50 W:
[43 + 10 log₁₀ P_p(W)] dB; and
 - 3) HFDL ground station transmitters more than 50 W: 60 dB.

11.3.1.12 POWER

11.3.1.12.1 *Ground station installations.* The peak envelope power (P_p) supplied to the antenna transmission line shall not exceed a maximum value of 6 kW as provided for in Appendix 27 of the Radio Regulations.

11.3.1.12.2 *Aircraft station installations.* The peak envelope power supplied to the antenna transmission line shall not exceed 400 W, except as provided for in Appendix 27/62 of the Radio Regulations.

11.3.1.13 UNDESIRE SIGNAL REJECTION

For HFDL aircraft and ground station receivers, undesired input signals shall be attenuated in accordance with the following:

- a) on any frequency between f_c and $(f_c - 300 \text{ Hz})$, or between $(f_c + 2\,900 \text{ Hz})$ and $(f_c + 3\,300 \text{ Hz})$: at least 35 dB below the peak of the desired signal level; and
- b) on any frequency below $(f_c - 300 \text{ Hz})$, or above $(f_c + 3\,300 \text{ Hz})$: at least 60 dB below the peak of the desired signal level,

where f_c is the carrier (reference) frequency.

11.3.1.14 RECEIVER RESPONSE TO TRANSIENTS

Recommendation.— *The receiving function should recover from an instantaneous increase in RF power at the antenna terminal of 60 dB within 10 milliseconds. The receiving function should recover from an instantaneous decrease in RF power at the antenna terminal of 60 dB within 25 milliseconds.*

11.3.2 Physical layer functions

11.3.2.1 FUNCTIONS

The functions provided by the physical layer shall include the following:

- a) transmitter and receiver control;
- b) transmission of data; and
- c) reception of data.

11.3.2.2 TRANSMITTER AND RECEIVER CONTROL

The HF DL physical layer shall implement the transmitter/receiver switching and frequency tuning as commanded by the link layer. The physical layer shall perform transmitter keying on demand from the link layer to transmit a packet.

11.3.2.2.1 *TRANSMITTER TO RECEIVER TURNAROUND TIME*

The transmitted power level shall decay at least by 10 dB within 100 milliseconds after completing a transmission. An HF DL station subsystem shall be capable of receiving and demodulating, with nominal performance, an incoming signal within 200 milliseconds of the start of the subsequent receive slot.

11.3.2.2.2 *RECEIVER TO TRANSMITTER TURNAROUND TIME*

An HF DL station subsystem shall provide nominal output power within plus or minus 1 dB to the antenna transmission line within 200 milliseconds of the start of the transmit slot.

11.3.2.3 TRANSMISSION OF DATA

Transmission of data shall be accomplished using a time division multiple access (TDMA) technique. The HF DL data link ground station subsystems shall maintain TDMA frame and slot synchronization for the HF DL system. To ensure that slot synchronization is maintained, each HF data link modulator shall begin outputting a pre-key segment at the beginning of a time slot plus or minus 10 milliseconds.

11.3.2.3.1 *TDMA STRUCTURE*

Each TDMA frame shall be 32 seconds. Each TDMA frame shall be divided into thirteen equal duration slots as follows:

- a) the first slot of each TDMA frame shall be reserved for use by the HF DL ground station subsystem to broadcast link management data in SPDU packets; and
- b) the remaining slots shall be designated either as uplink slots, downlink slots reserved for specific HF DL aircraft station subsystems, or as downlink random access slots for use by all HF DL aircraft station subsystems on a contention basis. These TDMA slots shall be assigned on a dynamic basis using a combination of reservation, polling and random access assignments.

11.3.2.3.2 *BROADCAST*

The HF DL ground station subsystem shall broadcast a squitter protocol data unit (SPDU) every 32 seconds on each of its operating frequencies.

Note.— Details on the TDMA frame and slot structures, pre-key segment, data structures, including the SPDU, are contained in the Manual on HF Data Link (Doc 9741).

11.3.2.4 RECEPTION OF DATA

11.3.2.4.1 *FREQUENCY SEARCH*

Each HF DL aircraft station shall automatically search the assigned frequencies until it detects an operating frequency.

11.3.2.4.2 RECEPTION OF PPDUS

The HF data link receiver shall provide the means to detect, synchronize, demodulate and decode PPDUs modulated according to the waveform defined in 11.3.1.5, subject to the following distortion:

- a) the 1 440 Hz audio carrier offset by plus or minus 70 Hz;
- b) discrete and/or diffuse multipath distortion with up to 5 ms multipath spread;
- c) multipath amplitude fading with up to 2 Hz two-sided RMS Doppler spread and Rayleigh statistics; and
- d) additive Gaussian and broadband impulsive noise with varying amplitude and random arrival times.

Note.— Reference CCIR Report 549-2.

11.3.2.4.3 DECODING OF PPDUS

Upon receipt of the preamble segment the receiver shall:

- a) detect the beginning of a burst of data;
- b) measure and correct the frequency offset between the transmitter and receiver due to Doppler shift and transmitter/receiver frequency offsets;
- c) determine the data rate and interleaver settings to use during data demodulation;
- d) achieve M-PSK symbol synchronization; and
- e) train the equalizer.

11.3.2.4.4 SYNCHRONIZATION

Each HF DL aircraft station subsystem shall synchronize its slot timing to that of its corresponding ground station with respect to the reception time of the last received SPDU.

11.3.2.4.5 SPECIFIED PACKET ERROR RATE PERFORMANCE

11.3.2.4.5.1 The number of HF DL media access protocol data units (MPDUs) received with one or more bit errors shall not exceed 5 per cent of the total number of MPDUs received, when using a 1.8 second interleaver and under the signal-in-space conditions shown in Table 11-3.

11.3.2.4.5.2 **Recommendation.**— *The number of HF DL MPDUs received with one or more bit errors should not exceed 5 per cent of the total number of MPDUs received, when using a 1.8 second interleaver under the conditions shown in Table 11-3a.*

11.3.3 Link layer

Note.— Details on link layer functions are contained in the Manual on HF Data Link (Doc 9741).

The link layer shall provide control functions for the physical layer, link management and data service protocols.

11.3.3.1 CONTROL FUNCTIONS

The link layer shall pass commands for frequency tuning, transmitter keying and transmitter/receiver switching to the physical layer.

11.3.3.2 LINK MANAGEMENT

The link layer shall manage TDMA slot assignments, log-on and log-off procedures, ground station and aircraft station TDMA synchronization, and other functions necessary, taking into account message priority, for the establishment and maintenance of communications.

11.3.3.3 DATA SERVICE PROTOCOLS

The link layer shall support a reliable link service (RLS) protocol and a direct link service (DLS) protocol.

11.3.3.3.1 RLS

The RLS protocol shall be used to exchange acknowledged user data packets between aircraft and ground peer link layers.

11.3.3.3.2 DLS

The DLS protocol shall be used to broadcast unsegmented uplink high frequency network protocol data units (HFNPDU) and other HFNPDU not requiring automatic retransmission by the link layer.

11.3.4 Subnetwork layer

Note.— Details on subnetwork layer protocols and services are contained in the Manual on HF Data Link (Doc 9741).

11.3.4.1 PACKET DATA

The HFDL subnetwork layer in the HFDL aircraft station subsystem and HFDL ground station subsystem shall provide connection-oriented packet data service by establishing subnetwork connections between subnetwork service users.

11.3.4.2 CONNECTIVITY NOTIFICATION SERVICE

The HFDL subnetwork layer in the HFDL aircraft station subsystem shall provide the additional connectivity notification service by sending connectivity notification event messages to the attached ATN router.

11.3.4.2.1 CONNECTIVITY NOTIFICATION EVENT MESSAGES

The connectivity notification service shall send connectivity notification event messages to the attached ATN router through the subnetwork access function.

11.3.4.3 HFDL SUBNETWORK LAYER FUNCTIONS

The HFDL subnetwork layer in both the HFDL aircraft station subsystem and HFDL ground station subsystem shall include the following three functions:

- a) HFDL subnetwork dependent (HFSND) function;
- b) subnetwork access function; and
- c) interworking function.

11.3.4.3.1 HFSND FUNCTION

The HFSND function shall perform the HFSND protocol between each pair of HFDL aircraft station subsystems and HFDL ground station subsystems by exchanging HFNPDU. It shall perform the HFSND protocol aircraft function in the HFDL aircraft station subsystem and the HFSND protocol ground function in the HFDL ground station subsystem.

11.3.4.3.2 SUBNETWORK ACCESS FUNCTION

The subnetwork access function shall perform the ISO 8208 protocol between the HFDL aircraft station subsystem or HFDL ground station subsystem and the attached routers by exchanging ISO 8208 packets. It shall perform the ISO 8208 DCE function in the HFDL aircraft station subsystem and the HFDL ground station subsystem.

11.3.4.3.3 INTERWORKING FUNCTION

The interworking function shall provide the necessary harmonization functions between the HFSND, the subnetwork access and the connectivity notification functions.

11.4 GROUND MANAGEMENT SUBSYSTEM

Note.— Details on the ground management subsystem functions and interfaces are contained in the Manual on HF Data Link (Doc 9741).

11.4.1 Management functions

The ground management subsystem shall perform the functions necessary to establish and maintain communications channels between the HFDL ground and aircraft station subsystems.

11.4.2 Management/control information exchange

The ground management subsystem shall interface with the ground station subsystem in order to exchange control information required for frequency management, system table management, log status management, channel management, and quality of service (QOS) data collection.

TABLES FOR CHAPTER 11

Table 11-1. Transfer delays

	<i>Direction</i>	<i>Priority</i>	<i>Delay</i>
<i>Transit delay</i>	To-aircraft	7 through 14	45 s
	From-aircraft	7 through 14	60 s
<i>Transfer delay (95 percentile)</i>	To-aircraft	11 through 14	90 s
		7 through 10	120 s
	From-aircraft	11 through 14	150 s
		7 through 10	250 s

Table 11-2. Value of M and information data rate

<i>M</i>	<i>Information data rate (bits per second)</i>
2	300 or 600
4	1 200
8	1 800

Note.— When *M* equals the value 2, the data rate may be 300 or 600 bits per second as determined by the channel coding rate. The value of *M* may change from one data transmission to another depending on the data rate selected. The channel coding rate is described in the Manual on HF Data Link (Doc 9741).

Table 11-3. HF signal-in-space conditions

<i>Data rate (bits per second)</i>	<i>Number of channel paths</i>	<i>Multipath spread (milliseconds)</i>	<i>Fading bandwidth (Hz) per CCIR Report 5492</i>	<i>Frequency offset (Hz)</i>	<i>Signal to noise ratio (dB) in a 3 kHz bandwidth</i>	<i>MPDU size (octets)</i>
1 200	1 fixed	—	—	40	4	256
1 800	2 fading	2	1	40	16	400
1 200	2 fading	2	1	40	11.5	256
600	2 fading	2	1	40	8	128
300	2 fading	2	1	40	5	64

Table 11-3a. HF signal-in-space conditions

<i>Data rate (bits per second)</i>	<i>Number of channel paths</i>	<i>Multipath spread (milliseconds)</i>	<i>Fading bandwidth (Hz) per CCIR Report 5492</i>	<i>Frequency offset (Hz)</i>	<i>Signal to noise ratio (dB) in a 3 kHz bandwidth</i>	<i>MPDU size (octets)</i>
1 200	2 fading	4	1	40	13	256
1 200	2 fading	2	2	40	11.5	256

FIGURE FOR CHAPTER 11

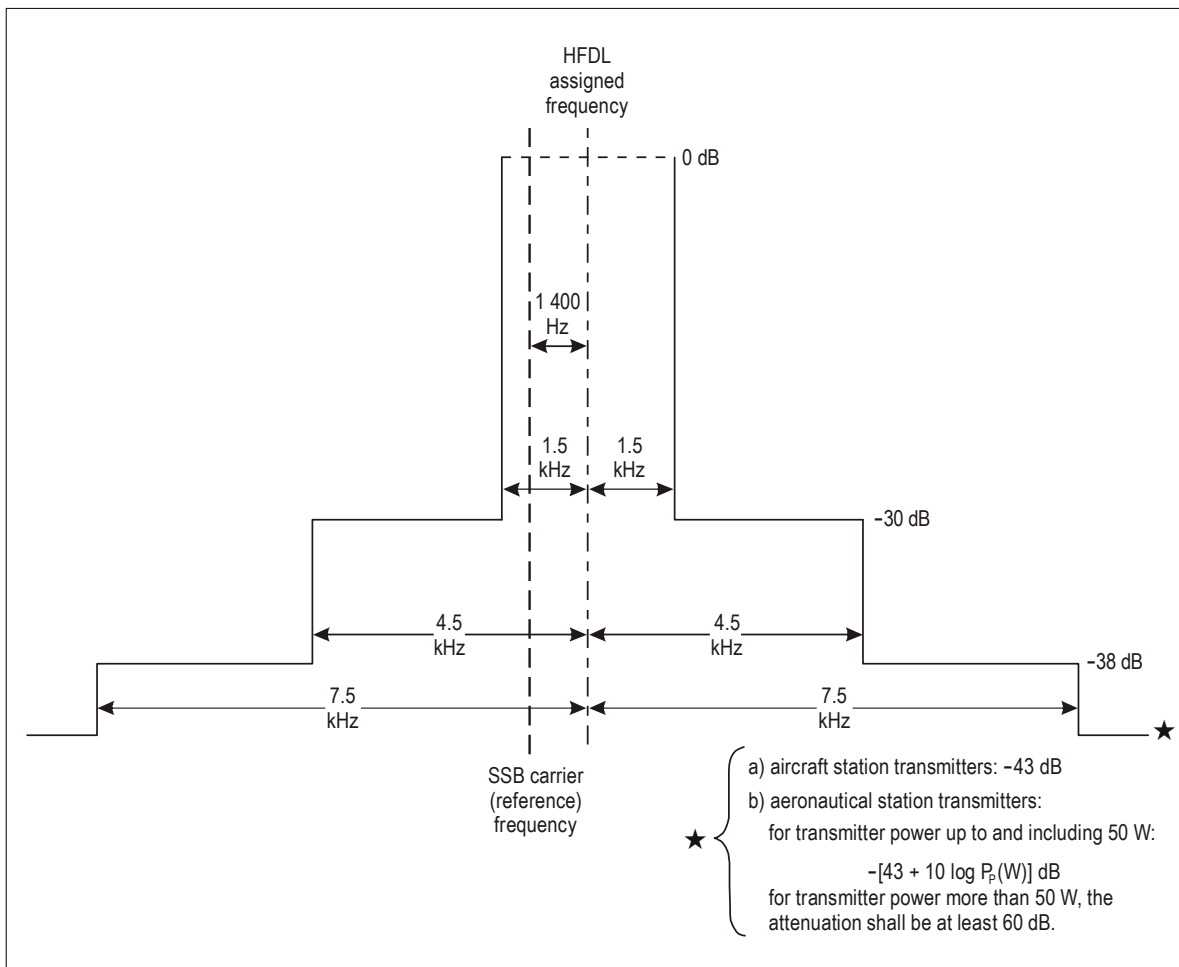

Figure 11-1. Required spectrum limits (in terms of peak power) for HF DL aircraft and ground station transmitters

CHAPTER 12. UNIVERSAL ACCESS TRANSCEIVER (UAT)

12.1 DEFINITIONS AND OVERALL SYSTEM CHARACTERISTICS

12.1.1 Definitions

High performance receiver. A UAT receiver with enhanced selectivity to further improve the rejection of adjacent frequency DME interference (see 12.3.2.2 for further details).

Optimum sampling point. The optimum sampling point of a received UAT bit stream is at the nominal centre of each bit period, when the frequency offset is either plus or minus 312.5 kHz.

Power measurement point (PMP). A cable connects the antenna to the UAT equipment. The PMP is the end of that cable that attaches to the antenna. All power measurements are considered as being made at the PMP unless otherwise specified. The cable connecting the UAT equipment to the antenna is assumed to have 3 dB of loss.

Pseudorandom message data block. Several UAT requirements state that performance will be tested using pseudorandom message data blocks. Pseudorandom message data blocks should have statistical properties that are nearly indistinguishable from those of a true random selection of bits. For instance, each bit should have (nearly) equal probability of being a ONE or a ZERO, independent of its neighbouring bits. There should be a large number of such pseudorandom message data blocks for each message type (Basic ADS-B, Long ADS-B or Ground Uplink) to provide sufficient independent data for statistical performance measurements. See Section 2.3 of Part I of the *Manual on the Universal Access Transceiver (UAT)* (Doc 9861) for an example of how to provide suitable pseudorandom message data blocks.

Service volume. A part of the facility coverage where the facility provides a particular service in accordance with relevant SARPs and within which the facility is afforded frequency protection.

Standard UAT receiver. A general purpose UAT receiver satisfying the minimum rejection requirements of interference from adjacent frequency distance measuring equipment (DME) (see 12.3.2.2 for further details).

Successful message reception (SMR). The function within the UAT receiver for declaring a received message as valid for passing to an application that uses received UAT messages. See Section 4 of Part I of the *Manual on the Universal Access Transceiver (UAT)* (Doc 9861) for a detailed description of the procedure to be used by the UAT receiver for declaring successful message reception.

UAT ADS-B message. A message broadcasted once per second by each aircraft to convey state vector and other information. UAT ADS-B messages can be in one of two forms depending on the amount of information to be transmitted in a given second: the *Basic UAT ADS-B Message* or the *Long UAT ADS-B Message* (see 12.4.4.1 for definition of each). UAT ground stations can support traffic information service-broadcast (TIS-B) through transmission of individual ADS-B messages in the ADS-B segment of the UAT frame.

UAT ground uplink message. A message broadcasted by ground stations, within the ground segment of the UAT frame, to convey flight information such as text and graphical weather data, advisories, and other aeronautical information, to aircraft that are in the service volume of the ground station (see 12.4.4.2 for further details).

Universal access transceiver (UAT). A broadcast data link operating on 978 MHz, with a modulation rate of 1.041667 Mbps.

12.1.2 UAT overall system characteristics of aircraft and ground stations

Note.— Details on technical requirements related to the implementation of UAT SARPs are contained in Part I of the Manual on the Universal Access Transceiver (UAT) (Doc 9861). Part II of the Manual on the Universal Access Transceiver (UAT) (Doc 9861) (in preparation) will provide additional guidance material.

12.1.2.1 TRANSMISSION FREQUENCY

The transmission frequency shall be 978 MHz.

12.1.2.2 FREQUENCY STABILITY

The radio frequency of the UAT equipment shall not vary more than ± 0.002 per cent (20 ppm) from the assigned frequency.

12.1.2.3 TRANSMIT POWER

12.1.2.3.1 TRANSMIT POWER LEVELS

UAT equipment shall operate at one of the power levels shown in Table 12-1*.

12.1.2.3.2 MAXIMUM POWER

The maximum equivalent isotropically radiated power (EIRP) for a UAT aircraft or ground station shall not exceed +58 dBm.

Note.— For example, the maximum EIRP listed above could result from the maximum allowable aircraft transmitter power shown in Table 12-1 with a maximum antenna gain of 4 dBi.

12.1.2.3.3 TRANSMIT MASK

The spectrum of a UAT ADS-B message transmission modulated with pseudorandom message data blocks (MDB) shall fall within the limits specified in Table 12-2 when measured in a 100 kHz bandwidth.

Note.— Figure 12-1* is a graphical representation of Table 12-2.

12.1.2.4 SPURIOUS EMISSIONS

Spurious emissions shall be kept at the lowest value which the state of the technique and the nature of the service permit.

Note.— Appendix 3 of the ITU Radio Regulations requires that transmitting stations shall conform to the maximum permitted power levels for spurious emissions or for unwanted emissions in the spurious domain.

* All tables and figures are located at the end of the chapter.

12.1.2.5 POLARIZATION

The design polarization of emissions shall be vertical.

12.1.2.6 TIME/AMPLITUDE PROFILE OF UAT MESSAGE TRANSMISSION

The time/amplitude profile of a UAT message transmission shall meet the following requirements, in which the *reference time* is defined as the beginning of the first bit of the synchronization sequence (see 12.4.4.1.1, 12.4.4.2.1) appearing at the output port of the equipment.

Notes.—

1. All power requirements for subparagraphs “a” through “f” below apply to the PMP. For installations that support transmitter diversity, the RF power output on the non-selected antenna port should be at least 20 dB below the level on the selected port.

2. All power requirements for subparagraphs “a” and “f” assume a 300 kHz measurement bandwidth. All power requirements for subparagraphs “b”, “c”, “d” and “e” assume a 2 MHz measurement bandwidth.

3. The beginning of a bit is 1/2 bit period prior to the optimum sample point.

4. These requirements are depicted graphically in Figure 12-2.

a) Prior to 8 bit periods before the reference time, the RF output power at the PMP shall not exceed –80 dBm.

Note.— This unwanted radiated power restriction is necessary to ensure that the UAT transmitting subsystem does not prevent closely located UAT receiving equipment on the same aircraft from meeting its requirements. It assumes that the isolation between transmitter and receiver equipment at the PMP exceeds 20 dB.

b) Between 8 and 6 bit periods prior to the reference time, the RF output power at the PMP shall remain at least 20 dB below the minimum power requirement for the UAT equipment class.

Note.— Guidance on definition of UAT equipment classes will be provided in Part II of the Manual on the Universal Access Transceiver (UAT) (Doc 9861) (in preparation).

c) During the Active state, defined as beginning at the reference time and continuing for the duration of the message, the RF output power at the PMP shall be greater than or equal to the minimum power requirement for the UAT equipment class.

d) The RF output power at the PMP shall not exceed the maximum power for the UAT equipment class at any time during the Active state.

e) Within 6 bit periods after the end of the Active state, the RF output power at the PMP shall be at a level at least 20 dB below the minimum power requirement for the UAT equipment class.

f) Within 8 bit periods after the end of the Active state, the RF output power at the PMP shall fall to a level not to exceed –80 dBm.

Note.— This unwanted radiated power restriction is necessary to ensure that the transmitting subsystem does not prevent closely located UAT receiving equipment on the same aircraft from meeting its requirements. It assumes that the isolation between transmitter and receiver equipment at the PMP exceeds 20 dB.

12.1.3 Mandatory carriage requirements

Requirements for mandatory carriage of UAT equipment shall be made on the basis of regional air navigation agreements which specify the airspace of operation and the implementation timescales for the carriage of equipment, including the appropriate lead time.

Note.— No changes will be required to aircraft systems or ground systems operating solely in regions not using UAT.

12.2 SYSTEM CHARACTERISTICS OF THE GROUND INSTALLATION

12.2.1 Ground station transmitting function

12.2.1.1 GROUND STATION TRANSMITTER POWER

12.2.1.1.1 **Recommendation.**— *The effective radiated power should be such as to provide a field strength of at least 280 microvolts per metre (minus 97 dBW/m²) within the service volume of the facility on the basis of free-space propagation.*

Note.— *This is determined on the basis of delivering a -91 dBm (corresponds to 200 microvolts per metre) signal level at the PMP (assuming an omnidirectional antenna). The 280 μ V/m recommendation corresponds to the delivery of a -88 dBm signal level at the PMP of the receiving equipment. The 3 dB difference between -88 dBm and -91 dBm provides margin for excess path loss over free-space propagation.*

12.2.2 Ground station receiving function

Note.— *An example ground station receiver is discussed in Section 2.5 of Part II of the Manual on the Universal Access Transceiver (UAT) (Doc 9861), with UAT air-to-ground performance estimates consistent with use of that receiver provided in Appendix B of that manual.*

12.3 SYSTEM CHARACTERISTICS OF THE AIRCRAFT INSTALLATION

12.3.1 Aircraft transmitting function

12.3.1.1 AIRCRAFT TRANSMITTER POWER

The effective radiated power shall be such as to provide a field strength of at least 225 microvolts per metre (minus 99 dBW/m²) on the basis of free-space propagation, at ranges and altitudes appropriate to the operational conditions pertaining to the areas over which the aircraft is operated. Transmitter power shall not exceed 54 dBm at the PMP.

Note 1.— *The above field strength is determined on the basis of delivering a -93 dBm (corresponds to 160 microvolts per metre) signal level at the PMP (assuming an omnidirectional antenna). The 3 dB difference between 225 μ V/m and 160 μ V/m provides margin for excess path loss over free-space propagation when receiving a long UAT ADS-B message. A 4 dB margin is provided when receiving a basic UAT ADS-B message.*

Note 2.—Various aircraft operations may have different air-air range requirements depending on the intended ADS-B function of the UAT equipment. Therefore different installations may operate at different power levels (see 12.1.2.3.1).

12.3.2 Receiving function

12.3.2.1 RECEIVER SENSITIVITY

12.3.2.1.1 LONG UAT ADS-B MESSAGE AS DESIRED SIGNAL

A desired signal level of -93 dBm applied at the PMP shall produce a rate of successful message reception (SMR) of 90 per cent or better under the following conditions:

- a) When the desired signal is of nominal modulation (i.e. FM deviation is 625 kHz) and at the maximum signal frequency offsets, and subject to relative Doppler shift at ± 1 200 knots;
- b) When the desired signal is of maximum modulation distortion allowed in 12.4.3, at the nominal transmission frequency ± 1 parts per million (ppm), and subject to relative Doppler shift at ± 1 200 knots.

Note. — The receiver criteria for successful message reception of UAT ADS-B messages are provided in Section 4 of Part I of the Manual on the Universal Access Transceiver (UAT) (Doc 9861).

12.3.2.1.2 BASIC UAT ADS-B MESSAGE AS DESIRED SIGNAL

A desired signal level of -94 dBm applied at the PMP shall produce a rate of SMR of 90 per cent or better under the following conditions:

- a) When the desired signal is of nominal modulation (i.e. FM deviation is 625 kHz) and at the maximum signal frequency offsets, and subject to relative Doppler shift at ± 1 200 knots;
- b) When the desired signal is of maximum modulation distortion allowed in 12.4.3, at the nominal transmission frequency ± 1 ppm, and subject to relative Doppler shift at ± 1 200 knots.

Note.— The receiver criteria for successful message reception of UAT ADS-B messages are provided in Section 4 of Part I of the Manual on the Universal Access Transceiver (UAT) (Doc 9861).

12.3.2.1.3 UAT GROUND UPLINK MESSAGE AS DESIRED SIGNAL

A desired signal level of -91 dBm applied at the PMP shall produce a rate of an SMR of 90 per cent or better under the following conditions:

- a) When the desired signal is of nominal modulation (i.e. FM deviation is 625 kHz) and at the maximum signal frequency offsets, and subject to relative Doppler shift at ± 850 knots;
- b) When the desired signal is of maximum modulation distortion allowed in 12.4.3, at the nominal transmission frequency ± 1 ppm, and subject to relative Doppler shift at ± 850 knots.

Notes.—

1. *The receiver criteria for successful message reception of UAT ground uplink messages are provided in Section 4 of Part I of the Manual on the Universal Access Transceiver (UAT) (Doc 9861) (in preparation).*

2. This requirement ensures the bit rate accuracy supporting demodulation in the UAT equipment is adequate to properly receive the longer UAT ground uplink message.

12.3.2.2 RECEIVER SELECTIVITY

Notes.—

1. The undesired signal used is an unmodulated carrier applied at the frequency offset.
2. This requirement establishes the receiver's rejection of the off-channel energy.
3. It is assumed that ratios in between the specified offsets will fall near the interpolated value.
4. The desired signal used is a UAT ADS-B long message at -90 dBm at the PMP, to be received with a 90 per cent successful message reception rate.
5. The tolerable co-channel continuous wave interference power level for aircraft UAT receivers is assumed to be -101 dBm or less at the PMP.
6. See Section 2.4.2 of Part II of the Manual on the Universal Access Transceiver (UAT) (Doc 9861) for a discussion of when a high-performance receiver is desirable.
 - a) Standard UAT receivers shall meet the selectivity characteristics given in Table 12-3.
 - b) High-performance receivers shall meet the more stringent selectivity characteristics given in Table 12-4.

Note.— See Section 2.4.2 of Part II of the Manual on the Universal Access Transceiver (UAT) (Doc 9861) for guidance material on the implementation of high-performance receivers.

12.3.2.3 RECEIVER DESIRED SIGNAL DYNAMIC RANGE

The receiver shall achieve a successful message reception rate for long ADS-B messages of 99 per cent or better when the desired signal level is between -90 dBm and -10 dBm at the PMP in the absence of any interfering signals.

Note.— The value of -10 dBm represents 120-foot separation from an aircraft transmitter transmitting at maximum allowed power.

12.3.2.4 RECEIVER TOLERANCE TO PULSED INTERFERENCE

Note.— All power level requirements in this section are referenced to the PMP.

- a) For Standard and High-Performance receivers the following requirements shall apply:
 - 1) The receiver shall be capable of achieving 99 per cent SMR of long UAT ADS-B messages when the desired signal level is between -90 dBm and -10 dBm when subjected to DME interference under the following conditions: DME pulse pairs at a nominal rate of 3 600 pulse pairs per second at either 12 or 30 microseconds pulse spacing at a level of -36 dBm for any 1 MHz DME channel frequency between 980 MHz and 1 213 MHz inclusive.

- 2) Following a 21 microsecond pulse at a level of ZERO (0) dBm and at a frequency of 1 090 MHz, the receiver shall return to within 3 dB of the specified sensitivity level (see 12.3.2.1) within 12 microseconds.
- b) For the standard UAT receiver the following additional requirements shall apply:
- 1) The receiver shall be capable of achieving 90 per cent SMR of long UAT ADS-B messages when the desired signal level is between -87 dBm and -10 dBm when subjected to DME interference under the following conditions: DME pulse pairs at a nominal rate of 3 600 pulse pairs per second at a 12 microseconds pulse spacing at a level of -56 dBm and a frequency of 979 MHz.
 - 2) The receiver shall be capable of achieving 90 per cent SMR of long UAT ADS-B messages when the desired signal level is between -87 dBm and -10 dBm when subjected to DME interference under the following conditions: DME pulse pairs at a nominal rate of 3 600 pulse pairs per second at a 12 microseconds pulse spacing at a level of -70 dBm and a frequency of 978 MHz.
- c) For the high-performance receiver the following additional requirements shall apply:
- 1) The receiver shall be capable of achieving 90 per cent SMR of long UAT ADS-B messages when the desired signal level is between -87 dBm and -10 dBm when subjected to DME interference under the following conditions: DME pulse pairs at a nominal rate of 3 600 pulse pairs per second at a 12 microseconds pulse spacing at a level of -43 dBm and a frequency of 979 MHz.
 - 2) The receiver shall be capable of achieving 90 per cent SMR of long UAT ADS-B messages when the desired signal level is between -87 dBm and -10 dBm when subjected to DME interference under the following conditions: DME pulse pairs at a nominal rate of 3 600 pulse pairs per second at a 12 microseconds pulse spacing at a level of -79 dBm and a frequency of 978 MHz.

12.4 PHYSICAL LAYER CHARACTERISTICS

12.4.1 Modulation rate

The modulation rate shall be 1.041 667 Mbps with a tolerance for aircraft transmitters of ± 20 ppm and a tolerance for ground transmitters of ± 2 ppm.

Note.— The tolerance on the modulation rate is consistent with the requirement on modulation distortion (see 12.4.3).

12.4.2 Modulation type

- a) Data shall be modulated onto the carrier using binary continuous phase frequency shift keying. The modulation index, h , shall be no less than 0.6;
- b) A binary ONE (1) shall be indicated by a shift up in frequency from the nominal carrier frequency and a binary ZERO (0) by a shift down from the nominal carrier frequency.

Notes.—

1. Filtering of the transmitted signal (at base band and/or after frequency modulation) will be required to meet the spectral containment requirement of 12.1.2.3.3. This filtering may cause the deviation to exceed these values at points other than the optimum sampling points.

2. Because of the filtering of the transmitted signal, the received frequency offset varies continuously between the nominal values of ± 312.5 kHz (and beyond), and the optimal sampling point may not be easily identified. This point can be defined in terms of the so-called “eye diagram” of the received signal. The ideal eye diagram is a superposition of samples of the (undistorted) post detection waveform shifted by multiples of the bit period (0.96 microseconds). The optimum sampling point is the point during the bit period at which the opening of the eye diagram (i.e. the minimum separation between positive and negative frequency offsets at very high signal-to-noise ratios) is maximized. An example “eye diagram” can be seen in Figure 12-3. The timing of the points where the lines converge defines the “optimum sampling point”. Figure 12-4 shows an eye pattern that has been partially closed by modulation distortion.

12.4.3 Modulation distortion

- a) For aircraft transmitters, the minimum vertical opening of the eye diagram of the transmitted signal (measured at the optimum sampling points) shall be no less than 560 kHz when measured over an entire long UAT ADS-B message containing pseudorandom message data blocks.
- b) For ground transmitters, the minimum vertical opening of the eye diagram of the transmitted signal (measured at the optimum sampling points) shall be no less than 560 kHz when measured over an entire UAT ground uplink message containing pseudorandom message data blocks.
- c) For aircraft transmitters, the minimum horizontal opening of the eye diagram of the transmitted signal (measured at 978 MHz) shall be no less than 0.624 microseconds (0.65 symbol periods) when measured over an entire long UAT ADS-B message containing pseudorandom message data blocks.
- d) For ground transmitters, the minimum horizontal opening of the eye diagram of the transmitted signal (measured at 978 MHz) shall be no less than 0.624 microseconds (0.65 symbol periods) when measured over an entire UAT ground uplink message containing pseudorandom message data blocks.

Notes.—

1. Section 12.4.4 defines the UAT ADS-B message types.
2. The ideal eye diagram is a superposition of samples of the (undistorted) post detection waveform shifted by multiples of the bit period (0.96 microseconds).

12.4.4 Broadcast message characteristics

The UAT system shall support two different message types: the UAT ADS-B message and the UAT ground uplink message.

12.4.4.1 UAT ADS-B MESSAGE

The Active portion (see 12.1.2.6) of a UAT ADS-B message shall contain the following elements, in the following order:

- Bit synchronization
- Message data block
- FEC parity.

12.4.4.1.1 BIT SYNCHRONIZATION

The first element of the Active portion of the UAT ADS-B message shall be a 36-bit synchronization sequence. For the UAT ADS-B messages the sequence shall be:

$$111010101100110111011010010011100010$$

with the left-most bit transmitted first.

12.4.4.1.2 THE MESSAGE DATA BLOCK

The second element of the Active portion of the UAT ADS-B message shall be the message data block. There shall be two lengths of UAT ADS-B message data blocks supported. The basic UAT ADS-B message shall have a 144-bit message data block and the long UAT ADS-B message shall have a 272-bit message data block.

Note.— The format, encoding and transmission order of the message data block element is provided in Section 2.1 of Part I of the Manual on the Universal Access Transceiver (UAT) (Doc 9861).

12.4.4.1.3 FEC PARITY

The third and final element of the Active portion of the UAT ADS-B message shall be the FEC parity.

12.4.4.1.3.1 Code type

The FEC parity generation shall be based on a systematic Reed-Solomon (RS) 256-ary code with 8-bit code word symbols. FEC parity generation shall be per the following code:

- a) **Basic UAT ADS-B message:** Parity shall be a RS (30, 18) code.

Note.— This results in 12 bytes (code symbols) of parity capable of correcting up to 6 symbol errors per block.

- b) **Long UAT ADS-B message:** Parity shall be a RS (48, 34) code.

Note.— This results in 14 bytes (code symbols) of parity capable of correcting up to 7 symbol errors per block.

For either message length the primitive polynomial of the code shall be as follows:

$$p(x) = x^8 + x^7 + x^2 + x + 1$$

The generator polynomial shall be as follows:

$$\prod_{i=120}^P (x - \alpha^i)$$

where:

P = 131 for RS (30, 18) code,

P = 133 for RS (48, 34) code, and

α is a primitive element of a Galois field of size 256 (i.e. GF(256)).

12.4.4.1.3.2 *Transmission order of FEC parity*

FEC parity bytes shall be ordered most significant to least significant in terms of the polynomial coefficients they represent. The ordering of bits within each byte shall be most significant to least significant. FEC parity bytes shall follow the message data block.

12.4.4.2 UAT GROUND UPLINK MESSAGE

The Active portion of a UAT ground uplink message shall contain the following elements, in the following order:

- Bit synchronization
- Interleaved message data block and FEC parity.

12.4.4.2.1 *BIT SYNCHRONIZATION*

The first element of the Active portion of the UAT ground uplink message shall be a 36-bit synchronization sequence. For the UAT ground uplink message the sequence shall be:

000101010011001000100101101100011101

with the left-most bit transmitted first.

12.4.4.2.2 *INTERLEAVED MESSAGE DATA BLOCK AND FEC PARITY*12.4.4.2.2.1 *Message data block (before interleaving and after de-interleaving)*

The UAT ground uplink message shall have 3 456 bits of message data block. These bits are divided into 6 groups of 576 bits. FEC is applied to each group as described in 12.4.4.2.2.2.

Note.— Further details on the format, encoding and transmission order of the UAT ground uplink message data block are provided in Section 2.2 of Part I of the Manual on the Universal Access Transceiver (UAT) (Doc 9861).

12.4.4.2.2.2 *FEC parity (before interleaving and after de-interleaving)*12.4.4.2.2.2.1 *Code type*

The FEC parity generation shall be based on a systematic RS 256-ary code with 8-bit code word symbols. FEC parity generation for each of the six blocks shall be a RS (92,72) code.

Notes.—

1. Section 12.4.4.2.2.3 provides details on the interleaving procedure.
2. This results in 20 bytes (symbols) of parity capable of correcting up to 10 symbol errors per block. The additional use of interleaving for the UAT ground uplink message allows additional robustness against burst errors.

The primitive polynomial of the code is as follows:

$$p(x) = x^8 + x^7 + x^2 + x + 1$$

The generator polynomial is as follows:

$$\prod_{i=120}^P (x - \alpha^i)$$

where:

$P = 139$, and

α is a primitive element of a Galois field of size 256 (i.e. GF(256)).

12.4.4.2.2.2.2 *Transmission order of FEC parity*

FEC parity bytes are ordered most significant to least significant in terms of the polynomial coefficients they represent. The ordering of bits within each byte shall be most significant to least significant. FEC parity bytes shall follow the message data block.

12.4.4.2.2.3 *Interleaving procedure*

UAT ground uplink messages shall be interleaved and transmitted by the ground station, as listed below:

- a) **Interleaving procedure:** The interleaved message data block and FEC parity consists of 6 interleaved Reed-Solomon blocks. The interleaver is represented by a 6×92 matrix, where each entry is a RS 8-bit symbol. Each row comprises a single RS (92,72) block as shown in Table 12-5. In this table, block numbers prior to interleaving are represented as “A” through “F”. The information is ordered for transmission column by column, starting at the upper left corner of the matrix.
- b) **Transmission order:** The bytes are then transmitted in the following order:

1,73,145,217,289,361,2,74,146,218,290,362,3,.. .,C/20,D/20,E/20,F/20.

Note.— On reception these bytes need to be de-interleaved so that the RS blocks can be reassembled prior to error correction decoding.

12.5 GUIDANCE MATERIAL

Notes.—

1. *The Manual on the Universal Access Transceiver (UAT) (Doc 9861), Part I, provides detailed technical specifications on UAT, including ADS-B message data blocks and formats, procedures for operation of UAT transmitting subsystems, and avionics interface requirements with other aircraft systems.*
2. *The Manual on the Universal Access Transceiver (UAT) (Doc 9861), Part II, provides information on UAT system operation, description of a range of example avionics equipment classes and their applications, guidance on UAT aircraft and ground station installation aspects, and detailed information on UAT system performance simulation.*

TABLES FOR CHAPTER 12

Table 12-1. Transmitter power levels

<i>Transmitter type</i>	<i>Minimum power at PMP</i>	<i>Maximum power at PMP</i>	<i>Intended minimum air-to-air ranges</i>
Aircraft (Low)	7 watts (+38.5 dBm)	18 watts (+42.5 dBm)	20 NM
Aircraft (Medium)	16 watts (+42 dBm)	40 watts (+46 dBm)	40 NM
Aircraft (High)	100 watts (+50 dBm)	250 watts (+54 dBm)	120 NM
Ground Station	Specified by the service provider to meet local requirements within the constraint of 12.1.2.3.2.		

Notes.—

1. The three levels listed for the avionics are available to support applications with varying range requirements. See the discussion of UAT aircraft Equipage Classes in Section 2.4.2 of Part II of the Manual on the Universal Access Transceiver (UAT) (Doc 9861) (in preparation).
2. The intended minimum air-to-air ranges are for high-density air traffic environments. Larger air-to-air ranges will be achieved in low-density air traffic environments.

Table 12-2. UAT transmit spectrum

<i>Frequency offset from centre</i>	<i>Required attenuation from maximum power level (dB as measured at the PMP)</i>
All frequencies in the range 0 – 0.5 MHz	0
All frequencies in the range 0.5 – 1.0 MHz	Based on linear* interpolation between these points
1.0 MHz	18
All frequencies in the range 1.0 – 2.25 MHz	Based on linear* interpolation between these points
2.25 MHz	50
All frequencies in the range 2.25 – 3.25 MHz	Based on linear* interpolation between these points
3.25 MHz	60

* based on attenuation in dB and a linear frequency scale

Table 12-3. Standard UAT receiver rejection ratios

<i>Frequency offset from centre</i>	<i>Minimum rejection ratio (Undesired/desired level in dB)</i>
-1.0 MHz	10
+1.0 MHz	15
(±) 2.0 MHz	50
(±) 10.0 MHz	60

Note.— It is assumed that ratios in between the specified offsets will fall near the interpolated value.

Table 12-4. High-performance receiver rejection ratios

<i>Frequency offset from centre</i>	<i>Minimum rejection ratio (Undesired/desired level in dB)</i>
-1.0 MHz	30
+1.0 MHz	40
(±) 2.0 MHz	50
(±) 10.0 MHz	60

Table 12-5. Ground uplink interleaver matrix

<i>RS Block</i>	<i>MDB Byte #</i>						<i>FEC Parity (Block/Byte #)</i>			
	1	2	3	...	71	72	A/1	...	A/19	A/20
A	1	2	3	...	71	72	A/1	...	A/19	A/20
B	73	74	75	...	143	144	B/1	...	B/19	B/20
C	145	146	147	...	215	216	C/1	...	C/19	C/20
D	217	218	219	...	287	288	D/1	...	D/19	D/20
E	289	290	291	...	359	360	E/1	...	E/19	E/20
F	361	362	363	...	431	432	F/1	...	F/19	F/20

Note.— In Table 12-5, message data block Byte #1 through #72 are the 72 bytes (8 bits each) of message data block information carried in the first RS (92,72) block. FEC parity A/1 through A/20 are the 20 bytes of FEC parity associated with that block (A).

FIGURES FOR CHAPTER 12

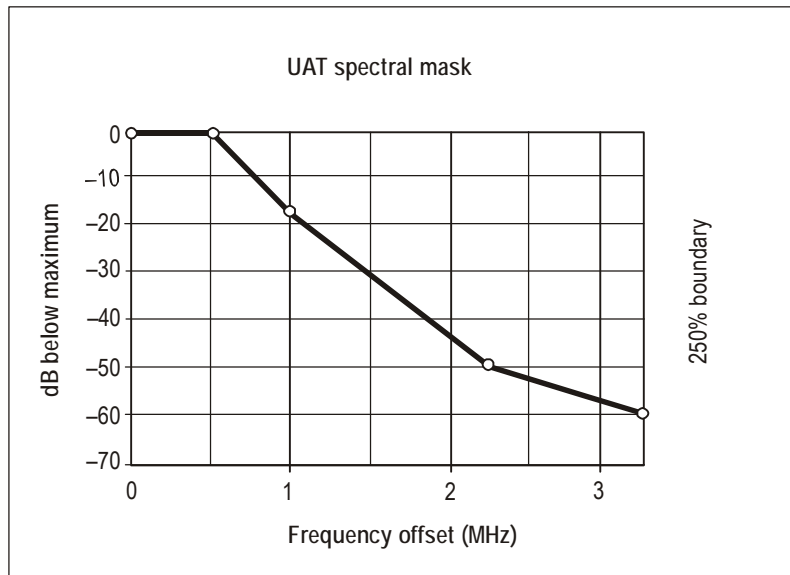

Notes.—

1. 99 per cent of the power of the UAT spectrum is contained in 1.3 MHz (± 0.65 MHz). This is roughly equivalent to the 20 dB bandwidth.
2. Spurious emissions requirements begin at ± 250 per cent of the 1.3 MHz value, therefore the transmit mask requirement extends to ± 3.25 MHz.

Figure 12-1. UAT transmit spectrum

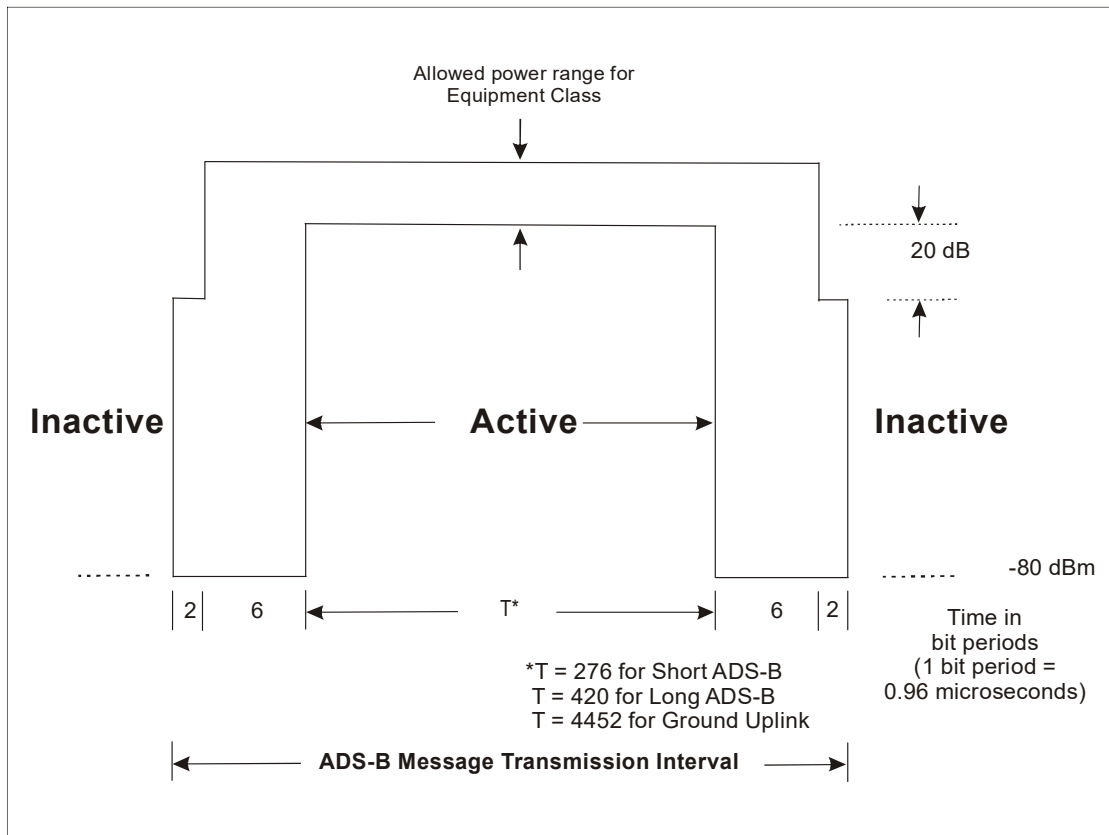

Figure 12-2. Time/amplitude profile of UAT message transmission

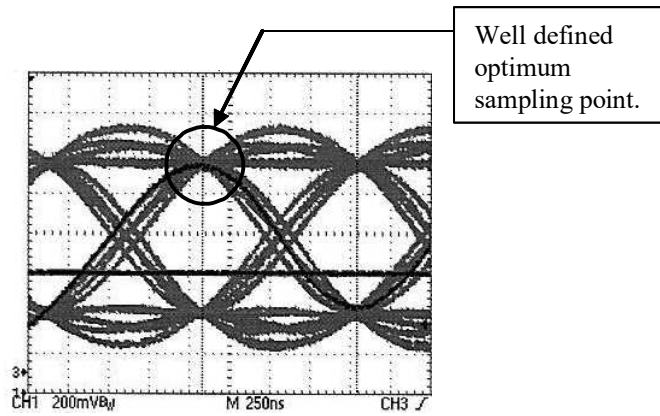

Figure 12-3. Ideal eye diagram

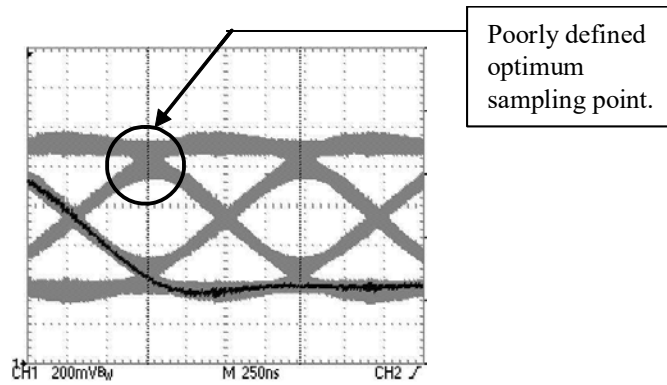

Figure 12-4. Distorted eye diagram

INTERNATIONAL STANDARDS AND RECOMMENDED PRACTICES

PART II — VOICE COMMUNICATION SYSTEMS

CHAPTER 1. DEFINITIONS

Note.— Material on secondary power supply and guidance material concerning reliability and availability for communication systems is contained in Annex 10, Volume I, 2.9 and Volume I, Attachment F, respectively.

CHAPTER 2. AERONAUTICAL MOBILE SERVICE

2.1 AIR-GROUND VHF COMMUNICATION SYSTEM CHARACTERISTICS

Note.— In the following text the channel spacing for 8.33 kHz channel assignments is defined as 25 kHz divided by 3 which is 8.3333 ... kHz.

2.1.1 The characteristics of the air-ground VHF communication system used in the International Aeronautical Mobile Service shall be in conformity with the following specifications:

2.1.1.1 Radiotelephone emissions shall be double sideband (DSB) amplitude modulated (AM) carriers. The designation of emission is A3E, as specified in the ITU Radio Regulations.

2.1.1.2 Spurious emissions shall be kept at the lowest value which the state of technique and the nature of the service permit.

Note.— Appendix S3 to the ITU Radio Regulations specifies the levels of spurious emissions to which transmitters must conform.

2.1.1.3 The radio frequencies used shall be selected from the radio frequencies in the band 117.975 – 137 MHz. The separation between assignable frequencies (channel spacing) and frequency tolerances applicable to elements of the system shall be as specified in Volume V.

Note.— The band 117.975 – 132 MHz was allocated to the Aeronautical Mobile (R) Service in the ITU Radio Regulations (1947). By subsequent revisions at ITU World Administrative Radio Conferences the bands 132 – 136 MHz and 136 – 137 MHz were added under conditions which differ for ITU Regions, or for specified countries or combinations of countries (see RRs S5.203, S5.203A and S5.203B for additional allocations in the band 136 – 137 MHz, and S5.201 for the band 132 – 136 MHz).

2.1.1.4 The design polarization of emissions shall be vertical.

2.2 SYSTEM CHARACTERISTICS OF THE GROUND INSTALLATION

2.2.1 Transmitting function

2.2.1.1 *Frequency stability.* The radio frequency of operation shall not vary more than plus or minus 0.005 per cent from the assigned frequency. Where 25 kHz channel spacing is introduced in accordance with Volume V, the radio frequency of operation shall not vary more than plus or minus 0.002 per cent from the assigned frequency. Where 8.33 kHz channel spacing is introduced in accordance with Volume V, the radio frequency of operation shall not vary more than plus or minus 0.0001 per cent from the assigned frequency.

Note.— The above frequency stability requirements will not be sufficient for offset carrier systems using 25 kHz channel spacing or higher.

2.2.1.1.1 Offset carrier systems in 8.33 kHz, 25 kHz, 50 kHz and 100 kHz channel spaced environments. The stability of individual carriers of an offset carrier system shall be such as to prevent first-order heterodyne frequencies of less than 4 kHz and, additionally, the maximum frequency excursion of the outer carrier frequencies from the assigned carrier frequency shall not exceed 8 kHz. Offset carrier systems for 8.33 kHz channel spacing shall be limited to two-carrier systems using a carrier offset of plus and minus 2.5 kHz.

Note.— *Examples of the required stability of the individual carriers of offset carrier systems may be found at the Attachment to Part II.*

2.2.1.2 POWER

Recommendation.— *On a high percentage of occasions, the effective radiated power should be such as to provide a field strength of a least 75 microvolts per metre (minus 109 dBW/m²) within the defined operational coverage of the facility, on the basis of free-space propagation.*

2.2.1.3 *Modulation.* A peak modulation factor of at least 0.85 shall be achievable.

2.2.1.4 **Recommendation.**— *Means should be provided to maintain the average modulation factor at the highest practicable value without overmodulation.*

2.2.2 Receiving function

2.2.2.1 *Frequency stability.* Where 8.33 kHz channel spacing is introduced in accordance with Volume V, the radio frequency of operation shall not vary more than plus or minus 0.0001 per cent from the assigned frequency.

2.2.2.2 *Sensitivity.* After due allowance has been made for feeder loss and antenna polar diagram variation, the sensitivity of the receiving function shall be such as to provide on a high percentage of occasions an audio output signal with a wanted/unwanted ratio of 15 dB, with a 50 per cent amplitude modulated (A3E) radio signal having a field strength of 20 microvolts per metre (minus 120 dBW/m²) or more.

2.2.2.3 *Effective acceptance bandwidth.* When tuned to a channel having a width of 25 kHz, 50 kHz or 100 kHz, the receiving system shall provide an adequate and intelligible audio output when the signal specified at 2.2.2.2 has a carrier frequency within plus or minus 0.005 per cent of the assigned frequency. When tuned to a channel having a width of 8.33 kHz, the receiving system shall provide an adequate and intelligible audio output when the signal specified at 2.2.2.2 has a carrier frequency within plus or minus 0.0005 per cent of the assigned frequency. Further information on the effective acceptance bandwidth is contained in the Attachment to Part II.

Note.— *The effective acceptance bandwidth includes Doppler shift.*

2.2.2.4 *Adjacent channel rejection.* The receiving system shall ensure an effective rejection of 60 dB or more at the next assignable channel.

Note.— *The next assignable frequency will normally be plus or minus 50 kHz. Where this channel spacing will not suffice, the next assignable frequency will be plus or minus 25 kHz, or plus or minus 8.33 kHz, implemented in accordance with the provisions of Volume V. It is recognized that in certain areas of the world receivers designed for 25 kHz, 50 kHz or 100 kHz channel spacing may continue to be used.*

2.3 SYSTEM CHARACTERISTICS OF THE AIRBORNE INSTALLATION

2.3.1 Transmitting function

2.3.1.1 *Frequency stability.* The radio frequency of operation shall not vary more than plus or minus 0.005 per cent from the assigned frequency. Where 25 kHz channel spacing is introduced, the radio frequency of operation shall not vary more than plus or minus 0.003 per cent from the assigned frequency. Where 8.33 kHz channel spacing is introduced, the radio frequency of operation shall not vary more than plus or minus 0.0005 per cent from the assigned frequency.

2.3.1.2 *Power.* On a high percentage of occasions, the effective radiated power shall be such as to provide a field strength of at least 20 microvolts per metre (minus 120 dBW/m²) on the basis of free space propagation, at ranges and altitudes appropriate to the operational conditions pertaining to the areas over which the aircraft is operated.

2.3.1.3 *Adjacent channel power.* The amount of power from a 8.33 kHz airborne transmitter under all operating conditions when measured over a 7 kHz channel bandwidth centred on the first 8.33 kHz adjacent channel shall not exceed -45 dB below the transmitter carrier power. The above adjacent channel power shall take into account the typical voice spectrum.

Note.— *The voice spectrum is assumed to be a constant level between 300 and 800 Hz and attenuated by 10 dB per octave above 800 Hz.*

2.3.1.4 *Modulation.* A peak modulation factor of at least 0.85 shall be achievable.

2.3.1.5 **Recommendation.**— *Means should be provided to maintain the average modulation factor at the highest practicable value without overmodulation.*

2.3.2 Receiving function

2.3.2.1 *Frequency stability.* Where 8.33 kHz channel spacing is introduced in accordance with Volume V, the radio frequency of operation shall not vary more than plus or minus 0.0005 per cent from the assigned frequency.

2.3.2.2 SENSITIVITY

2.3.2.2.1 **Recommendation.**— *After due allowance has been made for aircraft feeder mismatch, attenuation loss and antenna polar diagram variation, the sensitivity of the receiving function should be such as to provide on a high percentage of occasions an audio output signal with a wanted/unwanted ratio of 15 dB, with a 50 per cent amplitude modulated (A3E) radio signal having a field strength of 75 microvolts per metre (minus 109 dBW/m²).*

Note.— *For planning extended range VHF facilities, an airborne receiving function sensitivity of 30 microvolts per metre may be assumed.*

2.3.2.3 *Effective acceptance bandwidth for 100 kHz, 50 kHz and 25 kHz channel spacing receiving installations.* When tuned to a channel designated in Volume V as having a width of 25 kHz, 50 kHz or 100 kHz, the receiving function shall ensure an effective acceptance bandwidth as follows:

- a) in areas where offset carrier systems are employed, the receiving function shall provide an adequate audio output when the signal specified at 2.3.2.2 has a carrier frequency within 8 kHz of the assigned frequency;
- b) in areas where offset carrier systems are not employed, the receiving function shall provide an adequate audio output when the signal specified at 2.3.2.2 has a carrier frequency of plus or minus 0.005 per cent of the assigned frequency.

2.3.2.4 *Effective acceptance bandwidth for 8.33 kHz channel spacing receiving installations.* When tuned to a channel designated in Volume V, as having a width of 8.33 kHz, the receiving function shall ensure an effective acceptance bandwidth as follows:

- a) in areas where offset carrier systems are employed, the receiving function shall provide an adequate audio output when the signal specified in 2.3.2.2 has a carrier frequency of plus or minus 2.5 kHz of the assigned frequency; and
- b) in areas where offset carrier systems are not employed, the receiving function shall provide an adequate audio output when the signal specified in 2.3.2.2 has a carrier frequency within plus or minus 0.0005 per cent of the assigned frequency. Further information on the effective acceptance bandwidth is contained in Part II, Attachment A.

Note 1.— The effective acceptance bandwidth includes Doppler shift.

Note 2.— When using offset carrier systems (ref. 2.3.2.3 and 2.3.2.4), receiver performance may become degraded when receiving two or more similar strength offset carrier signals. Caution is therefore advised with the implementation of offset carrier systems.

2.3.2.5 *Adjacent channel rejection.* The receiving function shall ensure an effective adjacent channel rejection as follows:

- a) *8.33 kHz channels:* 60 dB or more at plus or minus 8.33 kHz with respect to the assigned frequency, and 40 dB or more at plus or minus 6.5 kHz;

Note.— The receiver local oscillator phase noise should be sufficiently low to avoid any degradation of the receiver capability to reject off carrier signals. A phase noise level better than minus 99 dBc/Hz 8.33 kHz away from the carrier is necessary to comply with 45 dB adjacent channel rejection under all operating conditions.

- b) *25 kHz channel spacing environment:* 50 dB or more at plus or minus 25 kHz with respect to the assigned frequency and 40 dB or more at plus or minus 17 kHz;
- c) *50 kHz channel spacing environment:* 50 dB or more at plus or minus 50 kHz with respect to the assigned frequency and 40 dB or more at plus or minus 35 kHz;
- d) *100 kHz channel spacing environment:* 50 dB or more at plus or minus 100 kHz with respect to the assigned frequency.

2.3.2.6 **Recommendation.**— *Whenever practicable, the receiving system should ensure an effective adjacent channel rejection characteristic of 60 dB or more at plus or minus 25 kHz, 50 kHz and 100 kHz from the assigned frequency for receiving systems intended to operate in channel spacing environments of 25 kHz, 50 kHz and 100 kHz, respectively.*

Note.— Frequency planning is normally based on an assumption of 60 dB effective adjacent channel rejection at plus or minus 25 kHz, 50 kHz or 100 kHz from the assigned frequency as appropriate to the channel spacing environment.

2.3.2.7 **Recommendation.**— *In the case of receivers complying with 2.3.2.3 or 2.3.2.4 used in areas where offset carrier systems are in force, the characteristics of the receiver should be such that:*

- a) *the audio frequency response precludes harmful levels of audio heterodynes resulting from the reception of two or more offset carrier frequencies;*
- b) *the receiver muting circuits, if provided, operate satisfactorily in the presence of audio heterodynes resulting from the reception of two or more offset carrier frequencies.*

2.3.2.8 VDL — INTERFERENCE IMMUNITY PERFORMANCE

2.3.2.8.1 For equipment intended to be used in independent operations of services applying DSB-AM and VDL technology on board the same aircraft, the receiving function shall provide an adequate and intelligible audio output with a desired signal field strength of not more than 150 microvolts per metre (minus 102 dBW/m²) and with an undesired VDL signal field strength of at least 50 dB above the desired field strength on any assignable channel 100 kHz or more away from the assigned channel of the desired signal.

Note.— This level of VDL interference immunity performance provides a receiver performance consistent with the influence of the VDL RF spectrum mask as specified in Volume III, Part I, 6.3.4 with an effective transmitter/receiver isolation of 68 dB. Better transmitter and receiver performance could result in less isolation required.

2.3.2.8.2 After 1 January 2002, the receiving function of all new installations intended to be used in independent operations of services applying DSB-AM and VDL technology on board the same aircraft shall meet the provisions of 2.3.2.8.1.

2.3.2.8.3 After 1 January 2005, the receiving function of all installations intended to be used in independent operations of services applying DSB-AM and VDL technology on board the same aircraft shall meet the provisions of 2.3.2.8.1, subject to the conditions of 2.3.2.8.4.

2.3.2.8.4 Requirements for mandatory compliance of the provisions of 2.3.2.8.3 shall be made on the basis of regional air navigation agreements which specify the airspace of operation and the implementation timescales.

2.3.2.8.4.1 The agreement indicated in 2.3.2.8.4 shall provide at least two years' notice of mandatory compliance of airborne systems.

2.3.3 Interference immunity performance

2.3.3.1 After 1 January 1998, the VHF communications receiving system shall provide satisfactory performance in the presence of two signal, third-order intermodulation products caused by VHF FM broadcast signals having levels at the receiver input of minus 5 dBm.

2.3.3.2 After 1 January 1998, the VHF communications receiving system shall not be desensitized in the presence of VHF FM broadcast signals having levels at the receiver input of minus 5 dBm.

Note.— Guidance material on immunity criteria to be used for the performance quoted in 2.3.3.1 and 2.3.3.2 is contained in the Attachment to Part II, 1.3.

2.3.3.3 After 1 January 1995, all new installations of airborne VHF communications receiving systems shall meet the provisions of 2.3.3.1 and 2.3.3.2.

2.3.3.4 **Recommendation.**— *Airborne VHF communications receiving systems meeting the immunity performance Standards of 2.3.3.1 and 2.3.3.2 should be placed into operation at the earliest possible date.*

2.4 SINGLE SIDEBAND (SSB) HF COMMUNICATION SYSTEM CHARACTERISTICS FOR USE IN THE AERONAUTICAL MOBILE SERVICE

2.4.1 The characteristics of the air-ground HF SSB system, where used in the Aeronautical Mobile Service, shall be in conformity with the following specifications.

2.4.1.1 FREQUENCY RANGE

2.4.1.1.1 HF SSB installations shall be capable of operation at any SSB carrier (reference) frequency available to the Aeronautical Mobile (R) Service in the band 2.8 MHz to 22 MHz and necessary to meet the approved assignment plan for the region(s) in which the system is intended to operate, and in compliance with the relevant provisions of the Radio Regulations.

Note 1.— See Introduction to Volume V, Chapter 3, and Figures 2-1 and 2-2.*

Note 2.— The ITU World Administrative Radio Conference, Aeronautical Mobile (R) Service, Geneva, 1978, established a new Allotment Plan (Appendix 27, Aer to the Radio Regulations) based on single sideband replacing the earlier double sideband Allotment Plan. The World Radiocommunication Conference 1995 redesignated it as Appendix S.27. Minor editorial changes were made at the World Radiocommunication Conference 1997.

2.4.1.1.2 The equipment shall be capable of operating on integral multiples of 1 kHz.

2.4.1.2 SIDEBAND SELECTION

2.4.1.2.1 The sideband transmitted shall be that on the higher frequency side of its carrier (reference) frequency.

2.4.1.3 CARRIER (REFERENCE) FREQUENCY

2.4.1.3.1 Channel utilization shall be in conformity with the table of carrier (reference) frequencies at 27/16 and the Allotment Plan at 27/186 to 27/207 inclusive (or frequencies established on the basis of 27/21, as may be appropriate) of Appendix S27.

Note.— It is intended that only the carrier (reference) frequency be promulgated in Regional Plans and Aeronautical Publications.

2.4.1.4 CLASSES OF EMISSION AND CARRIER SUPPRESSION

2.4.1.4.1 The system shall utilize the suppressed carrier class of emission J3E (also J7B and J9B as applicable). When SELCAL is employed as specified in Chapter 3 of Part II, the installation shall utilize class H2B emission.

2.4.1.4.2 By 1 February 1982 aeronautical stations and aircraft stations shall have introduced the appropriate class(es) of emission prescribed in 2.4.1.4.1. Effective this date the use of class A3E emission shall be discontinued except as provided in 2.4.1.4.4.

2.4.1.4.3 Until 1 February 1982 aeronautical stations and aircraft stations equipped for single sideband operations shall also be equipped to transmit class H3E emission where required to be compatible with reception by double sideband equipment. Effective this date the use of class H3E emission shall be discontinued except as provided in 2.4.1.4.4.

2.4.1.4.4 **Recommendation.**— *For stations directly involved in coordinated search and rescue operations using the frequencies 3 023 kHz and 5 680 kHz, the class of emission J3E should be used; however, since maritime mobile and land mobile services may be involved, A3E and H3E classes of emission may be used.*

2.4.1.4.5 After 1 April 1981 no new DSB equipment shall be installed.

2.4.1.4.6 Aircraft station transmitters shall be capable of at least 26 dB carrier suppression with respect to peak envelope power (P_p) for classes of emission J3E, J7B or J9B.

* All tables and figures are located at the end of this chapter.

2.4.1.4.7 Aeronautical station transmitters shall be capable of 40 dB carrier suppression with respect to peak envelope power (P_p) for classes of emission J3E, J7B or J9B.

2.4.1.5 AUDIO FREQUENCY BANDWIDTH

2.4.1.5.1 For radiotelephone emissions the audio frequencies shall be limited to between 300 and 2 700 Hz and the occupied bandwidth of other authorized emissions shall not exceed the upper limit of J3E emissions. In specifying these limits, however, no restriction in their extension shall be implied in so far as emissions other than J3E are concerned, provided that the limits of unwanted emissions are met (see 2.4.1.7).

Note.— For aircraft and aeronautical station transmitter types first installed before 1 February 1983 the audio frequencies will be limited to 3 000 Hz.

2.4.1.5.2 For other authorized classes of emission the modulation frequencies shall be such that the required spectrum limits of 2.4.1.7 will be met.

2.4.1.6 FREQUENCY TOLERANCE

2.4.1.6.1 The basic frequency stability of the transmitting function for classes of emission J3E, J7B or J9B shall be such that the difference between the actual carrier of the transmission and the carrier (reference) frequency shall not exceed:

- 20 Hz for airborne installations;
- 10 Hz for ground installations.

2.4.1.6.2 The basic frequency stability of the receiving function shall be such that, with the transmitting function stabilities specified in 2.4.1.6.1, the overall frequency difference between ground and airborne functions achieved in service and including Doppler shift, does not exceed 45 Hz. However, a greater frequency difference shall be permitted in the case of supersonic aircraft.

2.4.1.7 SPECTRUM LIMITS

2.4.1.7.1 For aircraft station transmitter types and for aeronautical station transmitters first installed before 1 February 1983 and using single sideband classes of emission H2B, H3E, J3E, J7B or J9B the mean power of any emission on any discrete frequency shall be less than the mean power (P_m) of the transmitter in accordance with the following:

- on any frequency removed by 2 kHz or more up to 6 kHz from the assigned frequency: at least 25 dB;
- on any frequency removed by 6 kHz or more up to 10 kHz from the assigned frequency: at least 35 dB;
- on any frequency removed from the assigned frequency by 10 kHz or more:
 - a) aircraft station transmitters: 40 dB;
 - b) aeronautical station transmitters:

$$[43 + 10 \log_{10} P_m (W)] \text{ dB}$$

2.4.1.7.2 For aircraft station transmitters first installed after 1 February 1983 and for aeronautical station transmitters in use as of 1 February 1983 and using single sideband classes of emission H2B, H3E, J3E, J7B or J9B, the peak envelope power (P_p) of any emission on any discrete frequency shall be less than the peak envelope power (P_p) of the transmitter in accordance with the following:

- on any frequency removed by 1.5 kHz or more up to 4.5 kHz from the assigned frequency: at least 30 dB;
- on any frequency removed by 4.5 kHz or more up to 7.5 kHz from the assigned frequency: at least 38 dB;
- on any frequency removed from the assigned frequency by 7.5 kHz or more:
 - a) aircraft station transmitters: 43 dB;
 - b) aeronautical station transmitters: for transmitter power up to and including 50 W:

$$[43 + 10 \log_{10} P_p (W)] \text{ dB}$$

For transmitter power more than 50 W: 60 dB.

Note.— See Figures 2-1 and 2-2.

2.4.1.8 POWER

2.4.1.8.1 *Aeronautical station installations.* Except as permitted by the relevant provisions of Appendix S27 to the ITU Radio Regulations, the peak envelope power (P_p) supplied to the antenna transmission line for H2B, H3E, J3E, J7B or J9B classes of emissions shall not exceed a maximum value of 6 kW.

2.4.1.8.2 *Aircraft station installations.* The peak envelope power supplied to the antenna transmission line for H2B, H3E, J3E, J7B or J9B classes of emission shall not exceed 400 W except as provided for in Appendix S27 of the ITU Radio Regulations as follows:

S27/68 It is recognized that the power employed by aircraft transmitters may, in practice, exceed the limits specified in No. 27/60. However, the use of such increased power (which normally should not exceed $600 W P_p$) shall not cause harmful interference to stations using frequencies in accordance with the technical principles on which the Allotment Plan is based.

S27/60 Unless otherwise specified in Part II of this Appendix, the peak envelope powers supplied to the antenna transmission line shall not exceed the maximum values indicated in the table below; the corresponding peak effective radiated powers being assumed to be equal to two-thirds of these values:

<i>Class of emission</i>	<i>Stations</i>	<i>Max. peak envelope power (P_p)</i>
H2B, J3E, J7B, J9B, A3E*, H3E* (100% modulation)	Aeronautical stations Aircraft stations	6 kW 400 W
Other emission such as A1A, F1B	Aeronautical stations Aircraft stations	1.5 kW 100 W

* A3E and H3E to be used only on 3 023 kHz and 5 680 kHz.

2.4.1.9 *Method of operation.* Single channel simplex shall be employed.

2.5 SATELLITE VOICE COMMUNICATION (SATVOICE) SYSTEM CHARACTERISTICS

Note.— Guidance material for the implementation of the aeronautical mobile satellite service is contained in the Manual on the Aeronautical Mobile Satellite (Route) Service (Doc 9925). Additional guidance for SATVOICE systems is contained in the Satellite Voice Operations Manual (Doc 10038), and the Performance-based Communication and Surveillance (PBCS) Manual (Doc 9869).

2.5.1 For ground-to-air calls, the SATVOICE system shall be capable of contacting the aircraft and enabling the ground party/system to provide, as a minimum, the following:

- a) secure calling;
- b) priority level as defined in Table 2-1; and
- c) aircraft SATVOICE number, which is the aircraft address expressed as an 8-digit octal number.

2.5.2 For ground-to-air calls, the SATVOICE system shall be capable of locating the aircraft in the appropriate airspace regardless of the satellite and ground earth station (GES) to which the aircraft is logged on.

2.5.3 For air-to-ground calls, the SATVOICE system shall be capable of:

- a) contacting the aeronautical station via an assigned SATVOICE number, which is a unique 6-digit number or public switched telephone network (PSTN) number; and
- b) allowing the flight crew and/or aircraft system to specify the priority level for the call as defined in Table 2-1.

TABLE FOR CHAPTER 2

Table 2-1. Priority levels for SATVOICE calls (air-to-ground/ground-to-air)

Priority level	Application category
1 / EMG / Q15 Emergency (highest) Safety of flight	Distress and urgency. For use by flight crew, when appropriate.
2 / HGH / Q12 Operational high (second highest) Safety of flight	Flight safety. Typically assigned to calls between aircraft and ANSPs.
3 / LOW / Q10 Operational low (third highest) Safety of flight	Regularity of flight, meteorological, administrative. Typically assigned to calls between aircraft operators and their aircraft.
4 / PUB / Q9 Non-operational (lowest) Non safety	Public correspondence.

FIGURES FOR CHAPTER 2

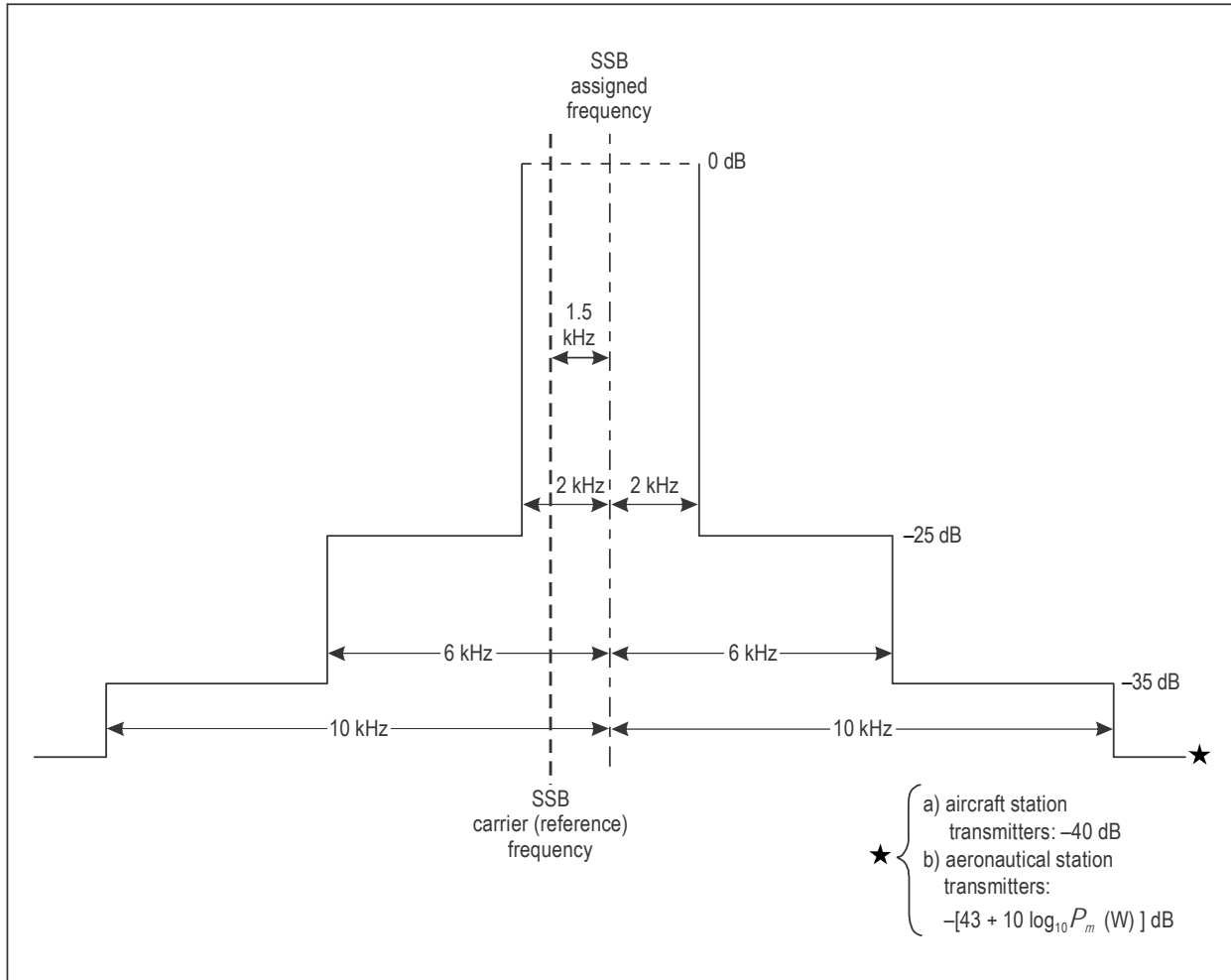

Figure 2-1. Required spectrum limits (in terms of mean power) for aircraft station transmitter types and for aeronautical station transmitters first installed before 1 February 1983

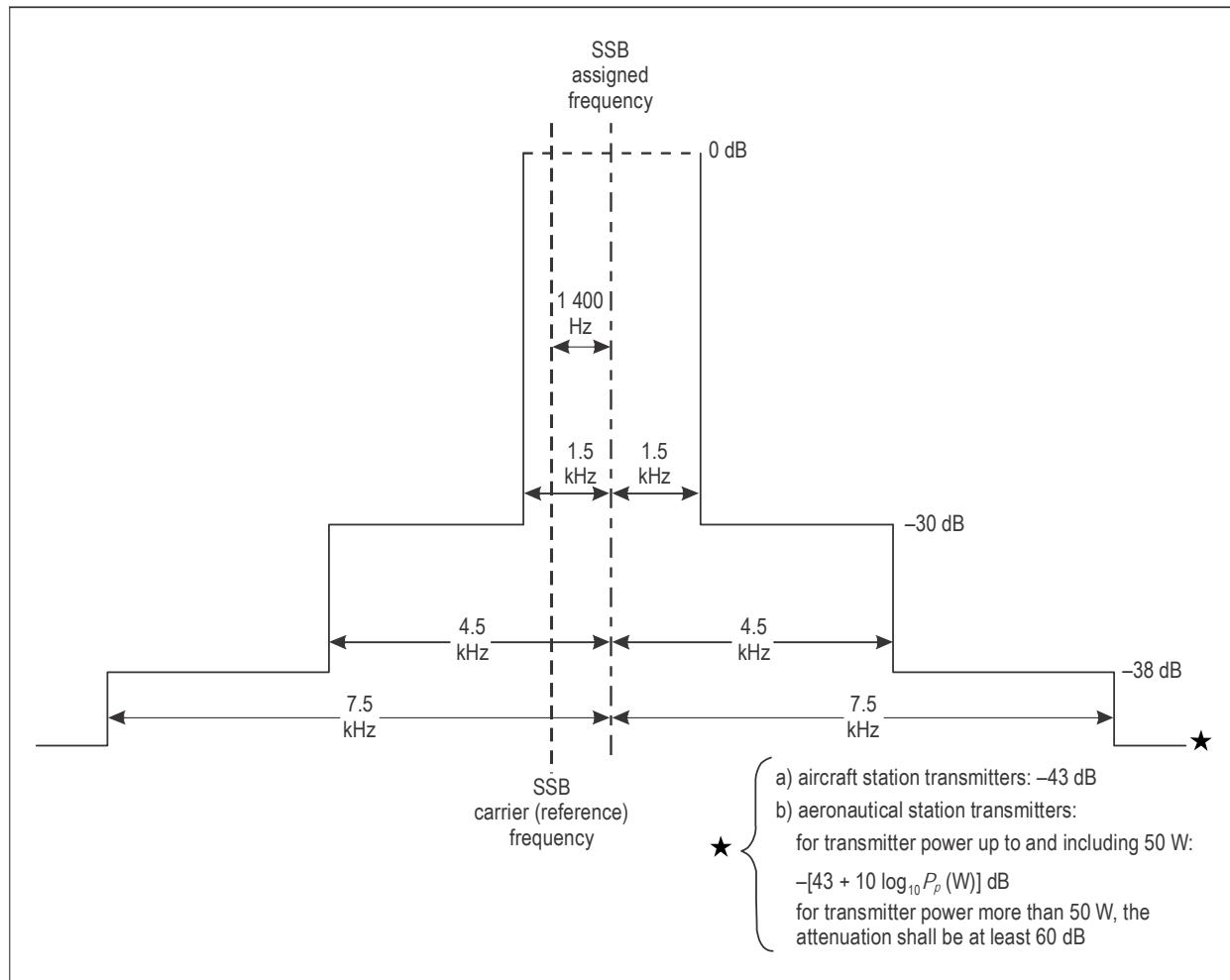

Figure 2-2. Required spectrum limits (in terms of peak power) for aircraft station transmitters first installed after 1 February 1983 and aeronautical station transmitters in use after 1 February 1983

CHAPTER 3. SELCAL SYSTEM

3.1 **Recommendation.**— *Until 2 November 2022, where a SELCAL system is installed, the following system characteristics should be applied:*

- a) *Transmitted code. Each transmitted code should be made up of two consecutive tone pulses, with each pulse containing two simultaneously transmitted tones. The pulses should be of 1.0 plus or minus 0.25 seconds duration, separated by an interval of 0.2 plus or minus 0.1 second.*
- b) *Stability. The frequency of transmitted tones should be held to plus or minus 0.15 per cent tolerance to ensure proper operation of the airborne decoder.*
- c) *Distortion. The overall audio distortion present on the transmitted RF signal should not exceed 15 per cent.*
- d) *Per cent modulation. The RF signal transmitted by the ground radio station should contain, within 3 dB, equal amounts of the two modulating tones. The combination of tones should result in a modulation envelope having a nominal modulation percentage as high as possible and in no case less than 60 per cent.*
- e) *Transmitted tones. Tone codes should be made up of various combinations of the tones listed in the following table and designated by colour and letter as indicated:*

<i>Designation</i>	<i>Frequency (Hz)</i>
<i>Red A</i>	<i>312.6</i>
<i>Red B</i>	<i>346.7</i>
<i>Red C</i>	<i>384.6</i>
<i>Red D</i>	<i>426.6</i>
<i>Red E</i>	<i>473.2</i>
<i>Red F</i>	<i>524.8</i>
<i>Red G</i>	<i>582.1</i>
<i>Red H</i>	<i>645.7</i>
<i>Red J</i>	<i>716.1</i>
<i>Red K</i>	<i>794.3</i>
<i>Red L</i>	<i>881.0</i>
<i>Red M</i>	<i>977.2</i>
<i>Red P</i>	<i>1 083.9</i>
<i>Red Q</i>	<i>1 202.3</i>
<i>Red R</i>	<i>1 333.5</i>
<i>Red S</i>	<i>1 479.1</i>

Note 1.— It should be noted that the tones are spaced by $\text{Log}^{-1} 0.045$ to avoid the possibility of harmonic combinations.

Note 2.— In accordance with the application principles developed by the Sixth Session of the Communications Division, the only codes at present used internationally are selected from the red group.

Note 3.— Guidance material on the use of SELCAL systems is contained in the Attachment to Part II.

Note 4.— The tones Red P, Red Q, Red R, and Red S are applicable after 1 September 1985, in accordance with 3.2.

3.2 Until 2 November 2022, aeronautical stations which are required to communicate with SELCAL-equipped aircraft shall have SELCAL encoders in accordance with the red group in the table of tone frequencies of 3.1. After 1 September 1985, SELCAL codes using the tones Red P, Red Q, Red R, and Red S may be assigned.

3.1 As of 3 November 2022, where a SELCAL system is installed, the following system characteristics shall be applied:

- a) Transmitted code. Each transmitted code shall be made up of two consecutive tone pulses, with each pulse containing two simultaneously transmitted tones. The pulses shall be of 1.0 plus or minus 0.25 seconds duration, separated by an interval of 0.2 plus or minus 0.1 second.
- b) Frequency stability. The frequency of transmitted tones shall be held to plus or minus 0.15 per cent tolerance to ensure proper operation of the airborne decoder.
- c) Distortion. The overall audio distortion present on the transmitted RF signal shall not exceed 15 per cent.
- d) Level stability. The RF signal transmitted by the ground radio station shall contain, within 3 dB, equal amounts of the two modulating tones.

3.1.1 **Recommendation.**— *As of 3 November 2022, modulation envelope. The combination of tones should result in a modulation envelope having a nominal modulation percentage as high as possible and not less than 60 per cent.*

3.2 As of 3 November 2022, the transmitted codes shall be made up of various combinations of the tones listed in Table 3-1. They are designated by colour and letter or number as indicated:

**Table 3-1. SELCAL tones designated by colour and letter or number
(applicable as of 3 November 2022)**

<i>Designation</i>	<i>Frequency (Hz)</i>
<i>Red A</i>	<i>312.6</i>
<i>Red B</i>	<i>346.7</i>
<i>Red C</i>	<i>384.6</i>
<i>Red D</i>	<i>426.6</i>
<i>Red E</i>	<i>473.2</i>
<i>Red F</i>	<i>524.8</i>
<i>Red G</i>	<i>582.1</i>
<i>Red H</i>	<i>645.7</i>
<i>Red J</i>	<i>716.1</i>
<i>Red K</i>	<i>794.3</i>
<i>Red L</i>	<i>881.0</i>
<i>Red M</i>	<i>977.2</i>
<i>Red P</i>	<i>1083.9</i>
<i>Red Q</i>	<i>1202.3</i>
<i>Red R</i>	<i>1333.5</i>
<i>Red S</i>	<i>1479.1</i>
<i>Red T</i>	<i>329.2</i>
<i>Red U</i>	<i>365.2</i>
<i>Red V</i>	<i>405.0</i>
<i>Red W</i>	<i>449.3</i>
<i>Red X</i>	<i>498.3</i>

<i>Designation</i>	<i>Frequency (Hz)</i>
<i>Red Y</i>	<i>552.7</i>
<i>Red Z</i>	<i>613.1</i>
<i>Red 1</i>	<i>680.0</i>
<i>Red 2</i>	<i>754.2</i>
<i>Red 3</i>	<i>836.6</i>
<i>Red 4</i>	<i>927.9</i>
<i>Red 5</i>	<i>1 029.2</i>
<i>Red 6</i>	<i>1 141.6</i>
<i>Red 7</i>	<i>1 266.2</i>
<i>Red 8</i>	<i>1 404.4</i>
<i>Red 9</i>	<i>1 557.8</i>

Note 1.— The frequencies of the tones are spaced by $\text{Log}^{-1} 0.0225$ to avoid the possibility of harmonic combinations.

Note 2.— In accordance with the application principles developed by the Sixth Session of the Communications Division, the only codes at present used internationally are selected from the red group.

Note 3.— Guidance material on the use of SELCAL systems is contained in the Attachment to Part II.

3.3 As of 3 November 2022, aeronautical stations which are required to communicate with SELCAL-equipped aircraft shall have SELCAL encoders that support all tones in accordance with Table 3-1.

3.4 As of 3 November 2022, SELCAL codes using the tones Red T through Red 9 as given in Table 3-1 shall only be assigned to SELCAL-equipped aircraft with the capability of receiving these tones.

CHAPTER 4. AERONAUTICAL SPEECH CIRCUITS

4.1 TECHNICAL PROVISIONS RELATING TO INTERNATIONAL AERONAUTICAL SPEECH CIRCUIT SWITCHING AND SIGNALLING FOR GROUND-GROUND APPLICATIONS

Note.— *Guidance material on the implementation of aeronautical speech circuit switching and signalling for ground-ground applications is contained in the Manual on Air Traffic Services (ATS) Ground-Ground Voice Switching and Signalling (Doc 9804). The material includes explanation of terms, performance parameters, guidance on basic call types and additional functions, references to appropriate ISO/IEC international standards and ITU-T recommendations, guidance on the use of signalling systems, details of the recommended numbering scheme and guidance on migration to future schemes.*

4.1.1 The use of circuit switching and signalling to provide speech circuits to interconnect ATS units not interconnected by dedicated circuits shall be by agreement between the Administrations concerned.

4.1.2 The application of aeronautical speech circuit switching and signalling shall be made on the basis of regional air navigation agreements.

4.1.3 **Recommendation.**— *The ATC communication requirements defined in Annex 11, Section 6.2 should be met by implementation of one or more of the following basic three call types:*

- a) instantaneous access;*
- b) direct access; and*
- c) indirect access.*

4.1.4 **Recommendation.**— *In addition to the ability to make basic telephone calls, the following functions should be provided in order to meet the requirements set out in Annex 11:*

- a) means of indicating the calling/called party identity;*
- b) means of initiating urgent/priority calls; and*
- c) conference capabilities.*

4.1.5 **Recommendation.**— *The characteristics of the circuits used in aeronautical speech circuit switching and signalling should conform to appropriate ISO/IEC international standards and ITU-T recommendations.*

4.1.6 **Recommendation.**— *Digital signalling systems should be used wherever their use can be justified in terms of any of the following:*

- a) improved quality of service;*
- b) improved user facilities; or*

c) *reduced costs where quality of service is maintained.*

4.1.7 **Recommendation.**— *The characteristics of supervisory tones to be used (such as ringing, busy, number unobtainable) should conform to appropriate ITU-T recommendations.*

4.1.8 **Recommendation.**— *To take advantage of the benefits of interconnecting regional and national aeronautical speech networks, the international aeronautical telephone network numbering scheme should be used.*

CHAPTER 5. EMERGENCY LOCATOR TRANSMITTER (ELT) FOR SEARCH AND RESCUE

5.1 GENERAL

5.1.1 Until 1 January 2005, emergency locator transmitters shall operate either on both 406 MHz and 121.5 MHz or on 121.5 MHz.

Note.— From 1 January 2000, ELTs operating on 121.5 MHz will be required to meet the improved technical characteristics contained in 5.2.1.8.

5.1.2 All installations of emergency locator transmitters operating on 406 MHz shall meet the provisions of 5.3.

5.1.3 All installations of emergency locator transmitters operating on 121.5 MHz shall meet the provisions of 5.2.

5.1.4 From 1 January 2005, emergency locator transmitters shall operate on 406 MHz and 121.5 MHz simultaneously.

5.1.5 All emergency locator transmitters installed on or after 1 January 2002 shall operate simultaneously on 406 MHz and 121.5 MHz.

5.1.6 The technical characteristics for the 406 MHz component of an integrated ELT shall be in accordance with 5.3.

5.1.7 The technical characteristics for the 121.5 MHz component of an integrated ELT shall be in accordance with 5.2.

5.1.8 States shall make arrangements for a 406 MHz ELT register. Register information regarding the ELT shall be immediately available to search and rescue authorities. States shall ensure that the register is updated whenever necessary.

5.1.9 ELT register information shall include the following:

- a) transmitter identification (expressed in the form of an alphanumeric code of 15 hexadecimal characters);
- b) transmitter manufacturer, model and, when available, manufacturer's serial number;
- c) COSPAS-SARSAT* type approval number;
- d) name, address (postal and e-mail) and emergency telephone number of the owner and operator;
- e) name, address (postal and e-mail) and telephone number of other emergency contacts (two, if possible) to whom the owner or the operator is known;
- f) aircraft manufacturer and type; and
- g) colour of the aircraft.

* COSPAS = Space system for search of vessels in distress;
SARSAT = Search and rescue satellite-aided tracking.

Note 1.— Various coding protocols are available to States. Depending on the protocol adopted, States may, at their discretion, include one of the following as supplementary identification information to be registered:

- a) aircraft operating agency designator and operator's serial number; or*
- b) 24-bit aircraft address; or*
- c) aircraft nationality and registration marks.*

The aircraft operating agency designator is allocated to the operator by ICAO through the State administration, and the operator's serial number is allocated by the operator from the block 0001 to 4096.

Note 2.— At their discretion, depending on arrangements in place, States may include other relevant information to be registered such as the last date of register, battery expiry date and place of ELT in the aircraft (e.g. "primary ELT" or "life-raft No. 1").

5.2 SPECIFICATION FOR THE 121.5 MHz COMPONENT OF EMERGENCY LOCATOR TRANSMITTER (ELT) FOR SEARCH AND RESCUE

Note 1.— Information on technical characteristics and operational performance of 121.5 MHz ELTs is contained in RTCA Document DO-183 and European Organization for Civil Aviation Equipment (EUROCAE) Document ED.62.

Note 2.— Technical characteristics of emergency locator transmitters operating on 121.5 MHz are contained in ITU-R Recommendation M.690-1. The ITU designation for an ELT is Emergency Position — Indicating Radio Beacon (EPIRB).

5.2.1 Technical characteristics

5.2.1.1 Emergency locator transmitters (ELT) shall operate on 121.5 MHz. The frequency tolerance shall not exceed plus or minus 0.005 per cent.

5.2.1.2 The emission from an ELT under normal conditions and attitudes of the antenna shall be vertically polarized and essentially omnidirectional in the horizontal plane.

5.2.1.3 Over a period of 48 hours of continuous operation, at an operating temperature of minus 20°C, the peak effective radiated power (PERP) shall at no time be less than 50 mW.

5.2.1.4 The type of emission shall be A3X. Any other type of modulation that meets the requirements of 5.2.1.5, 5.2.1.6 and 5.2.1.7 may be used provided that it will not prejudice precise location of the beacon by homing equipment.

Note.— Some ELTs are equipped with an optional voice capability (A3E) in addition to the A3X emission.

5.2.1.5 The carrier shall be amplitude modulated at a modulation factor of at least 0.85.

5.2.1.6 The modulation applied to the carrier shall have a minimum duty cycle of 33 per cent.

5.2.1.7 The emission shall have a distinctive audio characteristic achieved by amplitude modulating the carrier with an audio frequency sweeping downward over a range of not less than 700 Hz within the range 1 600 Hz to 300 Hz and with a sweep repetition rate of between 2 Hz and 4 Hz.

5.2.1.8 After 1 January 2000, the emission shall include a clearly defined carrier frequency distinct from the modulation sideband components; in particular, at least 30 per cent of the power shall be contained at all times within plus or minus 30 Hz of the carrier frequency on 121.5 MHz.

5.3 SPECIFICATION FOR THE 406 MHz COMPONENT OF EMERGENCY LOCATOR TRANSMITTER (ELT) FOR SEARCH AND RESCUE

5.3.1 Technical characteristics

Note 1.— Transmission characteristics for 406 MHz emergency locator transmitters are contained in ITU-R M.633.

Note 2.— Information on technical characteristics and operational performance of 406 MHz ELTs is contained in RTCA Document DO-204 and European Organization for Civil Aviation Equipment (EUROCAE) Document ED-62.

5.3.1.1 Emergency locator transmitters shall operate on one of the frequency channels assigned for use in the frequency band 406.0 to 406.1 MHz.

Note.— The COSPAS-SARSAT 406 MHz channel assignment plan is contained in COSPAS-SARSAT Document C/S T.012.

5.3.1.2 The period between transmissions shall be 50 seconds plus or minus 5 per cent.

5.3.1.3 Over a period of 24 hours of continuous operation at an operating temperature of -20°C , the transmitter power output shall be within the limits of 5 W plus or minus 2 dB.

5.3.1.4 The 406 MHz ELT shall be capable of transmitting a digital message.

5.3.2 Transmitter identification coding

5.3.2.1 Emergency locator transmitters operating on 406 MHz shall be assigned a unique coding for identification of the transmitter or aircraft on which it is carried.

5.3.2.2 The emergency locator transmitter shall be coded in accordance with either the aviation user protocol or one of the serialized user protocols described in the Appendix to this chapter, and shall be registered with the appropriate authority.

APPENDIX TO CHAPTER 5.
EMERGENCY LOCATOR TRANSMITTER CODING
(see Chapter 5, 5.3.2)

Note.— A detailed description of beacon coding is contained in Specification for COSPAS-SARSAT 406 MHz Distress Beacons (C/S T.001). The following technical specifications are specific to emergency locator transmitters used in aviation.

1. GENERAL

1.1 The emergency locator transmitter (ELT) operating on 406 MHz shall have the capacity to transmit a programmed digital message which contains information related to the ELT and/or the aircraft on which it is carried.

1.2 The ELT shall be uniquely coded in accordance with 1.3 and be registered with the appropriate authority.

1.3 The ELT digital message shall contain either the transmitter serial number or one of the following information elements:

- a) aircraft operating agency designator and a serial number;
- b) 24-bit aircraft address;
- c) aircraft nationality and registration marks.

1.4 All ELTs shall be designed for operation with the COSPAS-SARSAT* system and be type approved.

Note.— Transmission characteristics of the ELT signal can be confirmed by making use of the COSPAS-SARSAT Type Approval Standard (C/S T.007).

2. ELT CODING

2.1 The ELT digital message shall contain information relating to the message format, coding protocol, country code, identification data and location data, as appropriate.

2.2 For ELTs with no navigation data provided, the short message format C/S T.001 shall be used, making use of bits 1 through 112. For ELTs with navigation data, if provided, the long message format shall be used, making use of bits 1 through 144.

2.3 Protected data field

2.3.1 The protected data field consisting of bits 25 through 85 shall be protected by an error correcting code and shall be the portion of the message which shall be unique in every distress ELT.

2.3.2 A message format flag indicated by bit 25 shall be set to “0” to indicate the short message format or set to “1” to indicate the long format for ELTs capable of providing location data.

* COSPAS = Space system for search of vessels in distress;
SARSAT = Search and rescue satellite-aided tracking.

2.3.3 A protocol flag shall be indicated by bit 26 and shall be set to “1” for user and user location protocols, and “0” for location protocols.

2.3.4 A country code, which indicates the State where additional data are available on the aircraft on which the ELT is carried, shall be contained in bits 27 through 36 which designate a three-digit decimal country code number expressed in binary notation.

Note.— Country codes are based on the International Telecommunication Union (ITU) country codes shown in Table 4 of Part I, Volume I of the ITU List of Call Signs and Numerical Identities.

2.3.5 Bits 37 through 39 (user and user location protocols) or bits 37 through 40 (location protocols) shall designate one of the protocols where values “001” and “011” or “0011”, “0100”, “0101”, and “1000” are used for aviation as shown in the examples contained in this appendix.

2.3.6 The ELT digital message shall contain either the transmitter serial number or an identification of the aircraft or operator as shown below.

2.3.7 In the serial user and serial user location protocol (designated by bit 26=1 and bits 37 through 39 being “011”), the serial identification data shall be encoded in binary notation with the least significant bit on the right. Bits 40 through 42 shall indicate type of ELT serial identification data encoded where:

- “000” indicates ELT serial number (binary notation) is encoded in bits 44 through 63;
- “001” indicates aircraft operator (3 letter encoded using modified Baudot code shown in Table 5-1) and a serial number (binary notation) are encoded in bits 44 through 61 and 62 through 73, respectively;
- “011” indicates the 24-bit aircraft address is encoded in bits 44 through 67 and each additional ELT number (binary notation) on the same aircraft is encoded in bits 68 through 73.

Note.— States will ensure that each beacon, coded with the country code of the State, is uniquely coded and registered in a database. Unique coding of serialized coded beacons can be facilitated by including the COSPAS-SARSAT Type Approval Certificate Number which is a unique number assigned by COSPAS-SARSAT for each approved ELT model, as part of the ELT message.

2.3.8 In the aviation user or user location protocol (designated by bit 26=1 and bits 37 through 39 being “001”), the aircraft nationality and registration marking shall be encoded in bits 40 through 81, using the modified Baudot code shown in Table 5-1 to encode seven alphanumeric characters. This data shall be right justified with the modified Baudot “space” (“100100”) being used where no character exists.

2.3.9 Bits 84 and 85 (user or user location protocol) or bit 112 (location protocols) shall indicate any homing transmitter that may be integrated in the ELT.

2.3.10 In standard and national location protocols, all identification and location data shall be encoded in binary notation with the least significant bit right justified. The aircraft operator designator (3 letter code) shall be encoded in 15 bits using a modified Baudot code (Table 5-1) using only the 5 right most bits per letter and dropping the left most bit which has a value of 1 for letters.

Table 5-1. Modified Baudot code

<i>Letter</i>	<i>Code</i>		<i>Figure</i>	<i>Code</i>	
	<i>MSB</i>	<i>LSB</i>		<i>MSB</i>	<i>LSB</i>
A	111000		(-)*	011000	
B	110011				
C	101110				
D	110010				
E	110000		3	010000	
F	110110				
G	101011				
H	100101				
I	101100				
J	111010		8	001100	
K	111110				
L	101001				
M	100111				
N	100110				
O	100011		9	000011	
P	101101		0	001101	
Q	111101		1	011101	
R	101010		4	001010	
S	110100				
T	100001		5	000001	
U	111100		7	011100	
V	101111				
W	111001		2	011001	
X	110111		/	010111	
Y	110101		6	010101	
Z	110001				
()**	100100				

MSB = most significant bit

LSB = least significant bit

* = hyphen

** = space

EXAMPLES OF CODING

ELT serial number

25		27	36	37		40		44		63	64	73	74	83		85
F	1	COUNTRY	0	1	1	T	T	T	C	SERIAL NUMBER DATA (20 BITS)	SEE NOTE 1	SEE NOTE 2	A	A		

Aircraft address

25		27	36	37		40		44		67	68	73	74	83		85
F	1	COUNTRY	0	1	1	T	T	T	C	AIRCRAFT ADDRESS (24 BITS)	SEE NOTE 3	SEE NOTE 2	A	A		

Aircraft operator designator and serial number

25		27	36	37		40		44		61	62	73	74	83		85
F	1	COUNTRY	0	1	1	T	T	T	C	OPERATOR 3-LETTER DESIGNATOR	SERIAL NUMBER 1-4096	SEE NOTE 2	A	A		

Aircraft registration marking

25		27	36	37		40							81	83		85
F	1	COUNTRY	0	0	1	AIRCRAFT REGISTRATION MARKING (UP TO 7 ALPHANUMERIC CHARACTERS) (42 BITS)							0	0	A	A

- T = Beacon type TTT: = 000 indicates ELT serial number is encoded;
 = 001 indicates operating agency and serial number are encoded;
 = 011 indicates 24-bit aircraft address is encoded.
- C = Certificate flag bit: 1 = to indicate that COSPAS-SARSAT Type Approval Certificate number is encoded in bits
 74 through 83 and
 0 = otherwise
- F = Format flag: 0 = Short Message
 1 = Long Message
- A = Auxiliary radio-locating device: 00 = no auxiliary radio-locating device
 01 = 121.5 MHz
 11 = other auxiliary radio-locating device

Note 1.— 10 bits, all 0s or National use.

Note 2.— COSPAS-SARSAT Type Approval Certificate number in binary notation with the least significant bit on the right, or National use.

Note 3.— Serial number, in binary notation with the least significant bit on the right, of additional ELTs carried in the same aircraft or default to 0s when only one ELT is carried.

EXAMPLE OF CODING (USER LOCATION PROTOCOL)

25	26	←27	←37	←40		85→	←86	←107	←113			←133			
		36→	39→	83→			106→	112→	132→			144→			
1	1	10	3	44		2	21		1	12		13	12		
1	1	CC	T	IDENTIFICATION DATA (AS IN ANY OF USER PROTOCOLS ABOVE)		A	21-BIT BCH ERROR CORRECTING CODE		E	LATITUDE		LONGITUDE		12-BIT BCH ERROR CORRECTING CODE	
										1	7	4	1	8	4
										N	DEG	MIN	E	DEG	MIN
										/	0-90	0-56	/	0-180	0-56
										S	(1 d)	(4m)	W	(1 d)	(4m)

CC = Country Code;

E = Encoded position data source: 1 = Internal navigation device, 0 = External navigation device

EXAMPLE OF CODING (STANDARD LOCATION PROTOCOL)

25	26	←27	←37	←41		85→	←86	107	112	←113			←133	144→				
		36→	40→	41→			106→			132→								
← 61 BITS							← 26 BITS											
1	1	10	4	45			21	6	20						12			
1	0	CC	PC	IDENTIFICATION DATA		LATITUDE		LONGITUDE		21-BIT BCH CODE	SD	Δ LATITUDE		Δ LONGITUDE		12-BIT BCH CODE		
				24		1	9	1	10			1	5	4	1		5	4
			0011	AIRCRAFT 24 BIT ADDRESS		N = 0	LAT	E = 0	LON			- = 0	M	S	- = 0		M	S
							DEG		DEG			+ = 1	U	O	+ = 1		U	O
			0101	15	9	S = 1	0-90	W = 1	0-180									
				AIRCRAFT OPER. DESIGNATOR								0-30	0-56	0-30	0-56			
				10	14		(1/4 d)		(1/4 d)			(1 m)	(4 s)	(1 m)	(4 s)			
			0100	C/STA No 1-1023		SERIAL No 1-16383												

CC = Country Code;

PC = Protocol Code 0011 indicates 24-bit aircraft address is encoded;
 0101 indicates operating agency and serial number are encoded;
 0100 indicates ELT serial number is encoded.

SD = Supplementary Data bits 107 – 110 = 1101;
 bit 111 = Encoded Position Data Source (1 = internal; 0 = external)
 bit 112: 1 = 121.5 MHz auxiliary radio locating device;
 0 = other or no auxiliary radio locating device.

Note 1.— Further details on protocol coding can be found in Specification for COSPAS-SARSAT 406 MHz Distress Beacon (C/S T.001).

Note 2.— All identification and location data are to be encoded in binary notation with the least significant bit on the right except for the aircraft operator designator (3 letter code).

Note 3.— For details on BCH error correcting code see Specification for COSPAS-SARSAT 406 MHz Distress Beacon (C/S T.001).

EXAMPLE OF CODING (NATIONAL LOCATION PROTOCOL)

25	26	←27	←37											←86	107	←113											←133				
		36→	40→ ←41											85→	106→	112											132→	144→			
61 BITS PDF-1														BCH-1	26 BITS PDF-2														BCH-2		
1	1	10	4	45										21	6	7							7							6	12
1	0	CC	1000	18 bits	27 bits										21-BIT BCH CODE	SD	Δ LATITUDE						Δ LONGITUDE						NU	12-BIT BCH CODE	
				ID	LATITUDE					LONGITUDE																					
				18	1	7	5	1	8	5	1	2	4	1			2	4													
				NATIONAL ID NUMBER	N = 0 S = 1	D E G R E E S	M I N U T E S	E = 0 W = 1	D E G R E E S	M I N U T E S	0-90 (1 d)	0-58 (2 m)	0-180 (1 d)	0-58 (2 m)			- = 0 + = 1	M I N U T E S	S E C O N D S	- = 0 + = 1	M I N U T E S	S E C O N D S	0-3 (1 m)	0-56 (4 s)	0-3 (1 m)	0-56 (4 s)					

- CC = Country Code;
- ID = Identification Data = 8-bit identification data consisting of a serial number assigned by the appropriate national authority
- SD = Supplementary Data = bits 107 – 109 = 110;
 bit 110 = Additional Data Flag describing the use of bits 113 to 132:
 1 = Delta position; 0 = National assignment;
 bit 111 = Encoded Position Data Source: 1 = internal, 0 = external;
 bit 112: 1 = 121.5 MHz auxiliary radio locating device;
 0 = other or no device
- NU = National use = 6 bits reserved for national use (additional beacon type identification or other uses).

Note 1.— Further details on protocol coding can be found in Specification for COSPAS-SARSAT 406 MHz Distress Beacon (C/S T.001).

Note 2.— All identification and location data are to be encoded in binary notation with the least significant bit on the right.

Note 3.— For details on BCH error correcting code see Specification for COSPAS-SARSAT 406 MHz Distress Beacon (C/S T.001).

ATTACHMENT TO PART I. GUIDANCE MATERIAL FOR THE VHF DIGITAL LINK (VDL)

1. GUIDANCE MATERIAL FOR THE VHF DIGITAL LINK (VDL)

Note.— The Standards and Recommended Practices (SARPs) referred to are contained in Annex 10, Volume III, Part I, Chapter 6.

2. SYSTEM DESCRIPTION

2.1 The VDL system provides an air-ground data communications link within the aeronautical telecommunications network (ATN). The VDL will operate in parallel with the other ATN air-ground subnetworks.

2.2 VDL ground stations consist of a VHF radio and a computer capable of handling the VDL protocol throughout the coverage area. The VDL stations offer connectivity via a ground-based telecommunications network (e.g. X.25 based) to ATN intermediate systems which will provide access to ground-based ATN end systems.

2.3 In order to communicate with the VDL ground stations, aircraft are required to be equipped with VDL avionics which will include a VHF radio and a computer capable of handling the VDL protocol. The air-ground communication will utilize 25 kHz channels in the VHF aeronautical mobile (route) service band.

3. VDL PRINCIPLES

3.1 Communications transfer principles

3.1.1 Connectivity between applications running in ATN end systems (ES) using the ATN and its subnetworks, including the VDL, for air-ground communication is provided by the transport layer entities in these end systems. Transport connections between airborne and ground end systems shall be maintained through controlled changes of the precise ATN intermediate systems (IS) and VDL network elements that provide this connectivity.

3.1.2 Transport connections between ATN ES are not linked to a particular subnetwork and ISO 8473 network protocol data units transmitted by an ES can pass via any air-ground ATN compatible subnetwork (such as aeronautical mobile-satellite service (AMSS) data link, SSR Mode S data link or VDL) that meets the quality of service (QOS) requirements. A transport connection between an aircraft ES and a ground ES shall be maintained as long as there is at least one air-ground subnetwork connection between the aircraft IS and a ground IS which has connectivity to the ground ES. In order to maximize subnetwork connectivity, aircraft are expected to maintain air-ground subnetwork connections via any subnetwork (AMSS, Mode S or VDL) with which link layer connectivity can be established.

3.1.3 The VDL subnetwork provides connectivity in the form of switched virtual circuits between ISO 8208 data terminal equipment (DTE) entities of aircraft and ground-based ATN intermediate systems. Due to the fact that VHF signals

have only line-of-sight propagation, it is necessary for aircraft in flight to regularly establish link connections with new VDL ground stations in order to maintain VHF coverage. An established VDL virtual circuit between an aircraft DTE and a ground DTE is maintained through a controlled change to a ground station through which the ground DTE can be accessed.

3.1.4 VDL virtual circuits may be cleared when the aircraft or ground IS identifies a policy situation where the virtual circuit to the ground DTE is no longer necessary but this shall only happen if another VDL virtual circuit remains established. A policy situation is a situation where considerations other than coverage influence the decision to establish a connection. This could be, for example, a situation where an aircraft is within the designated operational coverage area of ground stations operated by different operators and a decision must be made with which operator to establish a connection. The case where an aircraft crosses a border between two States needs special attention. An aircraft has to establish a virtual circuit to the DTE in the IS of the State entered before clearing the virtual circuit with the DTE in the IS of the State left.

3.1.5 The scenarios for subnetwork connection maintenance are shown in Figure ATT I-1*. If the ground stations on each side of a State border do not offer ISO 8208 connectivity to the DTEs of the IS in both States, aircraft crossing the border will have to set up a link connection to a ground station in the State entered before being able to establish a virtual circuit to the IS of that State. Only after establishment of the new link connection and virtual circuit, the aircraft will clear the virtual circuit with the DTE of the IS of the country left over the link which gave access to that IS. If the VDL aeronautical stations on both sides of the State border offer connectivity to the IS in both States, the changeover of the virtual circuits has to take place over the same link connection.

3.2 VDL quality of service for ATN routing

3.2.1 The use of the VDL system for air-ground communications will depend on the routing decisions of aircraft and ground-based ATN IS. These ISs will decide on the path to be used for air-ground communications based on quality of service values requested by transmitting ESs.

3.2.2 The IS at each end of the air-ground connections must interpret the requested QOS value and decide which of the available connections can best be met. It is important that the level of QOS which a VDL connection is perceived as providing is set at a level which corresponds to its true performance.

3.2.3 In cases where the VDL is the only data link with which an aircraft has been equipped, all communications must be routed via a VDL connection and the value set for QOS to be provided by the connection must not block the communication.

3.2.4 In other cases where aircraft are equipped with other air-ground data links (such as AMSS and SSR Mode S) there may be simultaneous parallel connections over multiple subnetworks. In these cases, the values for QOS provided by each subnetwork must be set so as to ensure that the VDL connection will be used where appropriate.

3.2.5 It is necessary that coordination take place between aircraft operators, ground station operators and ground system operators to ensure that the right balance is achieved between different subnetworks.

4. VDL GROUND STATION NETWORK CONCEPT

4.1 Access

4.1.1 A VDL ground station will provide access for aircraft to the ground ATN IS using the VDL protocol over a VHF channel.

* The figure is located at the end of this attachment.

4.2 Institutional issues concerning VDL ground station network operators

4.2.1 An ATS provider wishing to use VDL for air traffic service (ATS) communications needs to ensure that the VDL service is available. The ATS provider can either operate the VDL ground station network itself or arrange for the operation of the VDL stations (or VDL network) by a telecommunications service provider. It seems likely that individual States will make different arrangements for the provision of VDL service to aircraft. Operation and implementation of VDL need to be coordinated at a regional level in order to ensure acceptable service on international routes.

4.2.2 The use of a VDL ground station network by entities external to the ATS provider will be subject to service agreements between the ATS provider and the telecommunications service provider. These agreements set out the obligations of the two parties and need, in particular, to be specific on the quality of service provided as well as the characteristics of the user interface.

4.2.3 It seems likely that some VDL ground station network operators will levy user charges. These are expected to be levied either on the aircraft operators and/or on the ATS providers. It is necessary to ensure that the use of VDL is feasible for those aircraft operators intended to use VDL for ATS/AOC communications.

4.3 VDL ground station equipment

4.3.1 A VDL ground station will consist of a VHF radio and a computer which may be separate or integrated with the radio. The VDL functionality of the VHF radio equipment will be similar to that installed in aircraft.

4.3.2 The provision of network status monitoring is an important element in the maintenance of the highest availability possible.

4.4 Ground station siting

4.4.1 The line of sight limitations of VHF propagation is an important factor in the siting of ground stations. It is necessary to ensure that the ground stations are installed in a manner which provides coverage throughout the designated operational coverage area (DOC).

4.4.2 The coverage requirements for VDL depend on the applications that are intended to operate over the VDL. These applications may function, for example, when an aircraft is at en-route altitude, in a terminal area or on the ground at an airport.

4.4.3 En-route coverage can be provided using a small number of ground stations with a large DOC (for example, the range of a VHF signal from a station at sea level and an aircraft at 37 000 ft is approximately 200 NM). Hence, it is in fact desirable that the smallest number of ground stations possible be used to provide en-route coverage in order to minimize the possibility of simultaneous uplink transmissions from ground stations which may cause message collisions on the VHF channel. The factors limiting en-route coverage will be availability of landmass and the availability of a communications link from a ground station to other ground systems.

4.4.4 Terminal area coverage requires, in general, the installation of ground stations at all airports where VDL operation is required in order to ensure coverage throughout the terminal area.

4.4.5 Aerodrome surface communication coverage must be provided by a ground station at the airport but, due to the physical structure of the airport, it may not be possible to guarantee coverage in all areas with a single station.

4.5 Ground station frequency engineering

4.5.1 The choice of the VHF channel on which a ground station will operate depends on the coverage that the ground station will be required to provide. Coverage on a particular channel is provided by a collection of ground stations operating on that channel and the communications on that channel will occupy the channel for all the ground stations in a coverage area.

4.5.2 As with VHF voice communications, VDL communications cannot be limited to propagating only within States, and frequency coordination between States will be required in the allocation of VDL frequencies. The nature of the protocol does, however, allow for frequency re-use by several ground stations within the same coverage area and hence the rules for the assignment of frequencies are not the same as for voice communications.

4.5.3 The carrier sense multiple access (CSMA) media access control protocol (MAC) layer used in VDL cannot exclude message collisions if some stations using a frequency channel cannot receive the transmissions of other stations, a situation known as a hidden transmitter situation. Hidden transmitters lead to simultaneous transmissions which can cause the intended receiver of one or both transmissions to be unable to decode the received signal.

4.5.4 A frequency will be assigned to providing en-route coverage and all the en-route stations will be set to operate on this frequency. In order to minimize the probability of simultaneous transmissions on the channel by hidden transmitters in a CSMA environment, this channel may not be used for terminal area or aerodrome surface communications except in areas of very low channel loading.

4.5.5 The VDL SARPs call for the provision of a common signalling channel (CSC) on which access to VDL service will be guaranteed in all areas where VDL Mode 2 service is available. This is especially important at airports and on the edge of VDL en-route coverage zones where aircraft are likely to establish initial VDL connectivity. Since the characteristics of Mode 1 and Mode 2 radio frequency transmissions are not compatible, the CSC cannot be used for Mode 1 communications. There is no requirement for a CSC for VDL Mode 1.

4.6 Ground station connection to intermediate systems

4.6.1 In order to provide access to the ground systems which are connected to the aeronautical telecommunications network, a VDL ground station needs to be connected to one or more ATN IS. The purpose of a VDL ground station is to interconnect aircraft with the ground-based ATN via which communications with terrestrial ATN ES can take place.

4.6.2 The ground-based ATN IS can be co-hosted in the VDL ground station computer in which case the VDL subnetwork virtual circuit will end in that computer. This architecture will have an impact on the exchanges required when an aircraft establishes a VDL link with a new ground station. The exact exchange will depend on whether the ground stations contain separate IS or elements of the same distributed intermediate system.

4.6.3 If the IS is not contained in the VDL ground station, it will be connected to the ground station by one of the following means:

- a) wide area network (WAN);
- b) local area network (LAN); and
- c) dedicated communications line.

4.6.4 In all cases, in order to be in accordance with the *Manual of the Aeronautical Telecommunication Network (ATN)* (Doc 9578) for providing an open systems interconnection (OSI) compatible connection-oriented subnetwork service between the aircraft IS and the ground-based IS, the VDL ground station computer will be required to extend the VDL virtual circuit across the terrestrial network or link.

4.6.5 In order to provide simultaneous virtual circuits to several terrestrial ISs, the VDL ground station computer needs to contain a VDL subnetwork entity capable of converting addresses in VDL subnetwork call requests into addresses in the ground-based network.

5. VDL AIRBORNE OPERATING CONCEPT

5.1 Avionics

5.1.1 *VDL avionics.* In order to operate in a VDL network, aircraft need to be equipped with an avionics system providing the VDL subnetwork user (ISO 8208 DTE) function. The system providing this function will also provide the subnetwork user functions for the other air-ground ATN-compatible subnetworks and the aircraft ATN intermediate system function and, hence, its development is necessary in order to provide ATN communications to multiple end-systems or over multiple air-ground subnetworks.

5.2 VDL avionics certification

5.2.1 The VHF digital radio may also provide for double-side band amplitude modulation (DSB-AM) voice capability for emergency back-up to VHF radios used for voice communications. It would be necessary in this case to demonstrate that the VDL functionality of the VDR does not interfere with the DSB-AM voice functionality.

5.2.2 The VDL function in the VHF digital radio provides an air-ground data link service to the VDL subnetwork user entity of the aircraft ATN intermediate system. If the provision of a VHF subnetwork service to an ATN intermediate system were considered an essential service for a particular installation, the VDL functionality of the VDR would need to be certified as an essential function. The use of VDL for ATS communications is not, however, intended to require two aircraft radios to operate simultaneously in VDL mode.

5.3 Registration of aircraft with VDL network operators

5.3.1 For normal communications service, it is to be expected that aircraft operators will be required to register their aircraft with the network operators. In emergency or back-up situations, it must be possible for any VDL-equipped aircraft to establish connectivity over any VDL ground station network.

5.3.2 Registration of aircraft VDL stations with VDL network operators is desirable for network management since, for example, a network operator may identify a temporary fault in the VDL communications from an aircraft and would wish to contact the operator of the aircraft in order to have the fault resolved. Registration of aircraft is also useful in planning the required ground station network capacity. Registration with a VDL ground station network operator does not necessarily imply that the aircraft operator will be charged for use of the VDL ground station network.

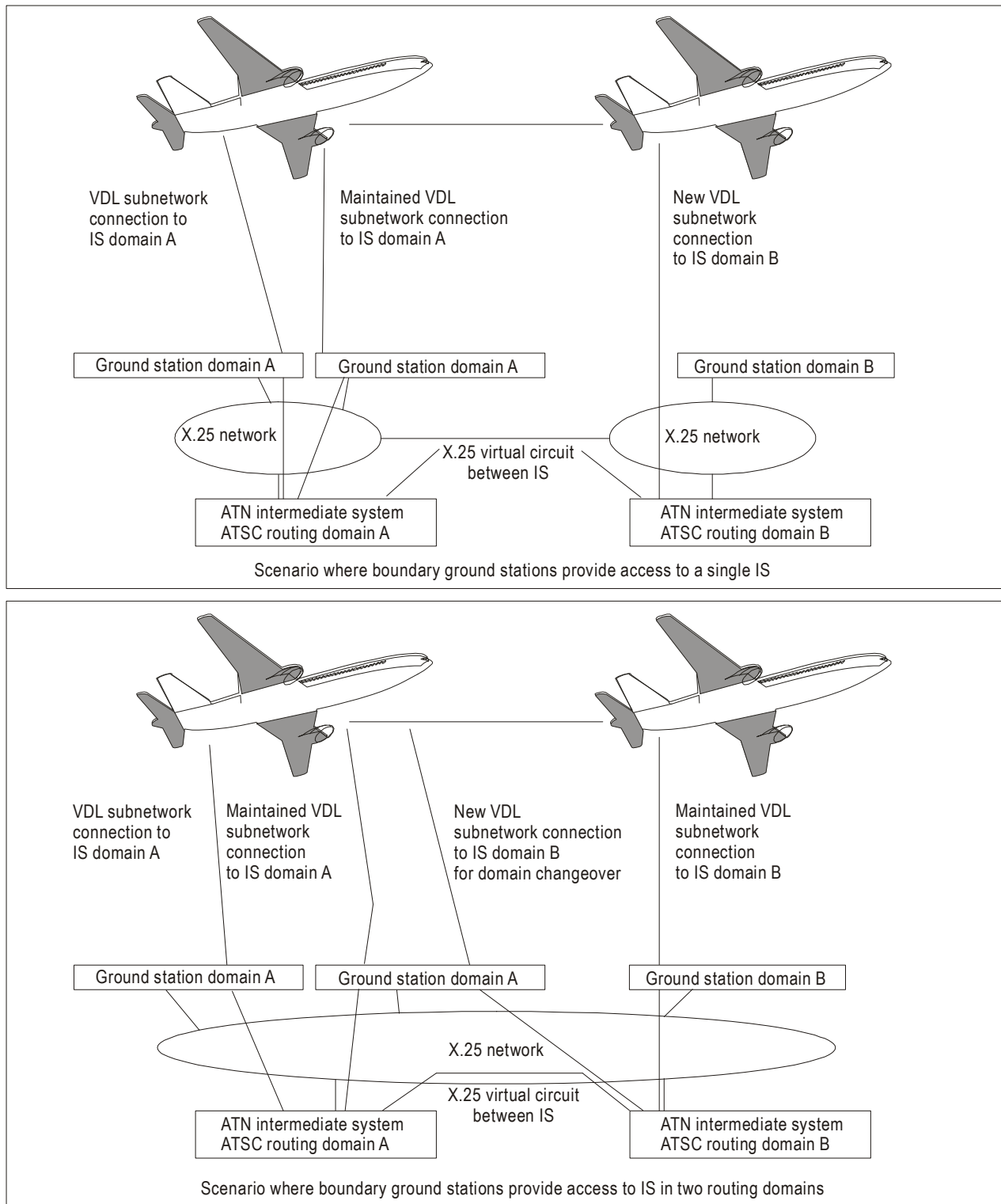

Figure ATT I-1.

ATTACHMENT TO PART II. GUIDANCE MATERIAL FOR COMMUNICATION SYSTEMS

1. VHF COMMUNICATIONS

1.1 Audio characteristics of VHF communication equipment

1.1.1 The aeronautical radiotelephony services represent a special case of the application of radiotelephony, in that the requirement is for the transmission of messages in such a way that fidelity of wave form is of secondary importance, emphasis being upon fidelity of basic intelligence. This means that it is not necessary to transmit those parts of the wave form which are solely concerned with individuality, accent and emphasis.

1.1.2 The effective acceptance bandwidth for 8.33 kHz equipment is required to be at least plus and minus 3 462 Hz. This value considers the general case, i.e. air-to-ground transmissions and consists of 2 500 Hz audio bandwidth, 685 Hz for an aircraft transmitter instability of 5 ppm, 137 Hz for a ground receiver instability of 1 ppm and 140 Hz due to Doppler shift (2.2.2.4 and 2.3.2.6 of Part II refer).

1.2 Offset carrier system in 25 kHz, 50 kHz and 100 kHz spaced channels

The following are examples of offset carrier systems which meet the requirements of Part II, 2.2.1.1.1.

- a) *2-carrier system.* Carriers should be spaced at plus and minus 5 kHz. This requires a frequency stability of plus or minus 2 kHz (15.3 parts per million at 130 MHz).
- b) *3-carrier system.* Carriers should be spaced at zero and plus and minus 7.3 kHz. This requires a frequency stability of plus or minus 0.65 kHz (5 parts per million at 130 MHz).

The following are examples of 4- and 5-carrier systems which meet the requirements of Part II, 2.2.1.1.1.

- c) *4-carrier system.* Carriers should be spaced at plus and minus 2.5 kHz and plus and minus 7.5 kHz. This requires a frequency stability of plus or minus 0.5 kHz (3.8 parts per million at 130 MHz).
- d) *5-carrier system.* Carriers should be spaced at zero, plus and minus 4 kHz and plus and minus 8 kHz. A frequency stability in the order of plus or minus 40 Hz (0.3 parts per million at 130 MHz) is an achievable and practicable interpretation of the requirement in this case.

Note 1.— The carrier frequency spacings referred to above are with respect to the assigned channel frequency.

Note 2.— In aircraft receivers which employ a measurement of the received carrier-to-noise ratio to operate the mute, the audio heterodynes caused by the reception of two or more off-set carriers can be interpreted as noise and cause the audio output to be muted even when an adequate wanted signal is present. In order that the airborne receiving system can conform with the sensitivity recommendations contained in Part II, 2.3.2.2, the design of the receivers may need to ensure that their sensitivity is maintained at a high level when receiving off-set carrier transmissions. The use of a carrier level override is an unsatisfactory solution to this requirement, but where it is employed, setting the override level as low as possible can ameliorate the problem.

1.3 Immunity performance of COM receiving systems in the presence of VHF FM broadcast interference

1.3.1 With reference to the Note of 2.3.3.2 of Part II, the immunity performance defined there must be measured against an agreed measure of derogation of the receiving system's normal performance, and in the presence of, and under standard conditions for the input wanted signal. This is necessary to ensure that the checking of receiving station equipment on bench test can be performed to a repeatable set of conditions, and results, and to facilitate their subsequent approval. An adequate measure of immunity performance may be obtained by the use of wanted signal of minus 87 dBm into the receiving equipment and the signal modulated with a 1 kHz tone at 30 per cent modulation depth. The signal-to-noise ratio should not fall below 6 dB when the interfering signals specified at Part II, 2.3.3.1 and 2.3.3.2 are applied. The broadcast signals should be selected from frequencies in the range between 87.5 and 107.9 MHz and should be modulated with a representative broadcast type signal.

Note 1.— The signal level of minus 87 dBm assumes a combined antenna and feeder gain of 0 dB.

Note 2.— The reduction in the signal-to-noise ratio quoted above is for the purpose of standardization when checking that receiving station equipment on bench measurements meet the required immunity. In the planning of frequencies and in the assessment of protection from FM broadcast interference, a value not less than this, and in many cases higher, depending on the operational circumstances in individual cases, should be chosen as the basis of the interference assessment.

2. SELCAL SYSTEM

2.1 This material is intended to provide information and guidance relating to the operation of the SELCAL system. It is associated with the Recommended Practices contained in Part II, Chapter 3.

- a) *Function.* The purpose of the SELCAL system is to permit the selective calling of individual aircraft over radiotelephone channels linking the ground station with the aircraft, and is intended to operate on en-route frequencies with existing HF and VHF ground-to-air communications transmitters and receivers with a minimum of electrical and mechanical modification. The normal functioning of the ground-to-air communications link should be unaffected, except at such time as the selective calling function is being formed.
- b) *Principles of operation.* Selective calling is accomplished by the coder of the ground transmitter sending a single group of coded tone pulses to the aircraft receiver and decoder. The airborne receiver and decoder equipment is capable of receiving and interpreting, by means of an indicator, the correct code and rejecting all other codes in the presence of random noise and interference. The ground portion of the coding device (ground selective calling unit) supplies coded information to the ground-to-air transmitter. The airborne selective calling unit is the special airborne equipment which operates with existing communications receivers on the aircraft to permit decoding of the ground-to-air signals for display on the signal indicator. The type of signal indicator can be chosen to suit operational requirements of the user and may consist of a lamp, a bell, a chime or any combination of such indicating devices.

— END —

© ICAO 2007
8/07, E/P1/2200

Order No. AN10-3
Printed in ICAO

